



Sistemas integrados  
para puertas  
correderas ocultas,  
manillas y accesorios

Lista de precios 2021



10\_2021

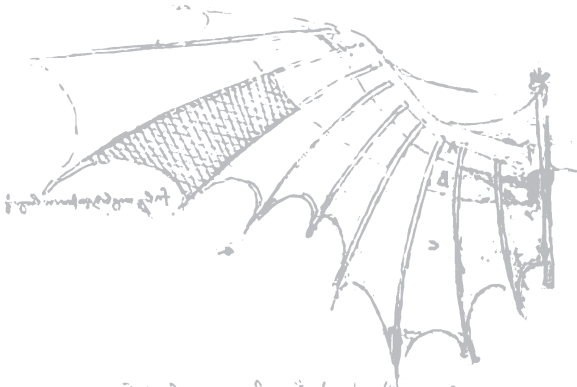

A  
B  
C

Handwritten text, likely a legend or description, oriented upside down relative to the drawing above it.

# INDICE

## REVOLUCION

■	Krona Hoja Única	4
■	Krona Hoja Única Especial	4
■	Krona Hoja Paralela	5
■	Krona Hoja Convergente	5
■	Krona Hoja Paralela y Convergente	6
■	Ego Batiente	13/17
■	Ego Kuadro	22
■	Ego Swing Life	24

## CARTONES

■	Kit Futura	7
■	Mekkit 3D	8
■	Kompatto	12
■	Ego Batiente	15/19
■	Ego Kuadro	23
■	Ego Swing Life	25

■	■	Accesorios	26
■	■	Módulo de pedido	27
■	■	Condiciones Generales de Venta	31

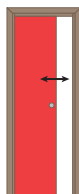

Medidas Estandar  
marcadas en color rojo.

- ABS en el cierre: opcional

- Ancho max 1400 mm.

- Para los armazones con travesaño diferente del estándar se aplicará el precio del correspondiente armazón de medida especial en altura.

- Para medidas 650, 750, 850, 950 pedir presupuesto a Krona.

Para medidas mayores 1200 pedir la factibilidad a Krona

• Para ancho de 1300 a 1400, se pide confirmación de pedido firmada por el cliente, juntamente con un exonerado de responsabilidad de Krona.

## Armazón Krona

Luz de paso Ancho	Luz de paso Altura	Espes. Pared Term.	Ancho Interno	Espes. Puerta max	CODIGO	€	Bultos
600	2020	90	52	40	1101 E 90	314,93	1
		105	67	55	1101 E 105	314,93	1
		125	87	55	1101 E 120	401,22	1
	2100	90	52	40	1102 90	314,93	1
		105	67	55	1102 105	314,93	1
		125	87	55	1102 125	401,22	1
700	2020	90	52	40	1103 E 90	336,62	1
		105	67	55	1103 E 105	336,62	1
		125	87	55	1103 E 120	428,94	1
	2100	90	52	40	1104 90	336,62	1
		105	67	55	1104 105	336,62	1
		125	87	55	1104 125	428,94	1
750	2020	90	52	40	1103 5 E 90	343,22	1
		105	67	55	1103 5 E 105	343,22	1
		125	87	55	1103 5 E 120	457,76	1
	2100	90	52	40	1104 5 90	343,22	1
		105	67	55	1104 5 105	343,22	1
		125	87	55	1104 5 120	457,76	1
800	2020	90	52	40	1105 E 90	350,32	1
		105	67	55	1105 E 105	350,32	1
		125	87	55	1105 E 120	457,76	1
	2100	90	52	40	1106 90	350,32	1
		105	67	55	1106 105	350,32	1
		125	87	55	1106 125	457,76	1
900	2020	90	52	40	1107 E 90	393,72	1
		105	67	55	1107 E 105	393,72	1
		125	87	55	1107 E 120	470,48	1
	2100	90	52	40	1108 90	393,72	1
		105	67	55	1108 105	393,72	1
		125	87	55	1108 125	470,48	1
1000	2020	90	52	40	1109 E 90	466,81	1
		105	67	55	1109 E 105	466,81	1
		125	87	55	1109 E 120	483,45	1
	2100	90	52	40	1110 90	466,81	1
		105	67	55	1110 105	466,81	1
		125	87	55	1110 120	483,45	1
1100	2020	90	52	40	1111 E 90	542,48	1
		105	67	55	1111 E 105	542,48	1
		125	87	55	1111 E 120	566,72	1
	2100	90	52	40	1112 90	542,48	1
		105	67	55	1112 105	542,48	1
		125	87	55	1112 120	566,72	1
1200	2020	90	52	40	1113 E 90	578,18	1
		105	67	55	1113 E 105	578,18	1
		125	87	55	1113 E 120	608,60	1
	2100	90	52	40	1114 90	578,18	1
		105	67	55	1114 105	578,18	1
		125	87	55	1114 120	608,60	1

## Armazón Krona

### Medidas Especiales

#### Altura Especial

Luz de paso Ancho	Luz de paso Altura	Espes. Pared Term.	Ancho Interno	Espes. Puerta max	CODIGO	€	Bultos
600	2110-2700	105	67	55	1201 105	468,86	1
		125	87	55	1201 120	468,86	1
700	2110-2700	105	67	55	1202 105	468,86	1
		125	87	55	1202 120	468,86	1
800	2110-2700	105	67	55	1203 105	496,23	1
		125	87	55	1203 125	507,59	1
900	2110-2700	105	67	55	1204 105	522,01	1
		125	87	55	1204 120	533,46	1
1000	2110-2700	105	67	55	1205 105	659,61	1
		125	87	55	1205 120	683,76	1
1100	2110-2700	105	67	55	1206 105	729,08	1
		125	87	55	1206 120	752,73	1
1200	2110-2700	105	67	55	1207 105	785,26	1
		125	87	55	1207 125	803,24	1



Armazón Krona			Hoja Paralela Única 				
Luz de paso Ancho	Luz de paso Altura	Espes. Pared Term.	Ancho Interno	Espes. Puerta max	CODIGO	€	Bultos
1200	2020	170	132	55	2101 E	793,72	2
	2100	170	132	55	2102	793,72	2
1400	2020	170	132	55	2103 E	867,36	2
	2100	170	132	55	2104	867,36	2
1600	2020	170	132	55	2105 E	941,00	2
	2100	170	132	55	2106	910,00	2
1800	2020	170	132	55	2107 E	1.014,64	2
	2100	170	132	55	2108	1.014,64	2
2000	2020	170	132	55	2109 E	1.161,92	2
	2100	170	132	55	2110	1.161,92	2
2200	2020	170	132	55	2111 E	1.235,56	2
	2100	170	132	55	2112	1.235,56	2
2400	2020	170	132	55	2113 E	1.293,93	2
	2100	170	132	55	2114	1.293,93	2

Armazón Krona			Hoja Paralela Doble 				
Luz de paso Ancho	Luz de paso Altura	Espes. Pared Term.	Ancho Interno	Espes. Puerta max	CODIGO	€	Bultos
2400	2020	170	132	55	2201 E	1.587,42	3
	2100	170	132	55	2202	1.587,42	3
2800	2020	170	132	55	2203 E	1.734,70	3
	2100	170	132	55	2204	1.734,70	3
3200	2020	170	132	55	2205 E	1.881,99	3
	2100	170	132	55	2206	1.881,99	3
3600	2020	170	132	55	2207	1.911,63	3
	2100	170	132	55	2208	1.911,63	3
4000	2020	170	132	55	2209	2.308,56	3
	2100	170	132	55	2210	2.308,56	3
4400	2020	170	132	55	2211	2.455,84	3
	2100	170	132	55	2212	2.455,84	3
4800	2020	170	132	55	2213	2.603,12	3
	2100	170	132	55	2214	2.603,12	3

Armazón Krona			Hoja Convergente 				
Luz de paso Ancho	Luz de paso Altura	Espes. Pared Term.	Ancho Interno	Espes. Puerta max	CODIGO	€	Bultos
600+600	2020	170	132	55	2301	855,04	2
	2100	170	132	55	2302	855,04	2
700+700	2020	170	132	55	2303	952,36	2
	2100	170	132	55	2304	952,36	2
800+800	2020	170	132	55	2305	1.023,81	2
	2100	170	132	55	2306	1.023,81	2
900+900	2020	170	132	55	2307	1.108,81	2
	2100	170	132	55	2308	1.108,81	2
1000+1000	2020	170	132	55	2309	1.208,59	2
	2100	170	132	55	2310	1.208,59	2
1100+1100	2020	170	132	55	2311	1.284,10	2
	2100	170	132	55	2312	1.284,10	2
1200+1200	2020	170	132	55	2313	1.367,00	2
	2100	170	132	55	2314	1.367,00	2



## Armazón Krona Medidas Especiales

Hoja Paralela Única

### Altura Especial

Luz de paso Ancho	Luz de paso Altura	Espes. Pared Term.	Ancho Interno	Espes. Puerta max	CODIGO	€	Bultos
1200	2110-2700	170	132	55	2115	941,00	2
1400	2110-2700	170	132	55	2116	1.029,92	2
1600	2110-2700	170	132	55	2117	1.117,46	2
1800	2110-2700	170	132	55	2118	1.206,38	2
2000	2110-2700	170	132	55	2119	1.382,83	2
2200	2110-2700	170	132	55	2120	1.471,78	2
2400	2110-2700	170	132	55	2121	1.559,32	2

## Armazón Krona Medidas Especiales

Hoja Paralela Doble

### Altura Especial

Luz de paso Ancho	Luz de paso Altura	Espes. Pared Term.	Ancho Interno	Espes. Puerta max	CODIGO	€	Bultos
2400	2110-2700	170	132	55	2215	1.881,99	3
2800	2110-2700	170	132	55	2216	2.058,44	3
3200	2110-2700	170	132	55	2217	2.234,93	3
3600	2110-2700	170	132	55	2218	2.411,38	3
4000	2110-2700	170	132	55	2219	2.765,70	3
4400	2110-2700	170	132	55	2220	2.942,15	3
4800	2110-2700	170	132	55	2221	3.118,62	3

## Armazón Krona Medidas Especiales

Hoja Convergente

### Altura Especial

Luz de paso Ancho	Luz de paso Altura	Espes. Pared Term.	Ancho Interno	Espes. Puerta max	CODIGO	€	Bultos
600+600	2110-2700	170	132	55	2315	1.033,67	3
700+700	2110-2700	170	132	55	2316	1.119,90	3
800+800	2110-2700	170	132	55	2317	1.206,12	3
900+900	2110-2700	170	132	55	2318	1.300,99	3
1000+1000	2110-2700	170	132	55	2319	1.452,50	3
1100+1100	2110-2700	170	132	55	2320	1.539,97	3
1200+1200	2110-2700	170	132	55	2321	1.686,16	3

## ACCESORIOS de deslizamiento para armazón

Descripción	CODIGO	€	Paquete mín.
<b>Grapas de unión para armazón Krona</b>			
Grapa de unión para hoja doble 1200x90	9002 120 90	46,26	1
Grapa de unión para hoja doble 1400x90	9002 140 90	46,26	1
Grapa de unión para hoja doble 1600x90	9002 160 90	46,26	1
Grapa de unión para hoja doble 1800x90	9002 180 90	46,26	1
Grapa de unión para hoja doble 2000x90	9002 200 90	46,26	1
Grapa de unión para hoja doble 1200x105	9002 120 105	46,26	1
Grapa de unión para hoja doble 1400x105	9002 140 105	46,26	1
Grapa de unión para hoja doble 1600x105	9002 160 105	46,26	1
Grapa de unión para hoja doble 1800x105	9002 180 105	46,26	1
Grapa de unión para hoja doble 2000x105	9002 200 105	46,26	1
Grapa de unión para hoja doble 1200x125	9002 120 120	46,26	1
Grapa de unión para hoja doble 1400x125	9002 140 120	46,26	1
Grapa de unión para hoja doble 1600x125	9002 160 120	46,26	1
Grapa de unión para hoja doble 1800x125	9002 180 120	46,26	1
Grapa de unión para hoja doble 2000x125	9002 200 120	46,26	1



**Armazón para cartónyeso**

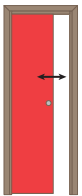

**\*Medidas especiales**

- ABS en el cierre: *opcional*
- ABS en la apertura: *opcional*

**Krona Kit Futura - Cartónyeso**

**Hoja Única**

Luz de paso Ancho	Luz de paso Altura	Espes. Pared Terr.	Ancho Interno	Espes. Puerta max	CODIGO	€	Bultos
600-1000	2020	100	47	40	5000 E 95	<b>260,81</b>	1
		120	67	55	5000 E 115	<b>260,81</b>	1
	2100	100	47	40	5001 95	<b>260,81</b>	1
		120	67	55	5001 115	<b>260,81</b>	1
	*2110-2400	120	67	55	5002 115	<b>548,44</b>	1

**Krona Kit Futura - Cartónyeso**

**Hoja Doble** |

HOJA DOBLE = 2 Krona Kit Futura

Ejemplo: 1600 x 2100 x 115 Hoja Doble = nr. 2 Krona Kit Futura 5001 115

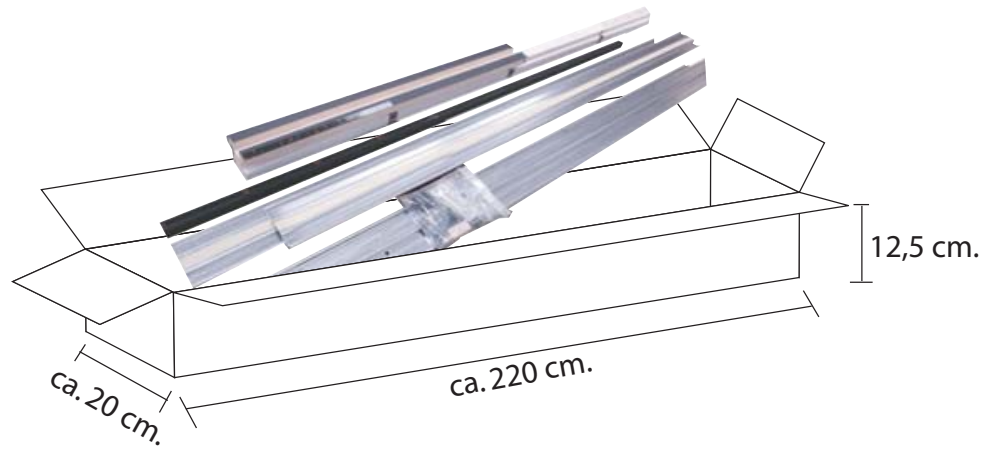



# mekhit3D

PAT-PENDING

## Armazón en kit para cartón yeso



Mekhit3D es el nuevo Kit para puertas correderas para paredes de cartón yeso.

3D porque es regulable en las 3 dimensiones gracias a los elementos que vienen incluidos en el kit: altura, ancho y espesor.

Combinando el kit base del Mekhit3D, es posible realizar 3 soluciones diferentes de instalación:

- Con puerta tradicional y jambas de madera
- EGO 1 con puerta sin jambas ni marcos.
- EGO 2 con puerta sin jambas ni marcos con altura suelo/techo.

Mekhit3D es un kit con freno ABS de serie (en cierre).



### 1 producto, 3 soluciones!!



# mekhit3D

PAT-PENDING

KIT Base



1 - KIT Jambas Solución puerta tradicional: Jambas y marcos en madera.

1 - Solución puerta tradicional: Jambas y marcos en madera.



2 - KIT EGO MODEL 1

2 - EGO Model 1: puerta rasomuro sin jambas ni marcos.



3 - KIT EGO MODEL 2

3 - EGO Model 2: con puerta suelo/techo.

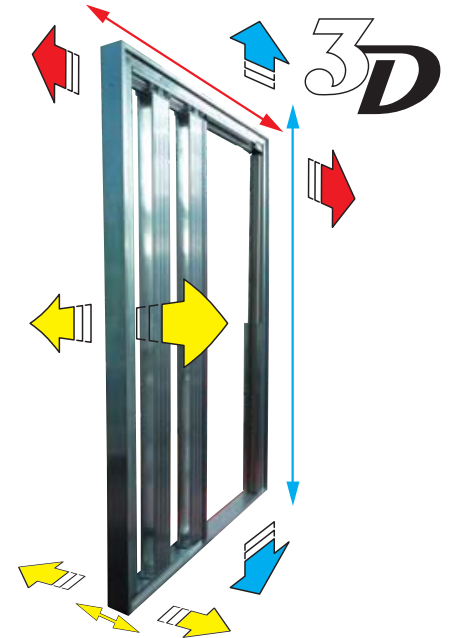





**Note:**

\*Medidas especiales

- ABS en el cierre: de serie
- Espesor 100 y 125 mm incluidos en el Kit Base
- Para alturas inferiores a las estandar, utilizar la primera opción del medida especial.

## KIT BASE

### PREMARCO

#### MEKKIT 3D Kit BASE Estandar Cartónyeso

ANCHO	ALTURA	espesor pared term.	CODIGO	€	Bultos
600-1000	2020	100	8000.0.00.100 ES	377,71	1
600-1000	2100	100	8000.0.01.100 ES	377,71	

#### MEKKIT 3D Kit BASE Medidas Especiales Cartónyeso

ANCHO	ALTURA	espesor pared term.	CODICE	€	Bultos
590-1010	*2101-2400	100	8000.0.01.100	431,66	1
		125	8000.0.01.125	431,66	
	*2401-2700	125	8000.0.02.125	485,61	
1011-1310	1975-2100	100	8000.0.10.100	415,47	1
		125	8000.0.10.125	415,47	
	*2101-2400	100	8000.0.11.100	469,43	
		125	8000.0.11.125	469,43	
	*2401-2700	125	8000.0.12.125	523,38	
	*2701-3000	125	8000.0.13.125	539,56	
1311-1810	1975-2100	125	8000.0.20.125	528,78	1
	*2101-2400	125	8000.0.21.125	636,69	
	*2401-2700	125	8000.0.22.125	674,47	
	*2701-3000	125	8000.0.23.125	744,62	

#### MEKKIT 3D Hoja Doble Cartónyeso

Los kit MEKKIT 3D HOJA ÚNICA, están ya preparados para ser acoplados entre sí y obtener el sistema de HOJA DOBLE.



**Note:**  
\*Medidas especiales  
- ABS en el cierre: de serie  
- Espesor 100 y 125 mm incluidos en el Kit Base  
- Para alturas inferiores a las estandard, utilizar la primera opción del medida especial.

## ACCESORIOS

### KIT DE ACABADO

#### MEKKIT 3D Puerta Tradicional Hoja Única Cartónyeso

ANCHO	ALTURA	espesor pared term.	CODIGO	€	Bultos
1030	2100	100	8000.1.00.100.AU	124,10	1
		125	8000.1.00.125.AU	129,50	
	*2400	100	8000.1.01.100.AU	156,47	
		125	8000.1.01.125.AU	161,87	
	*2700	125	8000.1.02.125.AU	172,65	

#### MEKKIT 3D Puerta Tradicional Hoja Doble Cartónyeso

ANCHO	ALTURA	espesor pared term.	CODIGO	€	Bultos
2065	2100	100	8000.1.00.100.AD	129,50	1
		125	8000.1.00.125.AD	129,50	
	*2400	100	8000.1.01.100.AD	140,29	
		125	8000.1.01.125.AD	140,29	
	*2700	125	8000.1.02.125.AD	151,01	

#### MEKKIT 3D EGO Mod. 1 Hoja Única Cartónyeso

ANCHO	ALTURA	espesor pared term.	CODIGO	€	Bultos
1200	2100	100	8000.3.00.100.AU	226,41	1
		125	8000.3.00.125.AU	226,41	

#### MEKKIT 3D EGO Mod. 1 Hoja Doble Cartónyeso

ANCHO	ALTURA	espesor pared term.	CODIGO	€	Bultos
2400	2100	100	8000.3.00.100.AD	212,93	1
		125	8000.3.00.125.AD	212,93	

#### MEKKIT 3D EGO Mod. 2 Hoja Única Cartónyeso

ANCHO	ALTURA	espesor pared term.	CODIGO	€	Bultos
-	2100	100	8000.4.00.100.AU	185,94	1
		125	8000.4.00.125.AU	185,94	

#### MEKKIT 3D EGO Mod. 2 Hoja Doble Cartónyeso

ANCHO	ALTURA	espesor pared term.	CODIGO	€	Bultos
-	2100	100	8000.4.00.100.AD	105,01	1
		125	8000.4.00.125.AD	105,01	

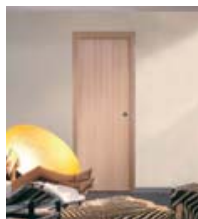

**Note:**

\*Medidas especiales

- ABS en el cierre: de serie

- Espesor 100 y 125 mm  
incluidos en el Kit Base

- Para alturas inferiores a las  
estándar, utilizar la primera  
opción del medida especial.

## KIT BASE + ACCESORIOS

### ARMAZÓN + KIT DE ACABADO

#### MEKKIT 3D EGO Mod. 1 Hoja Única Cartónyeso

ANCHO	ALTURA	espesor pared term.	CODIGO	€	Bultos
0-1200	*2101-2400	100	8000.3.01.100.AU	728,42	2
		125	8000.3.01.125.AU	728,42	
	*2401-2700	125	8000.3.02.125.AU	755,40	
	*2701-3000	125	8000.3.03.125.AU	782,39	

#### MEKKIT 3D EGO Mod. 1 Hoja Doble Cartónyeso

ANCHO	ALTURA	espesor pared term.	CODIGO	€	Bultos
0-2400	*2101-2400	100	8000.3.01.100.AD	1.241,03	2
		125	8000.3.01.125.AD	1.241,03	
	*2401-2700	125	8000.3.02.125.AD	1.270,32	
	*2701-3000	125	8000.3.03.125.AD	1.321,96	

#### MEKKIT 3D EGO Mod. 2 Hoja Única Cartónyeso

ANCHO	ALTURA	espesor pared term.	CODIGO	€	Bultos
0-1310	*2101-2400	100	8000.4.01.100.AU	620,51	2
		125	8000.4.01.125.AU	634,00	
	*2401-2700	125	8000.4.02.125.AU	647,49	
	*2701-3000	125	8000.4.03.125.AU	660,98	
1310-1800	*2401-2700	125	8000.4.22.125.AU	788,30	2

#### MEKKIT 3D EGO Mod. 2 Hoja Doble Cartónyeso

ANCHO	ALTURA	espesor pared term.	CODIGO	€	Bultos
0-2600	*2101-2400	100	8000.4.01.100.AD	1.187,06	2
		125	8000.4.01.125.AD	1.187,06	
	*2401-2700	125	8000.4.02.125.AD	1.214,04	
	*2701-3000	125	8000.4.03.125.AD	1.241,03	

## REPUESTOS

#### MEKKIT 3D Kit

Descripción	CODIGO	€	Bultos
Kit corredero 80kg ABS	8000.9.01	67,44	1
Kit corredero 80kg ABS 0600	8000.9.02	94,43	
Travesaño cartón yeso simple L1200	8000.9.03	67,44	
Confección para los tornillos autorroscantes 3.5x19 negros, 1000pz	8000.9.04	44,30	
Guía inferior	8000.9.05	4,07	
Goma/Cepillos	1803	35,98	



Armazón para cartónyeso

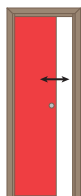

## Armazón Kompatto - Cartónyeso

Hoja Única

Luz de paso Ancho	Luz de paso Altura	Espes. Pared Term.	Ancho Interno	Espes. Puerta max	CODIGO	€	Bultos
600	2020	100	52	40	9.06022 95	<b>301,82</b>	1
		125	67	52	9.06022 115	<b>301,82</b>	1
	2100	100	52	40	9.0621 95	<b>301,82</b>	1
		125	67	52	9.0621 115	<b>301,82</b>	1
	*2110-2400	125	67	52	9.20624 115	<b>449,15</b>	1
700	2020	100	52	40	9.07022 95	<b>313,07</b>	1
		125	67	52	9.07022 115	<b>313,07</b>	1
	2100	100	52	40	9.0721 95	<b>313,07</b>	1
		125	67	52	9.0721 115	<b>313,07</b>	1
	*2110-2400	125	67	52	9.20724 115	<b>462,07</b>	1
800	2020	100	52	40	9.08022 95	<b>325,59</b>	1
		125	67	52	9.08022 115	<b>325,59</b>	1
	2100	100	52	40	9.0821 95	<b>325,59</b>	1
		125	67	52	9.0821 115	<b>325,59</b>	1
	*2110-2400	125	67	52	9.20824 115	<b>475,01</b>	1
900	2020	100	52	40	9.09022 95	<b>346,81</b>	1
		125	67	52	9.09022 115	<b>346,81</b>	1
	2100	100	52	40	9.0921 95	<b>346,81</b>	1
		125	67	52	9.0921 115	<b>346,81</b>	1
	*2110-2400	125	67	52	9.20924 115	<b>500,88</b>	1
1000	2020	100	52	40	9.10022 95	<b>390,68</b>	1
		125	67	52	9.10022 115	<b>390,68</b>	1
	2100	100	52	40	9.1021 95	<b>390,68</b>	1
		125	67	52	9.1021 115	<b>390,68</b>	1
	*2110-2400	125	67	52	9.21024 115	<b>551,33</b>	1
*1100	*2020	125	67	65	9.11022 115	<b>507,35</b>	1
	*2100	125	67	65	9.1121 115	<b>507,35</b>	1
	*2110-2400	125	67	65	9.21124 115	<b>636,69</b>	1
*1200	*2020	125	67	65	9.12022 115	<b>546,15</b>	1
	*2100	125	67	65	9.1221 115	<b>546,15</b>	1
	*2110-2400	125	67	65	9.21224 115	<b>675,50</b>	1

## Armazón Kompatto - Cartónyeso

Hoja Doble

HOJA DOBLE = 2 Kompatto

Ejemplo: 1600 x 2100 x 100 Hoja Doble = nr. 2 Kompatto + grapa de unión.

Descripción	CODIGO	€	Bultos
Kit accesorios Krona 50/80 Kg. Kompatto	9002	<b>28,24</b>	1
Grapa de unión Kompatto 1200x100	9002 120 100	<b>46,26</b>	1
Grapa de unión Kompatto 1400x100	9002 140 100	<b>46,26</b>	1
Grapa de unión Kompatto 1600x100	9002 160 100	<b>46,26</b>	1
Grapa de unión Kompatto 1800x100	9002 180 100	<b>46,26</b>	1
Grapa de unión Kompatto 2000x100	9002 200 100	<b>46,26</b>	1
Grapa de unión Kompatto 1200x125	9002 120 125	<b>46,26</b>	1
Grapa de unión Kompatto 1400x125	9002 140 125	<b>46,26</b>	1
Grapa de unión Kompatto 1600x125	9002 160 125	<b>46,26</b>	1
Grapa de unión Kompatto 1800x125	9002 180 125	<b>46,26</b>	1
Grapa de unión Kompatto 2000x125	9002 200 125	<b>46,26</b>	1

Utilizar la chapa de cartónyeso espesor 12,5 mm

\*Medidas especiales

- ABS en el cierre: opcional

Por distintas razones productivas, los armazones de medidas especiales pueden tener características estructurales diferentes.

### Batiente Revoque



EGO es la nueva puerta batiente sin jambas ni tapajuntas, con un diseño puramente minimalista. EGO es la única solución del mercado a ras de la pared que tiene un armazón compuesto de un único elemento! La peculiaridad del modelo EGO con panel batiente es la presencia de la bisagra KUBICA "K6200" que permite regular la puerta en sus tres ejes.

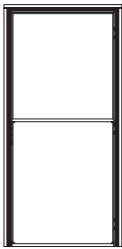

- Formado por: premarco soldado + Kubica K6200

Para medidas no Standard, se ruega preguntar la factibilidad de las mismas a Krona.

\*Medidas especiales

### EGO Batiente perfil único para revoque (premarco soldado + Kubica K6200)

ANCHO	ALTURA	espesor pared term.	CODIGO	€	Bultos				
600	2020 2100	90	77.030 0621 90 DX S	642,21	1				
			77.030 0621 90 DX T						
			77.030 0621 90 SX S						
			77.030 0621 90 SX T						
			77.030 0621 DX S						
			77.030 0621 DX T						
	*2110 *2400	105	77.030 0621 SX S						
			77.030 0621 SX T						
			77.030 0624 90 DX S						
			77.030 0624 90 DX T						
			77.030 0624 90 SX S						
			77.030 0624 90 SX T						
	*2410 *2700	90	77.030 0624 DX S			747,07	1		
			77.030 0624 DX T						
			77.030 0624 SX S						
			77.030 0624 SX T						
			77.030 0627 90 DX S						
			77.030 0627 90 DX T						
*2410 *2700	105	77.030 0627 90 SX S	904,33	1					
		77.030 0627 90 SX T							
		77.030 0627 DX S							
		77.030 0627 DX T							
		77.030 0627 SX S							
		77.030 0627 SX T							
700	2020 2100	90			77.030 0721 90 DX S			642,21	1
					77.030 0721 90 DX T				
					77.030 0721 90 SX S				
					77.030 0721 90 SX T				
					77.030 0721 DX S				
					77.030 0721 DX T				
	*2110 *2400	105			77.030 0721 SX S	747,07	1		
					77.030 0721 SX T				
					77.030 0724 90 DX S				
					77.030 0724 90 DX T				
					77.030 0724 90 SX S				
					77.030 0724 90 SX T				
	*2410 *2700	90	77.030 0724 DX S	904,33	1				
			77.030 0724 DX T						
			77.030 0724 SX S						
			77.030 0724 SX T						
			77.030 0727 90 DX S						
			77.030 0727 90 DX T						
*2410 *2700	105	77.030 0727 90 SX S	904,33					1	
		77.030 0727 90 SX T							
		77.030 0727 DX S							
		77.030 0727 DX T							
		77.030 0727 SX S							
		77.030 0727 SX T							
800	2020 2100	90				77.030 0821 90 DX S	642,21		1
						77.030 0821 90 DX T			
						77.030 0821 90 SX S			
						77.030 0821 90 SX T			
						77.030 0821 DX S			
						77.030 0821 DX T			
	*2110 *2400	105		77.030 0821 SX S	747,07	1			
				77.030 0821 SX T					
				77.030 0824 90 DX S					
				77.030 0824 90 DX T					
				77.030 0824 90 SX S					
				77.030 0824 90 SX T					
	*2410 *2700	90	77.030 0824 DX S	904,33				1	
			77.030 0824 DX T						
			77.030 0824 SX S						
			77.030 0824 SX T						
			77.030 0827 90 DX S						
			77.030 0827 90 DX T						
*2410 *2700	105	77.030 0827 90 SX S	904,33				1		
		77.030 0827 90 SX T							
		77.030 0827 DX S							
		77.030 0827 DX T							
		77.030 0827 SX S							
		77.030 0827 SX T							

### Batiente Revoque



EGO es la nueva puerta batiente sin jambas ni tapajuntas, con un diseño puramente minimalista.

EGO es la única solución del mercado a ras de la pared que tiene un armazón compuesto de un único elemento!

La peculiaridad del modelo EGO con panel batiente es la presencia de la bisagra KUBICA "K6200" que permite regular la puerta en sus tres ejes.



### EGO Batiente perfil único para revoque (premarco soldado + Kubica K6200)

ANCHO	ALTURA	espesor pared term.	CODIGO	€	Bultos				
900	2020 2100	90	77.030 0921 90 DX S	617,51	1				
			77.030 0921 90 DX T						
			77.030 0921 90 SX S						
			77.030 0921 90 SX T						
			77.030 0921 DX S						
			77.030 0921 DX T						
	*2110 *2400	105	77.030 0921 SX S						
			77.030 0921 SX T						
			77.030 0924 90 DX S						
			77.030 0924 90 DX T						
			77.030 0924 90 SX S						
			77.030 0924 90 SX T						
	*2410 *2700	90	77.030 0924 DX S			747,07	1		
			77.030 0924 DX T						
			77.030 0924 SX S						
			77.030 0924 SX T						
			77.030 0927 90 DX S						
			77.030 0927 90 DX T						
*2410 *2700	105	77.030 0927 90 SX S	904,33	1					
		77.030 0927 90 SX T							
		77.030 0927 DX S							
		77.030 0927 DX T							
		77.030 0927 SX S							
		77.030 0927 SX T							
1000	2020 2100	90			77.030 1021 90 DX S			707,74	1
					77.030 1021 90 DX T				
					77.030 1021 90 SX S				
					77.030 1021 90 SX T				
					77.030 1021 DX S				
					77.030 1021 DX T				
	*2110 *2400	105			77.030 1021 SX S	812,59	1		
					77.030 1021 SX T				
					77.030 1024 90 DX S				
					77.030 1024 90 DX T				
					77.030 1024 90 SX S				
					77.030 1024 90 SX T				
	*2410 *2700	90	77.030 1024 DX S	969,88	1				
			77.030 1024 DX T						
			77.030 1024 SX S						
			77.030 1024 SX T						
			77.030 1027 90 DX S						
			77.030 1027 90 DX T						
*2410 *2700	105	77.030 1027 90 SX S	969,88					1	
		77.030 1027 90 SX T							
		77.030 1027 DX S							
		77.030 1027 DX T							
		77.030 1027 SX S							
		77.030 1027 SX T							

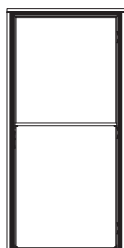

- Formado por: premarco soldado + Kubica K6200

Para medidas no Standard, se ruega preguntar la factibilidad de las mismas a Krona.

\*Medidas especiales



### Batiente Cartón-yeso



EGO es la nueva puerta batiente sin jambas ni tapajuntas, con un diseño puramente minimalista.

EGO es la única solución del mercado a ras de la pared que tiene un armazón compuesto de un único elemento!

La peculiaridad del modelo EGO con panel batiente es la presencia de la bisagra KUBICA "K6200" que permite regular la puerta en sus tres ejes.

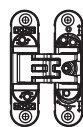
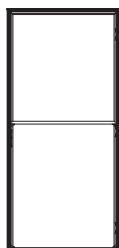

- Formado por: premarco soldado + Kubica K6200

Para medidas no Standard, se ruega preguntar la factibilidad de las mismas a Krona.

\*Medidas especiales

### EGO Batiente para cartón-yeso (premarco soldado + Kubica K6200)

ANCHO	ALTURA	espesor pared term.	CODIGO	€	Bultos			
600	2020	100	76.030 0621 100 DX S	642,21	1			
			76.030 0621 100 DX T					
			76.030 0621 100 SX S					
	2100	120	76.030 0621 100 SX T					
			76.030 0621 115 DX S					
			76.030 0621 115 DX T					
	*2110	100	76.030 0621 115 SX S			747,07	1	
			76.030 0621 115 SX T					
			76.030 0624 100 DX S					
		*2400	120	76.030 0624 100 DX T				
				76.030 0624 100 SX S				
				76.030 0624 100 SX T				
	*2410	100	76.030 0624 115 DX S	904,33	1			
			76.030 0624 115 DX T					
			76.030 0624 115 SX S					
		*2700	120					76.030 0624 115 SX T
								76.030 0627 100 DX S
								76.030 0627 100 DX T
700	2020	100	76.030 0721 100 DX S			642,21	1	
			76.030 0721 100 DX T					
			76.030 0721 100 SX S					
	2100	120	76.030 0721 100 SX T					
			76.030 0721 115 DX S					
			76.030 0721 115 DX T					
	*2110	100	76.030 0721 115 SX S	747,07	1			
			76.030 0721 115 SX T					
			76.030 0724 100 DX S					
		*2400	120			76.030 0724 100 DX T		
						76.030 0724 100 SX S		
						76.030 0724 100 SX T		
	*2410	100	76.030 0724 115 DX S			904,33	1	
			76.030 0724 115 DX T					
			76.030 0724 115 SX S					
		*2700	120					76.030 0724 115 SX T
								76.030 0727 100 DX S
								76.030 0727 100 DX T
800	2020	100	76.030 0821 100 DX S	642,21	1			
			76.030 0821 100 DX T					
			76.030 0821 100 SX S					
	2100	120	76.030 0821 100 SX T					
			76.030 0821 115 DX S					
			76.030 0821 115 DX T					
	*2110	100	76.030 0821 115 SX S			747,07	1	
			76.030 0821 115 SX T					
			76.030 0824 100 DX S					
		*2400	120	76.030 0824 100 DX T				
				76.030 0824 100 SX S				
				76.030 0824 100 SX T				
	*2410	100	76.030 0824 115 DX S	904,33	1			
			76.030 0824 115 DX T					
			76.030 0824 115 SX S					
		*2700	120					76.030 0824 115 SX T
								76.030 0827 100 DX S
								76.030 0827 100 DX T



### Batiente Cartón-yeso



EGO es la nueva puerta batiente sin jambas ni tapajuntas, con un diseño puramente minimalista.

EGO es la única solución del mercado a ras de la pared que tiene un armazón compuesto de un único elemento!

La peculiaridad del modelo EGO con panel batiente es la presencia de la bisagra KUBICA "K6200" que permite regular la puerta en sus tres ejes.



### EGO Batiente para cartón-yeso (premarco soldado + Kubica K6200)

ANCHO	ALTURA	espesor pared term.	CODIGO	€	Bultos					
900	2020	100	76.030 0921 100 DX S	642,21	1					
			76.030 0921 100 DX T							
			76.030 0921 100 SX S							
			76.030 0921 100 SX T							
			76.030 0921 115 DX S							
			76.030 0921 115 DX T							
	2100	120	76.030 0921 115 SX S							
			76.030 0921 115 SX T							
			76.030 0924 100 DX S							
			76.030 0924 100 DX T							
			76.030 0924 100 SX S							
			76.030 0924 100 SX T							
	*2110	100	76.030 0924 115 DX S			747,07	1			
			76.030 0924 115 DX T							
			76.030 0924 115 SX S							
			76.030 0924 115 SX T							
			*2400					120	76.030 0927 100 DX S	
									76.030 0927 100 DX T	
76.030 0927 100 SX S										
76.030 0927 100 SX T										
*2410	100	76.030 0927 115 DX S		904,33	1					
		76.030 0927 115 DX T								
		76.030 0927 115 SX S								
		76.030 0927 115 SX T								
		*2700	120					76.030 1021 100 DX S		
								76.030 1021 100 DX T		
76.030 1021 100 SX S										
76.030 1021 100 SX T										
2020	100							76.030 1021 115 DX S	707,74	1
								76.030 1021 115 DX T		
		76.030 1021 115 SX S								
		76.030 1021 115 SX T								
		2100	120			76.030 1024 100 DX S				
						76.030 1024 100 DX T				
76.030 1024 100 SX S										
76.030 1024 100 SX T										
*2110	100					76.030 1024 115 DX S	812,59	1		
						76.030 1024 115 DX T				
		76.030 1024 115 SX S								
		76.030 1024 115 SX T								
		*2400	120	76.030 1027 100 DX S						
				76.030 1027 100 DX T						
76.030 1027 100 SX S										
76.030 1027 100 SX T										
*2410	100			76.030 1027 115 DX S	969,88	1				
				76.030 1027 115 DX T						
		76.030 1027 115 SX S								
		76.030 1027 115 SX T								
		*2700	120	76.030 1027 115 DX S						
				76.030 1027 115 DX T						
76.030 1027 115 SX S										
76.030 1027 115 SX T										

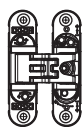
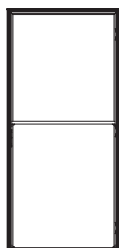

- Formado por: premarco soldado + Kubica K6200

Para medidas no Standard, se ruega preguntar la factibilidad de las mismas a Krona.

\*Medidas especiales

# EGO

## PREMARCO + PANEL PUERTA

### Batiente Revoque



EGO es la nueva puerta batiente sin jambas ni tapajuntas, con un diseño puramente minimalista. EGO es la única solución del mercado a ras de la pared que tiene un armazón compuesto de un único elemento! La peculiaridad del modelo EGO con panel batiente es la presencia de la bisagra KUBICA "K6200" que permite regular la puerta en sus tres ejes.



- Formado por: premarco soldado + puerta + Kubica K6200

Para medidas no Standard, se ruega preguntar la factibilidad de las mismas a Krona.

### EGO Batiente perfil único para revoque (premarco soldado + puerta + Kubica K6200)

ANCHO	ALTURA	espesor pared term.	CODIGO	€	Bultos		
600	2020 2100	90	777.0300621 90 DX S	904,33	2		
			777.0300621 90 DX T				
			777.0300621 90 SX S				
			777.0300621 90 SX T				
			777.0300621 DX S				
			777.0300621 DX T				
	*2110 *2400	105	777.0300621 SX S				
			777.0300621 SX T				
			777.0300624 90 DX S				
			777.0300624 90 DX T				
			777.0300624 90 SX S				
			777.0300624 90 SX T				
	*2410 *2700	90	777.0300624 DX S			1.114,05	
			777.0300624 DX T				
			777.0300624 SX S				
			777.0300624 SX T				
			777.0300627 90 DX S				
			777.0300627 90 DX T				
*2410 *2700	105	777.0300627 90 SX S	1.140,27				
		777.0300627 90 SX T					
		777.0300627 DX S					
		777.0300627 DX T					
		777.0300627 SX S					
		777.0300627 SX T					
700	2020 2100	90		777.0300721 90 DX S	904,33		2
				777.0300721 90 DX T			
				777.0300721 90 SX S			
				777.0300721 90 SX T			
				777.0300721 DX S			
				777.0300721 DX T			
	*2110 *2400	105		777.0300721 SX S		1.114,05	
				777.0300721 SX T			
				777.0300724 90 DX S			
				777.0300724 90 DX T			
				777.0300724 90 SX S			
				777.0300724 90 SX T			
	*2410 *2700	90	777.0300724 DX S	1.140,27			
			777.0300724 DX T				
			777.0300724 SX S				
			777.0300724 SX T				
			777.0300727 90 DX S				
			777.0300727 90 DX T				
*2410 *2700	105	777.0300727 90 SX S	1.140,27				
		777.0300727 90 SX T					
		777.0300727 DX S					
		777.0300727 DX T					
		777.0300727 SX S					
		777.0300727 SX T					
800	2020 2100	90			777.0300821 90 DX S	904,33	2
					777.0300821 90 DX T		
					777.0300821 90 SX S		
					777.0300821 90 SX T		
					777.0300821 DX S		
					777.0300821 DX T		
	*2110 *2400	105		777.0300821 SX S	1.114,05		
				777.0300821 SX T			
				777.0300824 90 DX S			
				777.0300824 90 DX T			
				777.0300824 90 SX S			
				777.0300824 90 SX T			
	*2410 *2700	90	777.0300824 DX S	1.140,27			
			777.0300824 DX T				
			777.0300824 SX S				
			777.0300824 SX T				
			777.0300827 90 DX S				
			777.0300827 90 DX T				
*2410 *2700	105	777.0300827 90 SX S	1.140,27				
		777.0300827 90 SX T					
		777.0300827 DX S					
		777.0300827 DX T					
		777.0300827 SX S					
		777.0300827 SX T					

\*Medidas especiales

# EGO

## PREMARCO + PANEL PUERTA

### Batiente Revoque



EGO es la nueva puerta batiente sin jambas ni tapajuntas, con un diseño puramente minimalista. EGO es la única solución del mercado a ras de la pared que tiene un armazón compuesto de un único elemento! La peculiaridad del modelo EGO con panel batiente es la presencia de la bisagra KUBICA "K6200" que permite regular la puerta en sus tres ejes.



- Formado por: premarco soldado + puerta + Kubica K6200

Para medidas no Standard, se ruega preguntar la factibilidad de las mismas a Krona.

\*Medidas especiales

### EGO Batiente perfil único para revoque (premarco soldado + puerta + Kubica K6200)

ANCHO	ALTURA	espesor pared term.	CODIGO	€	Bultos		
900	2020 2100	90	777.0300921 90 DX S	904,33	2		
			777.0300921 90 DX T				
			777.0300921 90 SX S				
			777.0300921 90 SX T				
			777.0300921 DX S				
			777.0300921 DX T				
	*2110 *2400	105	777.0300921 SX S				
			777.0300921 SX T				
			777.0300924 90 DX S				
			777.0300924 90 DX T				
			777.0300924 90 SX S				
			777.0300924 90 SX T				
	*2410 *2700	90	777.0300924 DX S			1.114,05	2
			777.0300924 DX T				
			777.0300924 SX S				
			777.0300924 SX T				
			777.0300927 90 DX S				
			777.0300927 90 DX T				
*2410 *2700	105	777.0300927 90 SX S					
		777.0300927 90 SX T					
		777.0300927 DX S					
		777.0300927 DX T					
		777.0300927 SX S					
		777.0300927 SX T					
1000	2020 2100	90	777.0301021 90 DX S	996,09	2		
			777.0301021 90 DX T				
			777.0301021 90 SX S				
			777.0301021 90 SX T				
			777.0301021 DX S				
			777.0301021 DX T				
	*2110 *2400	105	777.0301021 SX S				
			777.0301021 SX T				
			777.0301024 90 DX S				
			777.0301024 90 DX T				
			777.0301024 90 SX S				
			777.0301024 90 SX T				
	*2410 *2700	90	777.0301024 DX S			1.226,77	2
			777.0301024 DX T				
			777.0301024 SX S				
			777.0301024 SX T				
			777.0301027 90 DX S				
			777.0301027 90 DX T				
*2410 *2700	105	777.0301027 90 SX S					
		777.0301027 90 SX T					
		777.0301027 DX S					
		777.0301027 DX T					
		777.0301027 SX S					
		777.0301027 SX T					
			777.0301027 SX T	1.255,59	2		

### Batiente Cartón-yeso



EGO es la nueva puerta batiente sin jambas ni tapajuntas, con un diseño puramente minimalista.

EGO es la única solución del mercado a ras de la pared que tiene un armazón compuesto de un único elemento!

La peculiaridad del modelo EGO con panel batiente es la presencia de la bisagra KUBICA "K6200" que permite regular la puerta en sus tres ejes.

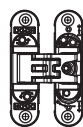

- Formado por: premarco soldado + puerta + Kubica K6200

Para medidas no Standard, se ruega preguntar la factibilidad de las mismas a Krona.

### EGO Batiente para cartón-yeso (premarco soldado + puerta + Kubica K6200)

ANCHO	ALTURA	espesor pared term.	CODIGO	€	Bultos						
600	2020 2100	100	776.0300621 100 DX S	904,33	2						
			776.0300621 100 DX T								
			776.0300621 100 SX S								
			776.0300621 100 SX T								
			776.0300621 115 DX S								
			776.0300621 115 DX T								
	*2110 *2400	120	776.0300621 115 SX S								
			776.0300621 115 SX T								
			776.0300624 100 DX S								
			776.0300624 100 DX T								
			776.0300624 100 SX S								
			776.0300624 100 SX T								
	*2410 *2700	100	776.0300624 115 DX S			1.114,05	2				
			776.0300624 115 DX T								
			776.0300624 115 SX S								
			776.0300624 115 SX T								
			*2410 *2700					120	776.0300627 100 DX S		
									776.0300627 100 DX T		
776.0300627 100 SX S											
776.0300627 100 SX T											
776.0300627 115 DX S											
776.0300627 115 DX T											
700	2020 2100	100	776.0300721 100 DX S	904,33	2						
			776.0300721 100 DX T								
			776.0300721 100 SX S								
			776.0300721 100 SX T								
			776.0300721 115 DX S								
			776.0300721 115 DX T								
	*2110 *2400	120	776.0300721 115 SX S					1.114,05	2		
			776.0300721 115 SX T								
			776.0300724 100 DX S								
			776.0300724 100 DX T								
			776.0300724 100 SX S								
			776.0300724 100 SX T								
	*2410 *2700	100	776.0300724 115 DX S			1.140,27	2				
			776.0300724 115 DX T								
			776.0300724 115 SX S								
			776.0300724 115 SX T								
			*2410 *2700							120	776.0300727 100 DX S
											776.0300727 100 DX T
776.0300727 100 SX S											
776.0300727 100 SX T											
776.0300727 115 DX S											
776.0300727 115 DX T											
800	2020 2100	100	776.0300821 100 DX S	904,33	2						
			776.0300821 100 DX T								
			776.0300821 100 SX S								
			776.0300821 100 SX T								
			776.0300821 115 DX S								
			776.0300821 115 DX T								
	*2110 *2400	120	776.0300821 115 SX S					1.114,05	2		
			776.0300821 115 SX T								
			776.0300824 100 DX S								
			776.0300824 100 DX T								
			776.0300824 100 SX S								
			776.0300824 100 SX T								
	*2410 *2700	100	776.0300824 115 DX S			1.140,27	2				
			776.0300824 115 DX T								
			776.0300824 115 SX S								
			776.0300824 115 SX T								
			*2410 *2700							120	776.0300827 100 DX S
											776.0300827 100 DX T
776.0300827 100 SX S											
776.0300827 100 SX T											
776.0300827 115 DX S											
776.0300827 115 DX T											

\*Medidas especiales

# EGO

## PREMARCO + PANEL PUERTA

### Batiente Cartón-yeso



EGO es la nueva puerta batiente sin jambas ni tapajuntas, con un diseño puramente minimalista.

EGO es la única solución del mercado a ras de la pared que tiene un armazón compuesto de un único elemento!

La peculiaridad del modelo EGO con panel batiente es la presencia de la bisagra KUBICA "K6200" que permite regular la puerta en sus tres ejes.



### EGO Batiente para cartón-yeso (premarco soldado + puerta + Kubica K6200)

ANCHO	ALTURA	espesor pared term.	CODIGO	€	Bultos			
900	2020	100	776.0300921 100 DX S	904,33	2			
			776.0300921 100 DX T					
			776.0300921 100 SX S					
	2100	120	776.0300921 100 SX T					
			776.0300921 115 DX S					
			776.0300921 115 DX T					
	*2110	100	776.0300921 115 SX S			1.114,05	2	
			776.0300921 115 SX T					
			776.0300924 100 DX S					
		*2400	120	776.0300924 100 DX T				
				776.0300924 100 SX S				
				776.0300924 100 SX T				
	*2410	100	776.0300924 115 DX S	1.140,27	2			
			776.0300924 115 DX T					
			776.0300924 115 SX S					
		*2700	120					776.0300924 115 SX T
								776.0300927 100 DX S
								776.0300927 100 DX T
1000	2020	100	776.0301021 100 DX S			996,09	2	
			776.0301021 100 DX T					
			776.0301021 100 SX S					
	2100	120	776.0301021 100 SX T					
			776.0301021 115 DX S					
			776.0301021 115 DX T					
	*2110	100	776.0301021 115 SX S	1.226,77	2			
			776.0301021 115 SX T					
			776.0301024 100 DX S					
		*2400	120			776.0301024 100 DX T		
						776.0301024 100 SX S		
						776.0301024 100 SX T		
	*2410	100	776.0301024 115 DX S			1.255,59	2	
			776.0301024 115 DX T					
			776.0301024 115 SX S					
		*2700	120					776.0301024 115 SX T
								776.0301027 100 DX S
								776.0301027 100 DX T
*2700	100	776.0301027 100 SX S						
		776.0301027 100 SX T						
		776.0301027 115 DX S						
	120	776.0301027 115 DX T						
		776.0301027 115 SX S						
		776.0301027 115 SX T						

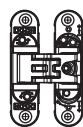

- Formado por: premarco soldado + puerta + Kubica K6200

Para medidas no Standard, se ruega preguntar la factibilidad de las mismas a Krona.

\*Medidas especiales

### TRATAMIENTO

Descripción artículo	CODIGO	€	Bultos
CEMENTITE	7.C	133,68	-



Para medidas no Standard, se ruega preguntar la factibilidad de las mismas a Krona.

**Notas:**

- Para modelo "Altura total" (1500-2400) el precio es el mismo que el de 2400.
- Para modelo "Altura total" (2410-2700) el precio es el mismo que el de 2700.
- Incremento por medidas de anchura intermedia +10%.
- Incremento por medidas entre 1500 y 2000 +10% en altura.
- Para alturas superiores a 2700, pedir factibilidad y presupuesto a Krona.

### CERRADURAS

Descripción artículo	CODIGO	€	Bultos
Bonaiti Magnética B.ONE992 cajeado manilla + cerradura	M.EGO B 02	40,10	1
Bonaiti Magnética B.ONE S909 "YALE"	M.EGO B 03	37,10	1
Bonaiti Magnética B.ONE992 patent.	M.EGO B 04	37,33	1

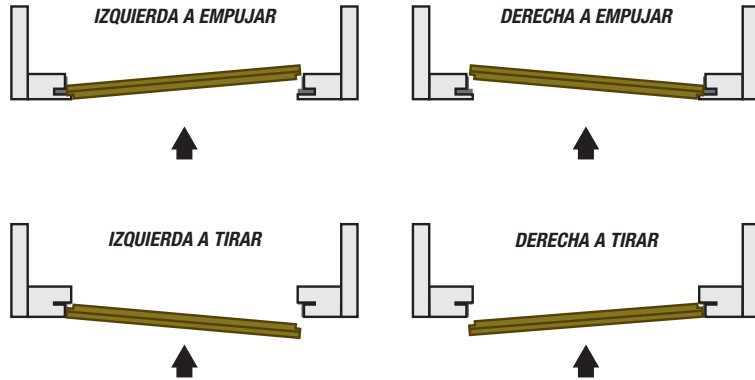



- Diseño innovador.
- Nueva estructura soldada.
- Bisagra KubiKuadra que permite instalar una puerta convencional solapada en un marco a filo pared.

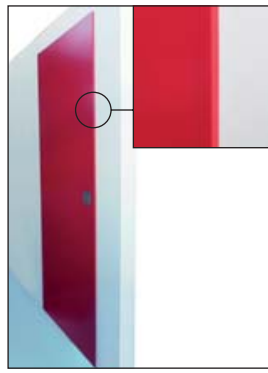

**Notas:**

- Para medidas diferentes, consultar Krona Koblenz.
- Formado por: premarco soldado + KubiKuadra.

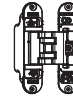

## PREMARCO

### EGO KUADRO para revoque

ANCHO	ALTURA	espesor pared term.	CODIGO	€	Bultos
700	2000/2100	105	87.030 0721 DX T	<b>674,92</b>	1
			87.030 0721 SX T		
	2110-2400	105	87.030 0724 DX T	<b>802,17</b>	1
			87.030 0724 SX T		
	2410-2700	105	87.030 0727 DX T	<b>904,22</b>	1
			87.030 0727 SX T		
800	2000/2100	105	87.030 0821 DX T	<b>674,92</b>	1
			87.030 0821 SX T		
	2110-2400	105	87.030 0824 DX T	<b>802,17</b>	1
			87.030 0824 SX T		
	2410-2700	105	87.030 0827 DX T	<b>904,22</b>	1
			87.030 0827 SX T		
900	2000/2100	105	87.030 0921 DX T	<b>674,92</b>	1
			87.030 0921 SX T		
	2110-2400	105	87.030 0924 DX T	<b>802,17</b>	1
			87.030 0924 SX T		
	2410-2700	105	87.030 0927 DX T	<b>904,22</b>	1
			87.030 0927 SX T		





- Diseño innovador.
- Nueva estructura soldada.
- Bisagra KubiKuadra que permite instalar una puerta convencional solapada en un marco a filo pared.

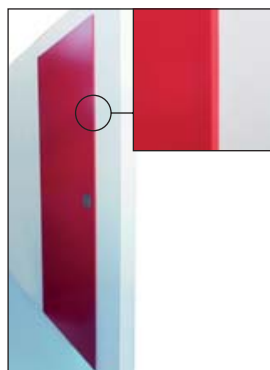

**Notas:**

- Para medidas diferentes, consultar Krona Koblenz.
- Formado por: premarco soldado + KubiKuadra

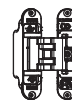

## PREMARCO

### EGO KUADRO para cartón-yeso

ANCHO	ALTURA	espesor pared term.	CODIGO	€	Bultos
700	2000/2100	100	86.030 0721 100 DX T	<b>674,92</b>	1
			86.030 0721 100 SX T		
	2110-2400	100	86.030 0724 100 DX T	<b>802,17</b>	1
			86.030 0724 100 SX T		
	2410-2700	100	86.030 0727 100 DX T	<b>904,22</b>	1
			86.030 0727 100 SX T		
800	2000/2100	100	86.030 0821 100 DX T	<b>674,92</b>	1
			86.030 0821 100 SX T		
	2110-2400	100	86.030 0824 100 DX T	<b>802,17</b>	1
			86.030 0824 100 SX T		
	2410-2700	100	86.030 0827 100 DX T	<b>904,22</b>	1
			86.030 0827 100 SX T		
900	2000/2100	100	86.030 0921 100 DX T	<b>674,92</b>	1
			86.030 0921 100 SX T		
	2110-2400	100	86.030 0924 100 DX T	<b>802,17</b>	1
			86.030 0924 100 SX T		
	2410-2700	100	86.030 0927 100 DX T	<b>904,22</b>	1
			86.030 0927 100 SX T		

### EGO KUADRO panel puerta

ANCHO	ALTURA	espesor puerta	CODIGO	€	Bultos
734	2115	45	7787 030 0721	<b>254,72</b>	1
834	2115	45	7787 030 0821	<b>254,72</b>	1
934	2115	45	7787 030 0921	<b>254,72</b>	1



- Solución a filo pared con ABS con apertura por ambos lados.
- Nuevo perfil tubular: para garantizar la solidez de la estructura.
- Película protectora en la superficie: para un acabado perfecto.
- ABS de serie, evita accidentes, invisible, 70kg patentado.
- Fácil instalación: gracias al sistema patentado de acoplamiento/desenganche de la hoja.
- Regulable sin desmontar la puerta.
- Movimiento fluido: gracias al diseño especial del carro de 4 ruedas con cojinetes.



**Notas:**

- Para medidas diferentes, consultar Krona Koblenz.
- Formado por: premarco soldado.
- Paneles ya mecanizados, cerradura (o cierre) según la descripción del cliente.

## PREMARCO

### EGO SwingLife para revoque

Lup Lp-37 (Sp=40)	Hup Hp+17	Lvm Lp+140	Hvm Hp+81	Lp	Hp	espesor pared term.	CODIGO	€	Bultos
728	2001	905	2065	765	1984	105	81 765 1984 105 DX 81 765 1984 105 SX	<b>917,98</b>	1
	2051	905	2115	765	2034	105	81 765 2034 105 DX 81 765 2034 105 SX	<b>917,98</b>	1
	2101	905	2165	765	2084	105	81 765 2084 105 DX 81 765 2084 105 SX	<b>917,98</b>	1
828	2001	1005	2065	865	1984	105	81 865 1984 105 DX 81 865 1984 105 SX	<b>917,98</b>	1
	2051	1005	2115	865	2034	105	81 865 2034 105 DX 81 865 2034 105 SX	<b>917,98</b>	1
	2101	1005	2165	865	2084	105	81 865 2084 105 DX 81 865 2084 105 SX	<b>917,98</b>	1
928	2001	1105	2065	965	1984	105	81 965 1984 105 DX 81 965 1984 105 SX	<b>917,98</b>	1
	2051	1105	2115	965	2034	105	81 965 2034 105 DX 81 965 2034 105 SX	<b>917,98</b>	1
	2101	1105	2165	965	2084	105	81 965 2084 105 DX 81 965 2084 105 SX	<b>917,98</b>	1

### HOJA SIN BATIENTE

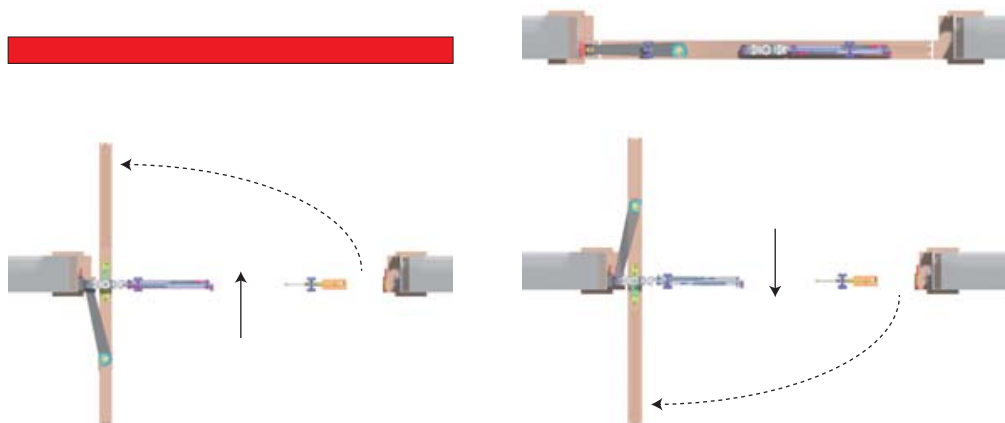

# EGO

# SwingLife

PAT-PENDING

## Cartón-yeso

## ABS



- Solución a filo pared con ABS con apertura por ambos lados.
- Nuevo perfil tubular: para garantizar la solidez de la estructura.
- Película protectora en la superficie: para un acabado perfecto.
- ABS de serie, evita accidentes, invisible, 70kg patentado.
- Fácil instalación: gracias al sistema patentado de acoplamiento/desenganche de la hoja.
- Regulable sin desmontar la puerta.
- Movimiento fluido: gracias al diseño especial del carro de 4 ruedas con cojinetes.



Notas:

- Para medidas diferentes, consultar Krona Koblenz.
- Formado por: premarco soldado.
- Paneles ya mecanizados, cerradura (o cierre) según la descripción del cliente.

## PREMARCO

### EGO SwingLife para cartón-yeso

Lup Lp-37 (Sp=40)	Hup Hp+17	Lvm Lp+140	Hvm Hp+81	Lp	Hp	espesor pared term.	CODIGO	€	Bultos
728	2001	905	2065	765	1984	100	80 765 1984 100 DX	<b>917,98</b>	1
							80 765 1984 100 SX		
	2051	905	2115	765	2034	100	80 765 2034 100 DX	<b>917,98</b>	1
							80 765 2034 100 SX		
	2101	905	2165	765	2084	100	80 765 2084 100 DX	<b>917,98</b>	1
							80 765 2084 100 SX		
828	2001	1005	2065	865	1984	100	80 865 1984 100 DX	<b>917,98</b>	1
							80 865 1984 100 SX		
	2051	1005	2115	865	2034	100	80 865 2034 100 DX	<b>917,98</b>	1
							80 865 2034 100 SX		
	2101	1005	2165	865	2084	100	80 865 2084 100 DX	<b>917,98</b>	1
							80 865 2084 100 SX		
928	2001	1105	2065	965	1984	100	80 965 1984 100 DX	<b>917,98</b>	1
							80 965 1984 100 SX		
	2051	1105	2115	965	2034	100	80 965 2034 100 DX	<b>917,98</b>	1
							80 965 2034 100 SX		
	2101	1105	2165	965	2084	100	80 965 2084 100 DX	<b>917,98</b>	1
							80 965 2084 100 SX		

### EGO SwingLife panel puerta

ANCHO	ALTURA	espesor puerta	CODIGO	€	Bultos
765	2084	40	7780 030 0720	<b>329,89</b>	1
865	2084	40	7780 030 0820	<b>329,89</b>	1
965	2084	40	7780 030 0920	<b>329,89</b>	1

### EGO SwingLife accesorios

Descripción	CODIGO	€	Bultos
Cepillo para polvo blanco	9700 6 B	<b>7,20</b>	1
Cepillo para polvo negro	9700 6 N	<b>7,20</b>	
Goma de choque gris	9700 8 G	<b>5,06</b>	
Goma de choque negro	9700 8 N	<b>5,06</b>	

## ACCESORIOS de deslizamiento para armazón

Descripción	CODIGO	€	Paquete mín.
<b>Kit carros</b>			
Kit accesorios Krona 50/80 Kg.	0501 KROS	53,76	1
Kit carros kg 80, Kit Futura	0500 80	58,81	1
Kit accesorios Krona 50/80 Kg. Kompatto	9002	28,24	1
<b>Kit ABS</b>			
Kit ABS + carros 50 Kg.	0500 51 12 1ABS	43,26	1
Kit acc. puerta corredera 80 Kg. + ABS	0500 80 0860	111,32	1
Kit de cierre ABS EGO + Pletinas 0600	0600 80 0860	151,86	1
Kit ABS 50/80 Kg.	0840 1	34,88	1
Kit de cierre ABS 40 Kg.	0860 1	23,26	10
Kit de cierre ABS 80 Kg.	0860 80	37,20	10
Activador ABS	0860 2	3,49	1
Pletina de frenado ABS	0860 5	3,49	1
Soporte para pletina de frenado en "T" ABS	0860 6	3,49	1
ABS 40 Kg.	0860 7	20,30	1
ABS 80 Kg.	0860 8	34,36	1
<b>Kit vidrio</b>			
Kit 1730 / mm 880	1730 880	121,69	1
Kit 1730 / mm 1280	1730 1280	134,92	1
<b>Kit madera</b>			
Kit apertura simultanea, para hoja doble	0550 KRO.	61,27	1
Kit hojas paralelas	2000	18,77	1
<b>Gomas de choque y cepillos</b>			
Goma de choque negro para jambas, mt 1	1702 NERO	1,19	1
Goma de choque gris para EGO batiente, mt 1	1706 GRIGIO	2,56	1
Cepillo para polvo negro, mm 2100x13	1801	5,94	1

**Notas:**

- El kit de apertura sincronizada para hoja doble (cód. 0550 KRO.) se ha de pedir juntamente con el armazón de hoja doble.

\*Disponibile hasta agotamiento stock.

**MÓDULO DE PEDIDO ARMAZONES PARA INTERIOR**



**KRONA - KOBLENZ** s.l.

PI.MOLI'DEN XEC

NAVE n P3-3/6...c/ Mollí d' en Xec, n 49/55 C.P.08291

Ripollt - (Barcelona) - ESPAÑA

Tel: +34 93 591 0410 - Fax: +34 93 591 0498

www.kronakoblenz.com - info@kronakoblenz.es

<b>DISTRIBUIDOR</b>	<b>AGENTE</b>	<b>FECHA PEDIDO</b>	<b>REF. CLIENTE</b>
	<b>LUGAR DE ENTREGA</b>		

<b>EL MÓDULO DEBE ESTAR COMPLETO Y FIRMADO</b>								
CANTIDAD	COD. ARTÍCULO	MOD. ARMAZÓN	TIPOLOGIA ARMAZÓN (marcarcon una x)		LUZ DE PASO		ESPOSOR PARED ACABADA mm	
			hoja única	hoja doble	anchura mm	altura mm	revoque mm	cartón-yeso mm

**NOTAS:**

**SELLO Y FIRMA DEL DISTRIBUIDOR**

# Cómo pedir EGO BATIENTE

Cliente \_\_\_\_\_

Tel. \_\_\_\_\_

Fax \_\_\_\_\_ E-mail \_\_\_\_\_

Lup:  600  700  800  900

Hup:  2000  2100  2020

FM: Lup \_\_\_\_\_ x Hup \_\_\_\_\_

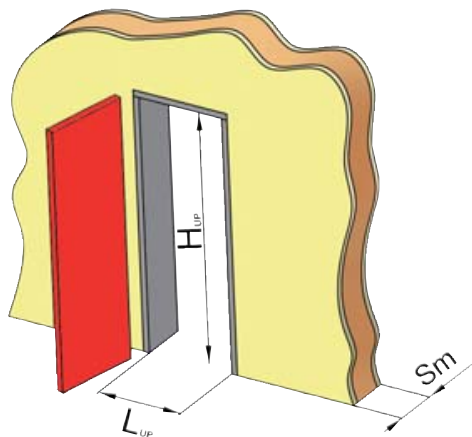

Lvm \_\_\_\_\_ x Hvm \_\_\_\_\_

Lp \_\_\_\_\_ x Hp \_\_\_\_\_

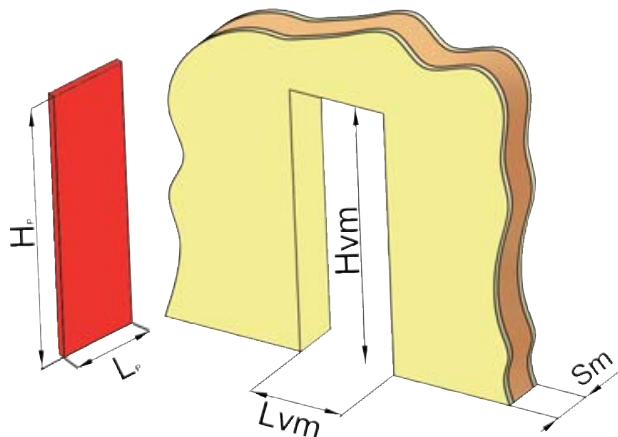

Espesor pared:

Cartón-yeso  100  100  120  125

(España)

(España)

Revoque  90  105  \_\_\_\_\_

Abertura panel:

DER  Empujar  Marco  
 IZQ  Tirar  Marco+Panel

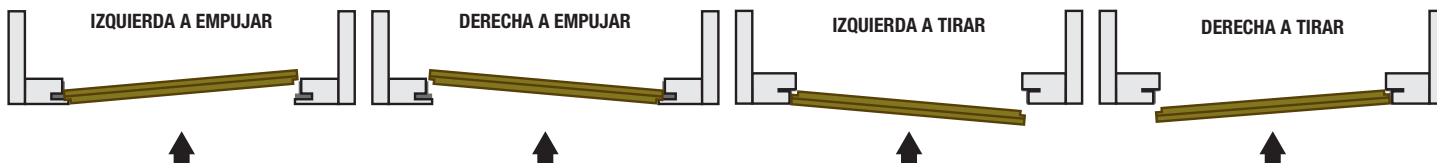

Espesor panel: \_\_\_\_\_ mm.

Peso panel: \_\_\_\_\_ kg.

Cementite

Mecanizado manillas / Cerraduras:

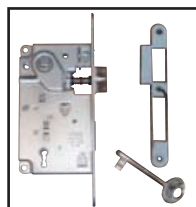

AGB CENTRO  
 AGB POLARIS  
 AGB MEDIANA EVOLUTION

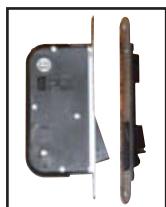

BONAITI B-ONE  
 BONAITI B-TWO  
 BONAITI B-FORTY

7.17 SÓLO MANILLA

7.18 CAJEADO MANILLA + CERRADURA

7.25 MECANIZADO YALE

7.26 MECANIZADO PATENT

Para pedidos superiores a 50 uds, es posible variar la elección de los tiradores/cerraduras, previo estudio de factibilidad por parte de Krona-Koblenz sl.

ATENCIÓN: las ilustraciones y los dibujos técnicos podrán sufrir, sin previo aviso, leves variaciones. Por lo tanto, si a nuestro criterio, la estética y la calidad del producto permanecen inalterables, el cliente no podrá rescindir de nuestro contrato, ni tendrá derecho a descuentos particulares.

# Cómo pedir EGO KUADRO

Cliente \_\_\_\_\_

Tel. \_\_\_\_\_

Fax \_\_\_\_\_ E-mail \_\_\_\_\_

Lup:  700  800  900

Hup:  2000  2100

FM: Lup \_\_\_\_\_ x Hup \_\_\_\_\_

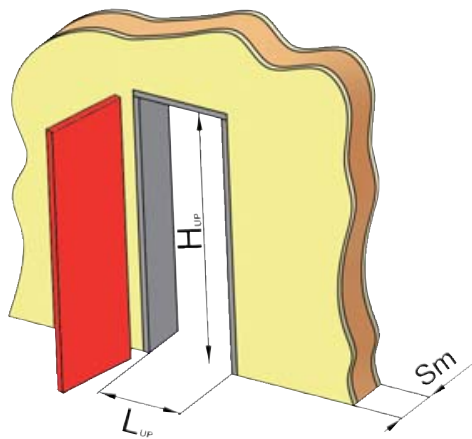

Lvm \_\_\_\_\_ x Hvm \_\_\_\_\_

Lp \_\_\_\_\_ x Hp \_\_\_\_\_

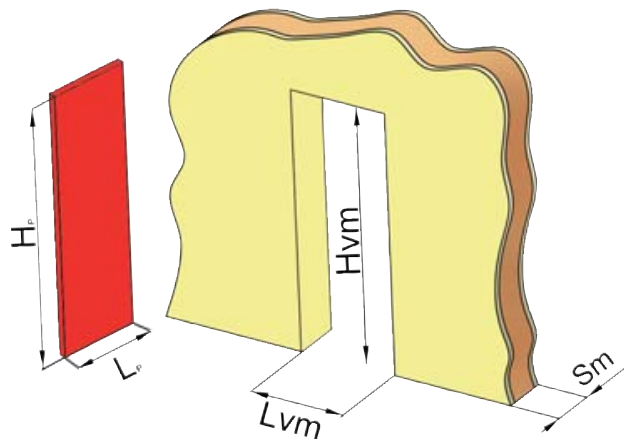

Cartón-yeso  100

Esesor pared:

Revoque  105

Abertura panel:

DER

Marco

IZQ

Marco+Panel



Esesor panel: \_\_\_\_\_ mm.

Peso panel: \_\_\_\_\_ kg.

Cementite

Mecanizado manillas / Cerraduras:

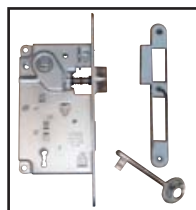

AGB  
CENTRO

AGB  
POLARIS

AGB  
MEDIANA  
EVOLUTION

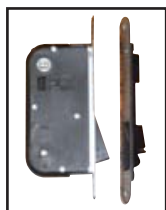

BONAITI  
B-ONE

BONAITI  
B-TWO

BONAITI  
B-FORTY

7.17  
SÓLO MANILLA

7.18  
CAJEADO MANILLA  
+ CERRADURA

7.25  
MECANIZADO YALE

7.26  
MECANIZADO PATENT

Para pedidos superiores a 50 uds, es posible variar la elección de los tiradores/cerraduras, previo estudio de factibilidad por parte de Krona-Koblenz sl.

ATENCIÓN: las ilustraciones y los dibujos técnicos podrán sufrir, sin previo aviso, leves variaciones. Por lo tanto, si a nuestro criterio, la estética y la calidad del producto permanecen inalterables, el cliente no podrá rescindir de nuestro contrato, ni tendrá derecho a descuentos particulares.



# Cómo pedir EGO SWINGLIFE

Cliente \_\_\_\_\_

Tel. \_\_\_\_\_

Fax \_\_\_\_\_ E-mail \_\_\_\_\_

Lp:  765  865  965

Hp:  1984  2034  2084

FM: Lp \_\_\_\_\_ x Hp \_\_\_\_\_

Lvm \_\_\_\_\_ x Hvm \_\_\_\_\_

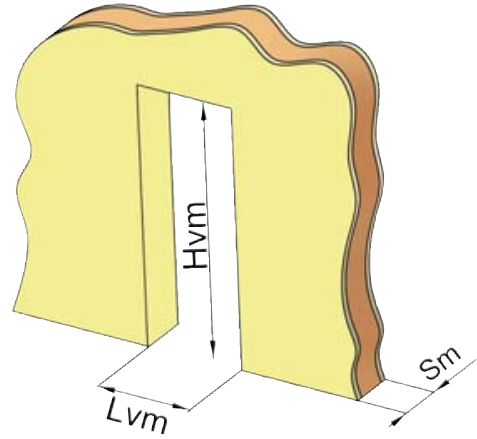
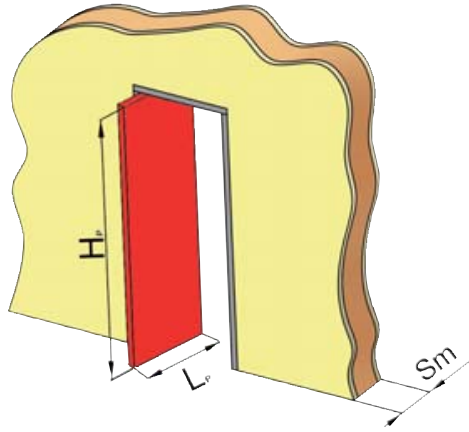

Cartón-yeso  100

Espesor pared:

Revoque  105

Abertura panel:

DER

Marco

IZQ

Marco+Panel

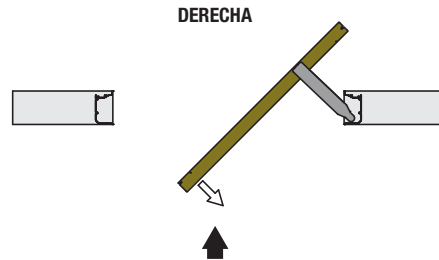
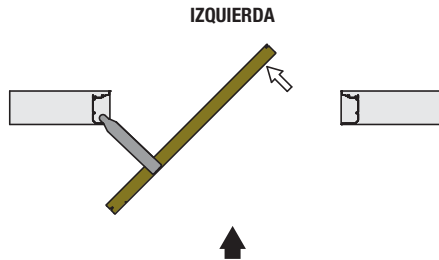

Espesor panel: \_\_\_\_\_ mm.

Peso panel: \_\_\_\_\_ kg.

Cementite

Mecanizado manillas / Cerraduras:



BONAITI  
B-ONE

7.17  
SÓLO MANILLA

7.18  
CAJEADO MANILLA  
+ CERRADURA

7.25  
MECANIZADO YALE

7.26  
MECANIZADO PATENT

Para pedidos superiores a 50 uds, es posible variar la elección de los tiradores/cerraduras, previo estudio de factibilidad por parte de Krona-Koblenz sl.

ATENCIÓN: las ilustraciones y los dibujos técnicos podrán sufrir, sin previo aviso, leves variaciones. Por lo tanto, si a nuestro criterio, la estética y la cualidad del producto permanecen inalterables, el cliente no podrá rescindir de nuestro contrato, ni tendrá derecho a descuentos particulares.

# CONDICIONES GENERALES DE VENTA

## **Vigencia**

Los precios de esta tarifa entraran en vigor a partir del 1 octubre 2021.

Los pedidos deberán enviarse por fax al número 93.591 0498 o por correo electrónico a pedidos@kronakoblenz.es.

NO SE ACEPTAN PEDIDOS TELEFONICAMENTE.

## **Pedidos Krona**

En el pedido se deberá especificar el código del artículo, descripción, altura, anchura y espesor de la pared acabada, así como la madera de las jambas y todas las informaciones suplementares, de manera legible y clara. En caso de medidas especiales rogamos especificar también anchura y altura del hueco pared.

ATENCIÓN: para medidas especiales en altura y en anchura se recomienda un espesor pared de min.105/120.

Se recomienda el utilizo de los módulos presentes en este listado para enviar correctamente los pedidos.

Transportes Krona: véase el inserto

## **Pedidos Krona**

En el pedido se deberá especificar el código del artículo y su descripción de manera legible y clara.

No se aceptan pedidos que no respeten las cantidades mínimas de embalaje reflejadas en el listado koblenz vigente.

## **Reclamaciones en la entrega**

En caso de verificar una incidencia en la mercancía, se deberá indicar en presencia del transportista, el problema en la documentación de transporte, aceptar la mercancía y enviar un FAX del documento a KRONA KOBLENZ SL, dentro las 24 horas (93 591 0498). Esto garantizará una rápida identificación de las causas y de las responsabilidades, y al mismo tiempo una eficaz resolución del problema.

Si al contrario la incidencia se encuentra solamente después de recibir el material, enviar la reclamación a la Oficina Comercial KRONA KOBLENZ.

## **Devoluciones**

Se aceptan las devoluciones solo si están autorizadas por la Oficina Comercial KRONA KOBLENZ.

Si esta devolución resulta ser imputable al Cliente, como norma se aplica un coste que varía en relación a la tipología del producto y a su estado de conservación.

Para los productos especiales no se aceptan las devoluciones.

## **Cancelación del pedido**

Para los productos de stock (aquellos con fecha de expedición en tres días laborables) es posible cancelar el pedido sin costes dentro del mismo día de envío.

Para los productos especiales que prevén tiempos de expedición mayores de 3 días, se acepta la cancelación dentro de 24 horas desde la fecha de confirmación del pedido.

## **Pagos**

El cliente realizará el pago en el momento y en la forma pactada. De todas formas solo se aceptará un fecha para el pago. Los retrasos generan la suspensión en el envío de cualquier material pendiente hasta la regulación del pago. Tal retraso implicará el cargo de los intereses comerciales al interés bancario aumentado del 2% más los costes anexos.

## **Iva**

Los precios indicados no incluyen iva

## **Jurisdicción**

Para las cuestiones que puedan plantearse, el comprador se somete expresamente a los juzgados y tribunales de Barcelona, con renuncia a su jurisdicción.

## **Medidas**

Las medidas están expresadas en milímetros

Los precios y las condiciones presentes en este catálogo son validos salvo si hay errores tipográficos.

Nota: para armazones de ancho comprendido entre 1300 y 1800, es necesaria una confirmación de pedido firmada por el cliente, juntamente con el exonerador de responsabilidad de Krona.

## KRONA precios de transporte para armazones para revoque y cartón-yeso

- Las piezas sueltas, independientemente del número de palets pedidos, siguen siempre la base de cálculo de la tabla A y no van a portes pagados.
- El embalaje en palets sólo se puede realizar con armazones de medidas Standard (L=600-1000, H max=2100).
- Los armazones fuera medida no se pueden paletizar, por tanto su transporte se ha de calcular siguiendo siempre la tabla A.

	Península	Baleares	Canarias
	€/ palet	€/ palet	€/ palet
mayores o iguales 3 palet	PORTE PAGADO	60 (€ por palet)	80 (€ por palet)
2 palet	50 (€ por palet)	100 (€ por palet)	150 (€ por palet)
1 palet	70 (€ por palet)	120 (€ por palet)	200 (€ por palet)
piezas sueltas, independientemente del número de palets.	VÉASE TABLA A	VÉASE TABLA A	VÉASE TABLA A

Ej: La compra de 14 armazones Krona en Catalunya corresponde a 1 palet + 5 piezas sueltas

El coste del transporte será: (nº palet \*coste palet) + (nº piezas sueltas \*coste del transporte de tabla)

1 palet 70 €

5 piezas 12 € \* 5 = 60 €

total expedición 130 €

Notas: Krona 10 armazones estandar hoja única por palet  
Kompatto 10 armazones estandar hoja única por palet  
Kit futura 10 armazones estandar hoja única por palet  
Hoja doble corresponde a nº 2 armazones estandar hoja única

## KRONA tabla precios transporte para material suelto

## TABLA A

COMUNIDAD	ENVIO	
	ARMAZON (€ por armazon)	ACCESORIOS (€ por bulto)
ANDALUCIA	20,5	10,0
ARAGON	20,0	9,5
ASTURIAS	21,0	10,0
CANTABRIA	20,0	9,0
CASTILLA LA MANCHA	20,0	9,0
CASTILLA LEON	20,5	9,0
CATALUNYA	12,0	6,0
COMUNIDAD VALENCIANA	18,5	8,5
EUSKADI	20,5	9,5
EXTREMADURA	21,0	10,0
GALICIA	21,0	10,0
ISLAS BALEARES	26,0	18,0
ISLAS CANARIAS	70,0	55,0
LA RIOJA	19,0	8,5
MADRID	20,0	9,5
MURCIA	19,5	8,5
NAVARRA	20,0	9,5
ANDORRA	37,0	20,0

\*P.D. valor en Euros

El precio de transporte para el material suelto se calcula con las siguientes formulas:

Armazón: nº de unidades de armazones x precio envio armazon

Accesorios: nº de unidades de jambas x precio envio bulto

Armazones + accesorios: (nº de unidades de armazones x precio envio armazon) + (nº de unidades de accesorios x precio envio bulto)



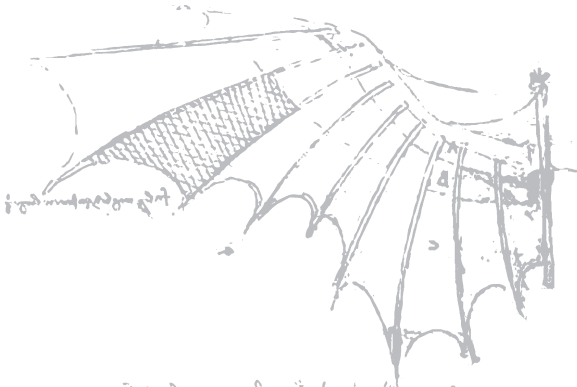

A  
B  
C

Handwritten text, possibly a legend or description, located below the drawing. The text is mirrored and appears to be bleed-through from the reverse side of the page. It includes the letters A, B, and C, which correspond to labels in the drawing above.

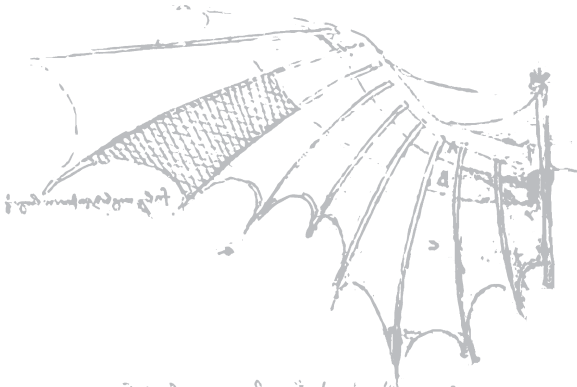

A  
B  
C

Handwritten text, likely a legend or description, oriented upside down relative to the drawing above it.

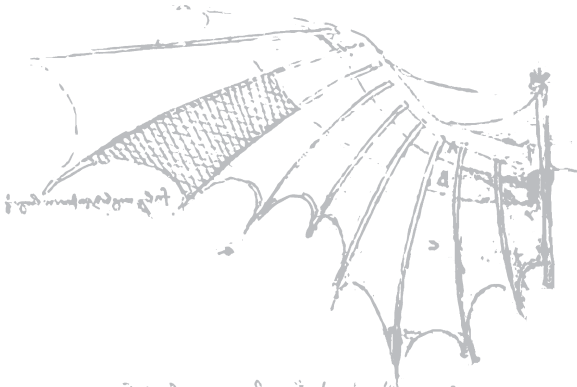

A  
B  
C  
D

Handwritten text, possibly a legend or description, located below the drawing. The text is mirrored and appears to be bleed-through from the reverse side of the page.

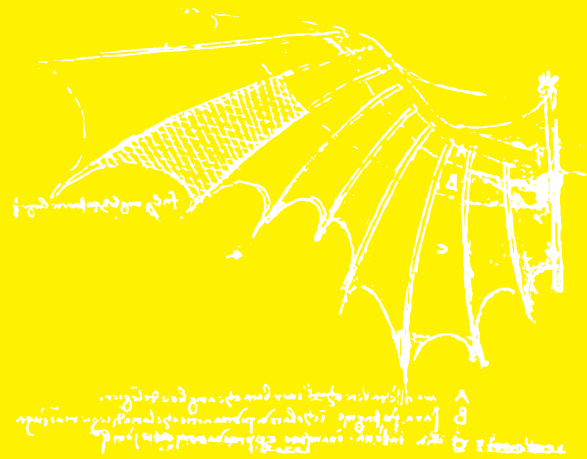

TKKR0LIS03504 - 10\_2021

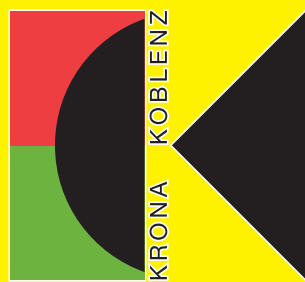

[www.kronakoblenz.com](http://www.kronakoblenz.com)

*pair de d'obres*

