













TRÈS







DESIGNED AND PRODUCED IN BARCELONA

2025









CARACTERÍSTICAS

-  Novedad
-  Desagüe automático incluido
-  Válvula Simple-Rapid incluida
-  Barra de ducha telescópica
-  Indicado para personas con discapacidades físicas
-  Funciona con alimentación eléctrica
-  Funciona con alimentación a pilas
-  Rociador de latón
-  Rociador de acero inoxidable
-  Rociador de ABS
-  Ducha de mano de latón
-  Ducha de mano de acero inoxidable
-  Ducha de mano de ABS



RECAMBIOS

-  Cartucho (referencia del recambio)
-  Montura (referencia del recambio)
-  Distribuidor (referencia del recambio)
-  Volante + cartucho (referencia del recambio)

INDICACIONES

-  Ángulo de giro del caño
-  Excentricidad especial
-  Funciones del rociador (litros/minuto)
-  Funciones de la ducha de mano (litros/minuto)
-  Funciones de los jets (litros/minuto)
-  Tiempo de apertura (en segundos)
-  Frío (indicador del volante)
-  Caliente (indicador del volante)

TECNOLOGÍA

-  Ducha con sistema de Cromoterapia
-  Cartucho Tres Therm 77®
-  Cartucho Tres Instant 77®
-  Cartucho Tres Instant 57®
-  Touch-Cool®: La superficie del grifo siempre está fría
-  Easy-Clean®: Fácil acceso y mantenimiento del cartucho
-  Cold-Tres®: El grifo siempre se abre con agua fría
-  Tres-Duo®: En la posición intermedia se consume la mitad
-  Easy-install®: Fácil bloqueo del grifo

TRÈS

DESIGNED AND PRODUCED IN BARCELONA
2025

Los productos mostrados en este catálogo pueden sufrir leves modificaciones por exigencias de diseño, siempre en beneficio del artículo.

Los precios de este catálogo son recomendados de venta al público y no incluyen el IVA.

Ante posibles errores de impresión, los precios revisados y definitivos aparecen siempre en la web de Tres.

Para conocer la disponibilidad de los productos, consulte la página web.

A través de la página web puede estar al día de las novedades de Tres o consultar si un producto ha sido descatalogado.



Tres **fabrica** productos **accesibles** donde el **diseño** y la **experiencia de uso** sean el pilar fundamental y ayuden a hacer más agradable el **consumo responsable del agua**.

CONTENIDO

31 COLECCIONES

Exclusive

- 32 Mont Blanc
- 40 Tres Clasic
- 60 Slim
- 76 Study
- 94 Cuadro

Selection

- 114 Loft
- 128 Fuji
- 140 Project-tres
- 154 Max
- 168 Lex-Alp
- 182 Class

Essential

- 192 Flat
- 204 Canigó Plus
- 216 Canigó
- 228 Base Plus
- 240 Base
- 250 Ese-23

257 ESPACIO DE DUCHA

Electrónicos

- 258 Shower technology

Termostáticos

- 270 Empotrados B-system
- 280 Empotrados Therm-box
- 294 Murales Over-wall

Monomandos

- 318 Empotrados Rapid-box
- 338 Murales

347 COMPLEMENTOS DE DUCHA

- 354 Rociadores

- 371 Duchas de mano

- 377 Flexos

- 380 Barras deslizantes

- 390 Kits de ducha

- 394 Soportes y tomas de pared

- 397 Codo adaptador a pared

- 398 Jets

403 SOLUCIONES EMPOTRADAS

409 ACCESORIOS DE BAÑO

- 410 Cuadrado

- 411 Redondo

- 412 Clásico

417 TECNOLOGÍA ELECTRÓNICA

- 419 Lavabos
- 425 Dispensadores de jabón
- 426 Sensores WC
- 426 Secador de manos
- 427 Cocina electrónica

429 ESPACIO DE COCINA

- 436 Monomandos
- 446 Para agua filtrada
- 450 Con caño abatible
- 450 Con caño flexible
- 452 Con caño extraíble
- 455 Electrónicos
- 456 Bimandos
- 459 A muro
- 462 Industriales
- 464 Grifos para varios usos

467 COLECTIVIDADES

- 468 Grifos para exterior
- 470 Grifos temporizados
- 476 Grifos medicales
- 477 Grifos para peluquería
- 478 Grifos para varios usos

481 COMPLEMENTOS DE GRIFERÍA

- 482 Válvulas y desagües
- 491 Sifones
- 495 Llaves de paso
- 497 Conexiones acodadas
- 499 Caños
- 501 Florones
- 502 Excéntricas
- 504 WC Systems
 - 506 Mecanismos de llenado
 - 507 Mecanismos de descarga
- 510 Tres Cleaner
 - 513 Limpiador de grifería

515 ANEXO

- 516 Instalación recomendada
- 518 Recambios
- 522 Listado de referencias
- 534 Condiciones de venta

COLECCIONES

EXCLUSIVE



Mont Blanc



Tres Clasic



Slim

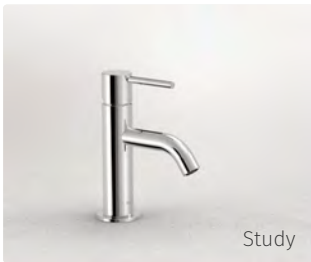

Study



Cuadro

SELECTION

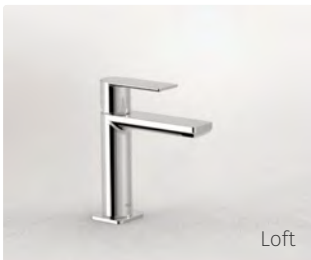

Loft

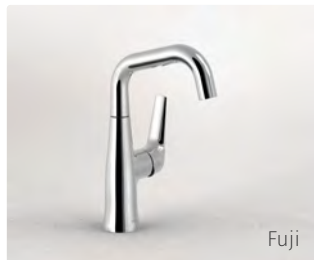

Fuji



Project-tres

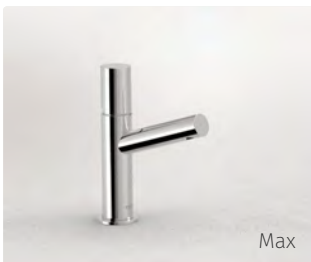

Max

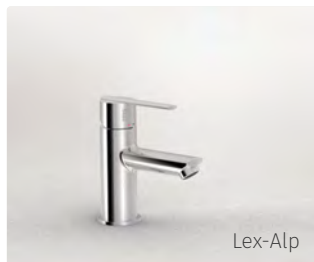

Lex-Alp



Class

ESSENTIAL

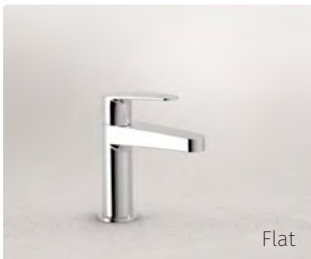

Flat



Canigó Plus

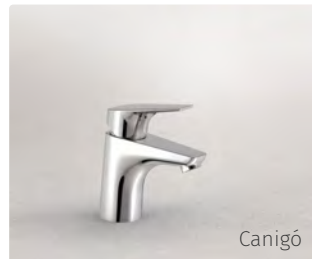

Canigó

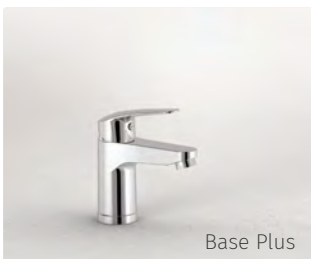

Base Plus

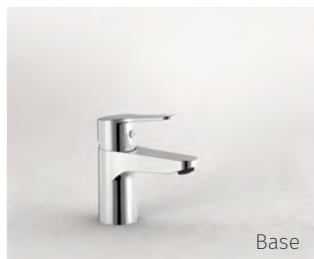

Base



Ese-23

ESPACIO DE DUCHA

ELECTRÓNICOS

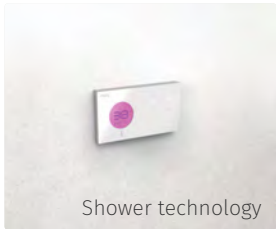

Shower technology

TERMOSTÁTICOS



B-system

MONOMANDOS

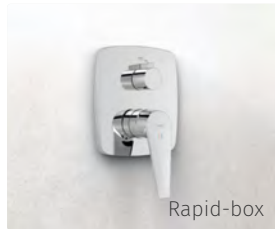

Rapid-box

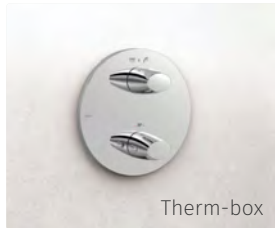

Therm-box



Mural



Over-wall

ESPACIO DE COCINA



Monomandos



Para agua filtrada



Con caño flexible



Con caño extraíble



Con caño abatible



Electrónicos



Bimandos

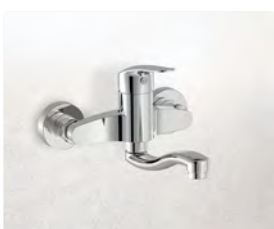

A muro



Industriales



Para varios usos

Para garantizar la máxima calidad en sus productos, Tres controla todo el proceso de fabricación en sus instalaciones, desde que se concibe la idea, hasta que se hace realidad.

Tres invierte en I+D para desarrollar sus propias tecnologías y patentes y poderlas integrar en su grifería. Las modernas instalaciones permiten investigar con innovaciones para la ducha, sistemas ecoeficientes y nuevos usos de la grifería para adaptarla a la demanda del mercado.

Tres ha sido pionero en el desarrollo de grifería con sistemas de ahorro de agua, patentando soluciones que se han utilizado en todo el mundo. También es especialista en grifería termostática e investiga nuevas maneras de experimentar con el agua en la ducha.

La electrónica ya es una realidad en el desarrollo de los productos. El uso intuitivo de un grifo de lavabo contactless, duchas que permiten tener un control total del agua y la temperatura, mecanismos eficaces de ahorro de agua, grifos inteligentes... Todo ello para formar parte de los baños y cocinas del futuro.

DESIGNED AND
PRODUCED IN
BARCELONA



ESPÍRITU INDUSTRIAL E INNOVADOR



1968

Jaume Tres revolucionó el sector del vino patentando un nuevo grifo para barricas que mejoraba el cierre hermético.

1968

La familia Tres montó un pequeño taller mecánico en Ordal (Barcelona), equipado con maquinaria de segunda mano, con el fin de realizar pequeñas reparaciones para el pueblo, soldaduras para terceras personas o encargos a cerrajeros.



1971

Aparte de sus labores como taller, empiezan con la mecanización y montaje de grifos de vino para poderlos comercializar con su propia marca. También suministran piezas para varios fabricantes de grifería.



1972

La actividad que les proporcionaba mejores beneficios era la grifería de vino, por lo que decidieron dedicarse exclusivamente a su producción, abandonando las tareas como taller de reparaciones.

1975

El aprendizaje constante y la experiencia adquirida desemboca en la ampliación del negocio incorporando la fabricación de grifos para baño y cocina. Tres lanza al mercado español su primer grifo monomando.



1985

Se decide prescindir de la producción externa de partes de sus grifos para empezar a fabricar íntegramente en el taller. Poco a poco todo el proceso de fabricación se realiza exclusivamente en Tres.

1993

Tres amplía sus instalaciones trasladando parte de su producción en Vallirana (muy cerca de la fábrica inicial de Ordal), con un complejo de naves y oficinas de más de 35.000 m².

1994

Tres desarrolla y patenta uno de sus inventos más expandidos: los primeros monomandos ecológicos del mercado, que ahorran agua y energía de forma efectiva y condicionan la forma en que las industrias de grifería se acercarán a la sostenibilidad.

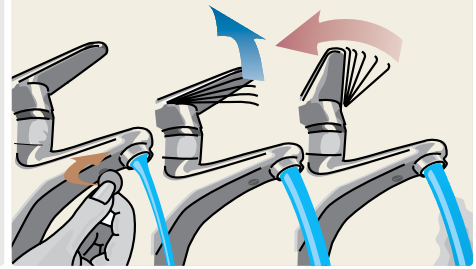

2011

Nace la Fundación Jordi Tres Casas, dando trabajo de calidad a personas con riesgo de exclusión social.

2016

Tres empieza a ejecutar proyectos enfocados en las nuevas tecnologías e incorpora la electrónica en el diseño de sus productos.

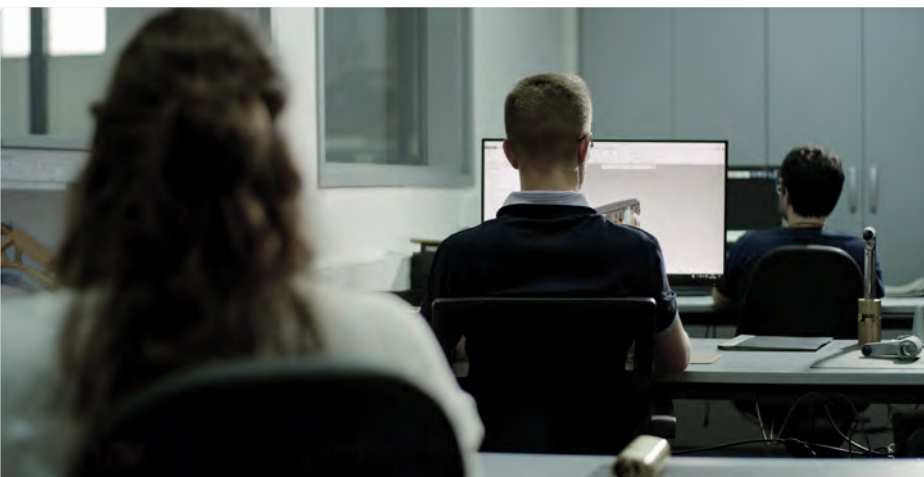

2025

Conoce Tres desde dentro:



INDUSTRIA RESPONSABLE

Queremos reducir al máximo posible nuestro impacto al planeta fabricando con materiales de calidad y de origen europeo y cumpliendo con las normas de seguridad más exigentes. También queremos contribuir a mantener un buen equilibrio ecológico desarrollando procesos de fabricación más eficientes, economizando el transporte y aplicando las medidas de reciclaje, reutilización y transformación que tenemos a nuestro alcance.



Autoconsumo de energía a través de placas solares.



Embalaje de cartón autoproducido, **reduciendo el uso de plásticos** y transporte.



Los grifos están **fabricados con latón** refinado en Europa, de bajo contenido en plomo, siguiendo la Norma Europea (UNE-EN 10204).



La grifería de Tres está disponible en diferentes acabados. Todos ellos se aplican mezclando el **proceso industrial** con el **control artesanal** para ofrecer un resultado perfecto y resistente.



Tres ofrece **hasta 5 años de garantía** para muchos de los productos más vendidos.



El **laboratorio de última generación** está equipado para ensayos acústicos según norma Europea EN 200-2008, estudiando el producto para reducir el consumo de agua y de energía.



La verificación visual y funcional del 100% de las piezas, junto con los cauchos sin emigración y las grasas no tóxicas, hacen que los productos **superen todas las constantes auditorías** de los organismos oficiales Europeos que realizan en las instalaciones.



Tanto los productos como los procesos de producción están **certificados** por los principales organismos.



①

Diseño

Se idean las colecciones y se diseña la grifería.

②

Ingeniería

Se industrializa el producto y se hacen las mejoras tecnológicas.

③

Electrónica

Diseño y programación electrónica

④

Fundición

Los moldes dan forma a las piezas a través de la fundición del latón.



⑤

Mecanizado

Mecanizamos todas las cavidades con máquinas de alta precisión.

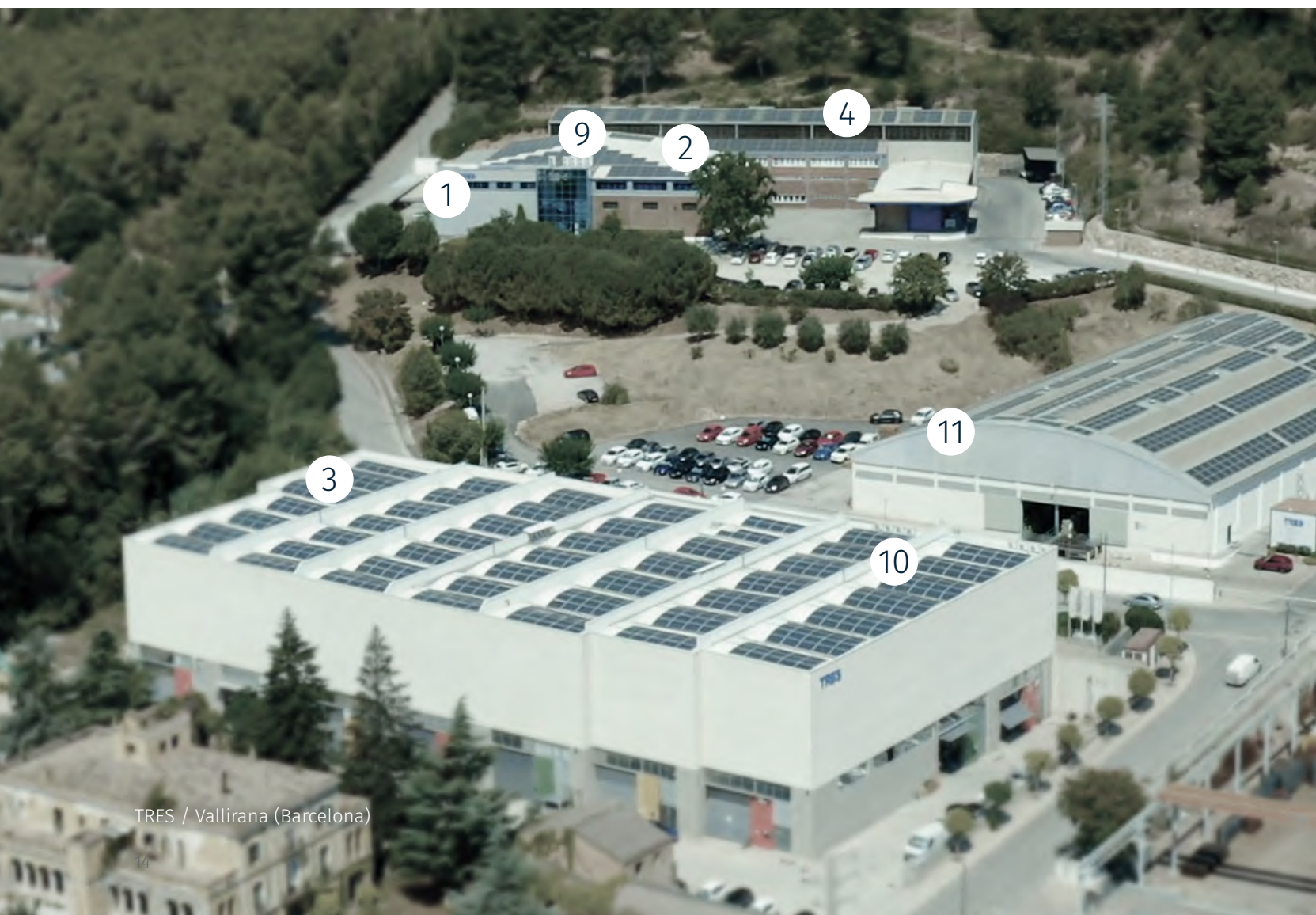

⑥

Pulidores

Pulimos todas las superficies de cada grifo mediante robots.



⑦

Baños

Las piezas pasan por los baños para conseguir el acabado final.



⑧

Montaje

Se instalan los componentes y se verifica el grifo para dejarlo terminado.



⑨

Laboratorio

Los productos pasan exhaustivas pruebas de calidad en el laboratorio.

⑩

Embalaje

Autofabricación del embalaje y expositores

Expedición

Los pedidos se distribuyen diariamente para todo el mundo.



GRIFERÍA CON PERSONALIDAD

Para conseguir todos los acabados que Tres ofrece, se necesita de un proceso que garantice la calidad y durabilidad. Todo este proceso industrializado consigue la máxima resistencia a la corrosión y la máxima uniformidad en la superficie, es decir, crea un acabado perfecto. Además, todas las piezas se revisan y completan a mano para conseguir la excelencia. Dado que todo el proceso se desarrolla en las instalaciones de Tres, los productos mantienen el mismo tono y las mismas cualidades para acertar siempre en la elección.



La grifería cromada utiliza el revestimiento Tres-Micron®, que ofrece una perfecta nivelación de espesores en las superficies irregulares de las piezas. Este proceso galvánico garantiza una altísima resistencia al desgaste con un brillo duradero e inalterable.



El proceso de cromado conlleva varios pasos. Los primeros baños sirven para limpiar las piezas de grasa y polvo; después, los baños de níquel, que hacen cambiar el color del latón; finalmente se pasa a los baños en los que, con electrolisis, se incrusta el cromado en el latón.



Para realizar los acabados de acero, latón viejo (brillante o mate) o negro metalizado se añade pintura epoxi de alta calidad, apta para grifería.











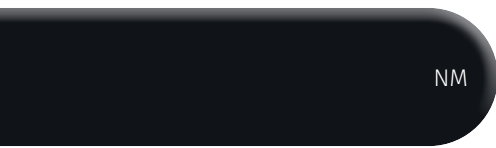
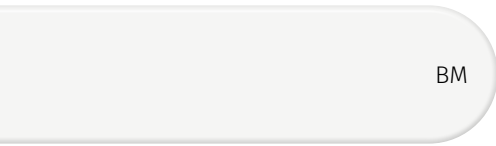

Los acabados en oro se elaboran mediante un proceso muy similar al del cromado, salvo que en el último paso se aplica un baño en oro de 24 quilates.



Para pintar las piezas con acabados en colores se utiliza pintura ecológica libre de disolventes; estos acabados incorporan características como la anticorrosión y la durabilidad o estabilidad en el tiempo.



























Para los grifos en acabado oro y oro rosa, tanto brillante como mate, se realiza un baño con oro real de 24 quilates, dando más naturalidad y valor a la pieza, convirtiendo cada pieza en una auténtica joya.

	CR	Cromado
	NM	Negro mate
	BM	Blanco mate
	AC	Acero
	KM	Negro metalizado
	KMB	Negro bronce
	OR	Oro 24k
	OM	Oro mate 24k
	OP	Oro rosa 24k
	OPM	Oro rosa mate 24k
	LV	Latón viejo
	LM	Latón viejo mate

Tres ha volcado todo su potencial en poder crear singularidad en cada producto que ofrece. Todos los acabados disponibles para sus grifos son prueba de ello. La exclusividad, resistencia y seguridad de estos acabados se traduce en unas piezas de diseño que imprimen carácter e individualidad para el baño o la cocina.



		CR	NM	BM	AC	KM	KMB	OR	OM	OP	OPM	LV	LM	AM	RO	ME	BL
Mont Blanc		32	•	•	•			•			•						
Tres Clasic		40	•		•			•				•	•				
Slim		60	•	•	•		•	•	•								
Study		76	•	•	•	•	•	•	•	•	•			•	•		
Cuadro		94	•	•	•			•	•							•	•
Loft		114	•	•	•			•	•							•	•
Fuji		128	•	•	•						•						
Project-tres		140	•	•	•	•	•	•	•	•	•						
Max		154	•														
Lex-Alp		168	•														
Class		182	•														
Flat		192	•														
Canigó Plus		204	•														
Canigó		216	•														
Base Plus		228	•	•													
Base		240	•														
Ese-23		250	•														
Shower technology		258	•	•					•		•						
B-system		270	•	•	•			•	•	•	•						
Therm-box		280	•	•	•	•	•	•	•	•	•						
Over-wall		294	•	•	•	•	•		•		•						
Rapid-box		318	•	•	•	•	•	•	•	•	•						
Accesorios		409	•	•	•	•	•	•	•	•	•	•	•				
Cocina		429	•	•	•	•		•	•			•	•				

GRIFOS PARA TODA LA VIDA

La durabilidad de los productos Tres evita una obsolescencia prematura, generando menos impacto ambiental. La creación de los nuevos productos tiene en cuenta el ahorro de agua y energía para ofrecer un producto seguro y eficiente que sea amable con el medio ambiente sin perder su funcionalidad. Tres ofrece soluciones para cualquier instalación preparadas para adaptarse a las certificaciones más exigentes.

TECNOLOGÍA ECOEFICIENTE



Cold-tres

Sistema de bajo consumo energético en el que **el grifo se abre siempre con agua fría**, evitando el encendido innecesario del calentador. Ideado y patentado por Tres desde 1992.



Tres duo

Sistema de bajo consumo de agua con una **apertura de la maneta en dos posiciones**. En la posición intermedia se consume el 50% del agua. Ideado y patentado por Tres desde 2010.

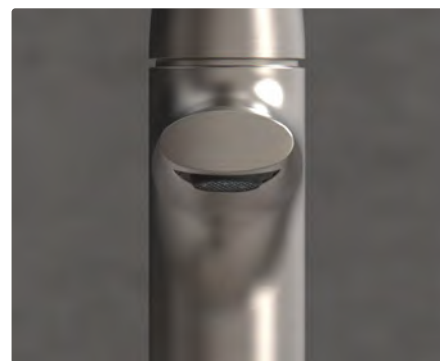

Aireador orientable con limitador de caudal a 5,7 lpm, para consumir menos del 50% de agua que en los grifos habituales, manteniendo el confort.



Los grifos están **fabricados con latón** refinado en Europa, de bajo contenido en plomo, siguiendo la Norma Europea (UNE-EN 10204).



Recubrimiento con cromado Tres-Micron®, que garantiza una superficie duradera, resistencia al paso del tiempo y facilidad de limpieza de la grifería.



Grifería de **diferente altura** para adaptarse a los distintos modelos de lavamanos del mercado.

				
BR1	5	5	6	8
BR2	1,9	3,8		6
BR3	-	1,9		

Limitadores de caudal BR en la grifería, que permiten acceder a certificaciones como Breeam, Leed y Edge.



Cartucho con discos cerámicos que proporcionan un funcionamiento suave del mando. Diseñados y patentados por Tres, tienen una vida útil certificada de 200.000 ciclos (Aenor-NF).



Sistema antiquemaduras **Protec-tres**. El anillo del cartucho permite limitar la temperatura máxima deseada.

SOLUCIONES EMPOTRADAS

La grifería empotrada es aquella que se instala de forma interna a la pared, quedando a la vista simplemente la parte esencial.

Este tipo de instalación es perfecta para los cuartos de baño que persigan un diseño más discreto o minimalista, ofreciendo sensación de mayor amplitud y ligereza.

En Tres disponemos de diversos cuerpos internos para empotrar cada tipo de grifería.

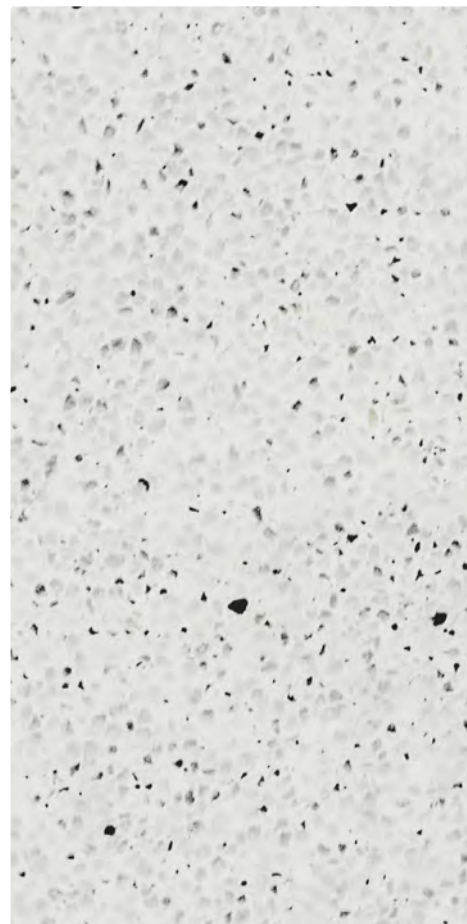

→65, 72, 82, 89, 404

Grifos de pie

Grifos para el lavabo o la bañera instalados con toma a suelo

→405

Lavabos murales

Grifos monomando empotrados para el lavabo

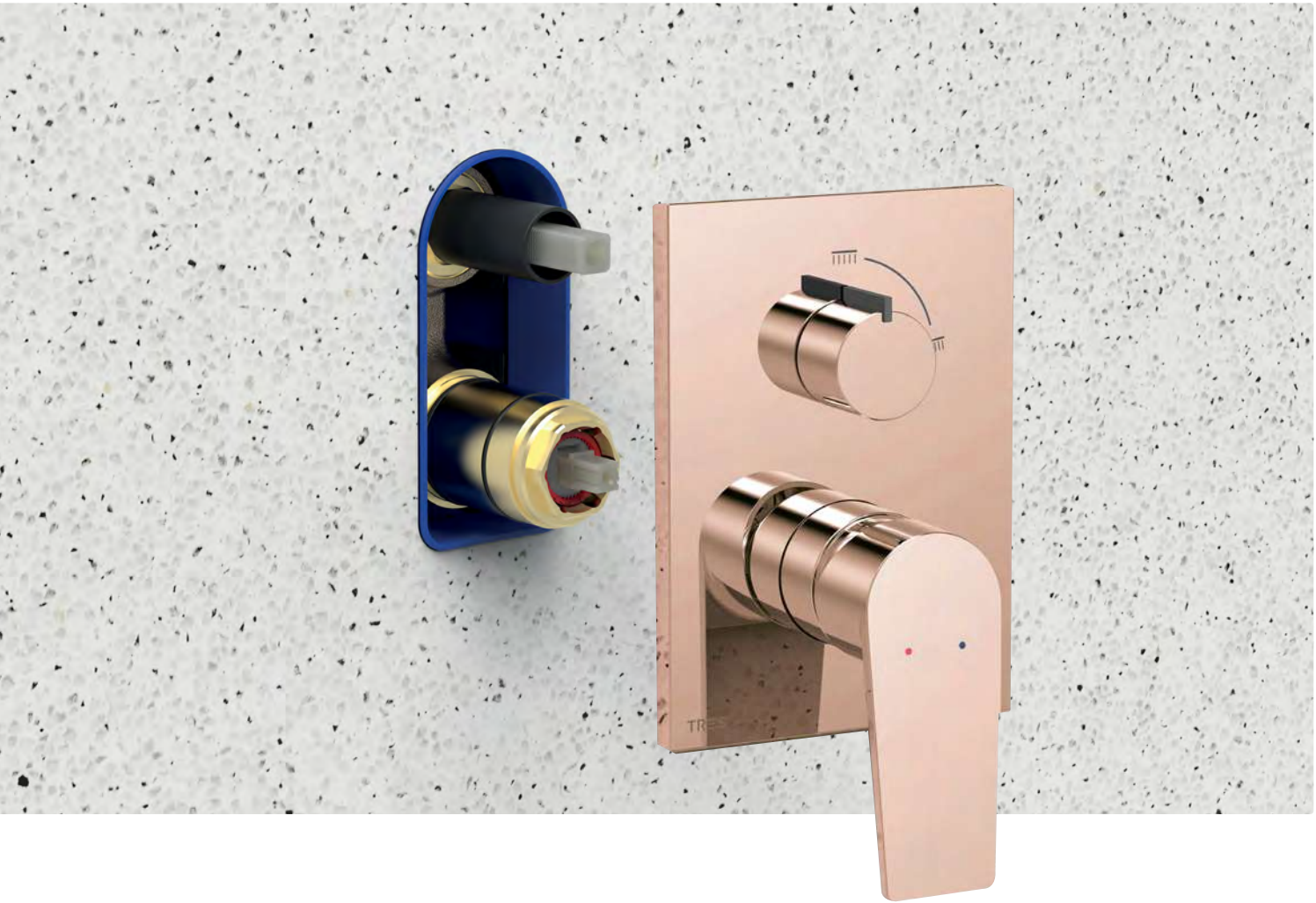

→258
Shower technology
 Kits termostáticos electrónicos de 2, 3 o 4 vías para la ducha



→270
B-system
 Kits termostáticos empotrados de 2, 3 o 4 vías para la ducha



→280
Therm-box
 Kits termostáticos empotrados de 2 vías para la ducha



→318
Rapid-box
 Kits monomando empotrados de 1, 2 o 3 vías para la ducha

CALIDAD Y CONTROL TOTAL

Los grifos termostáticos mezclan automáticamente el agua caliente y fría hasta conseguir, de forma constante, la temperatura elegida y a la vez regular el caudal. El grifo termostático es el que menos pérdida de agua produce y el que más optimiza la energía. Sus características permiten un control total del agua y garantizan una experiencia completa en la ducha.

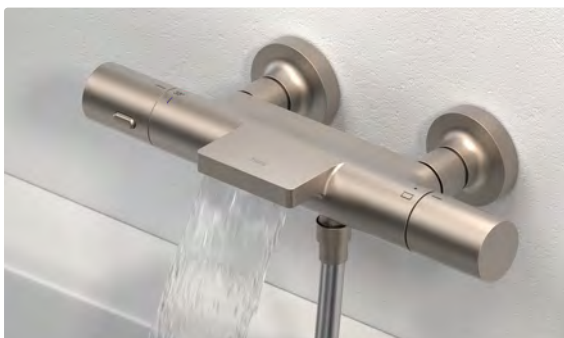

Grifos para bañera disponibles con salida de agua aireada o tipo cascada.

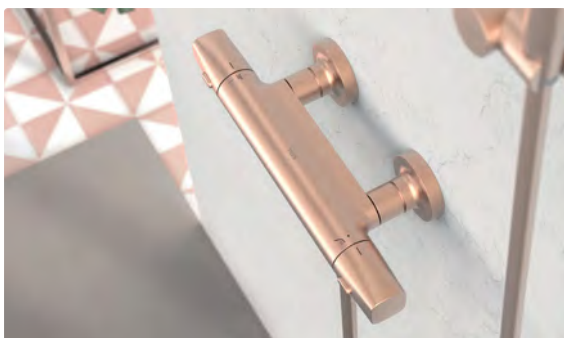

Grifos para ducha o bañera con ducha de mano, soporte y flexo.

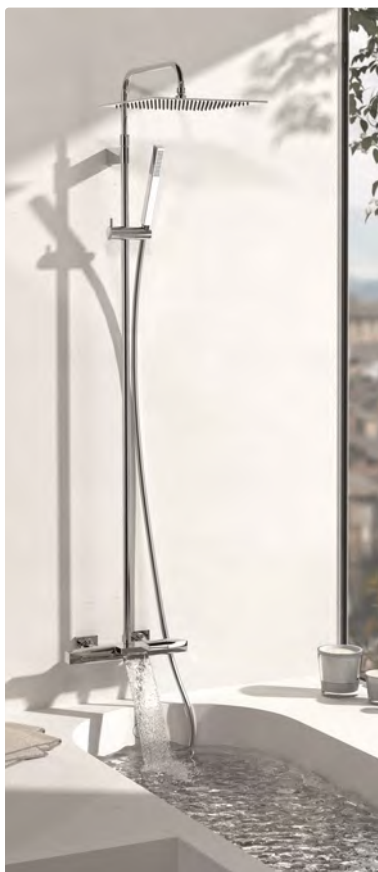

Conjuntos de 3 vías para bañera con salida de agua aireada o tipo cascada.

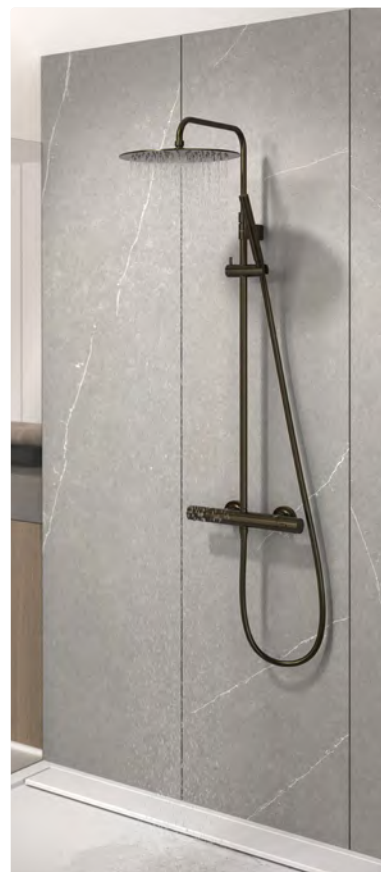

Más variedad de conjuntos de 2 vías para ducha.



Touch-cool

El circuito interno del agua provoca que el agua fría sea la que toque con la superficie y de este modo **el grifo siempre está frío al tacto, evitando quemaduras**. Ideado y patentado por Tres desde 2005.



Easy-clean

Tres ofrece la posibilidad de **limpiar fácilmente el cartucho** en caso de obstrucción sin perder su calibración.





Instant

El cartucho garantiza un **caudal de agua constante** a la temperatura deseada de ± 1 grado ante variaciones de presión y/o temperatura. Concebido para la desinfección de la legionela.

Diseños de volantes

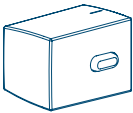
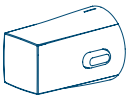
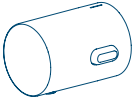
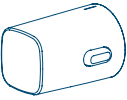
Las colecciones de ducha B-system, Therm-box y Over-wall tienen volantes de distintas formas que combinan con el resto de colecciones de Tres, permitiendo completar el baño con diseños adaptables.

		B-SYSTEM	THERM-BOX	OVER-WALL
	Cuadrado		•	•
	Cuadrado-redondo	•	•	•
	Redondo	•	•	•
	Bordes redondeados			•
	Ovalado		•	•
	En cruz		•	

SUSTITUYE EL BIDÉ Y APROVECHA ESPACIO







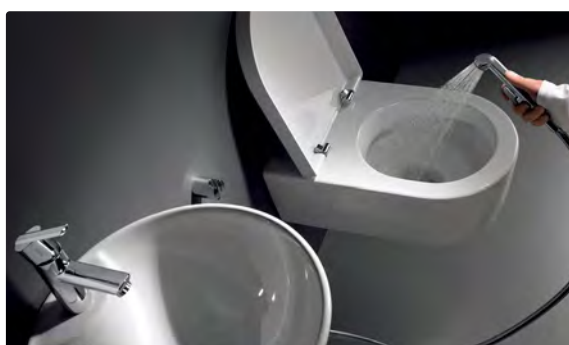
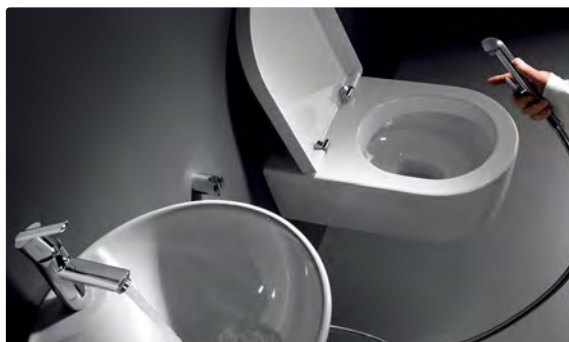







Sustituye el bidé tradicional por un grifo que aprovecha el recipiente del váter. La instalación es sencilla y no ocupa espacio. Puede optar por un monomando empotrado con soporte de ducha/bidé integrado, o bien utilizar el grifo del lavabo pero con una salida específica para la ducha-bidé. Dos opciones para adaptarte a los nuevos espacios y poner el baño al día.



Monomando mezclador empotrado con soporte de ducha-bidé integrado.



Monomando especial de lavabo con una salida específica para la ducha-bidé.
 Instalación sencilla utilizando la toma de agua compartida con el monomando de lavabo.

	Study Max	134123 134122*	→84 →160	
	Cuadro	00612301 00612302*	→103	
	Loft	20522301 20522201*	→121	
	Fuji	28112301	→134	
	Lex	181223 181222*	→174	
	Canigó	21712301	→220	
	Lex	181113	→174	

* Opción para paredes de Pladur.

COCINAS PARA TODOS LOS GUSTOS

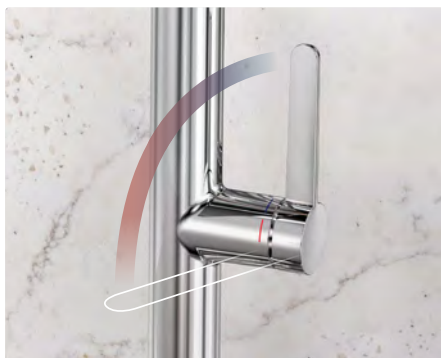

Sistema Cold-tres: el grifo se abre siempre con agua fría en la posición central de la maneta y el consumidor decide cuando utilizar agua caliente, lo que supone un bajo consumo de energía y agua.



La base está integrada al cuerpo del grifo, facilitando la instalación y la limpieza de la superficie.



Toda la grifería de cocina incorpora el sistema de bloqueo Easy-install, una sujeción reforzada del grifo con un simple movimiento.



Nuevos modelos de grifería con caño abatible. La altura total con el caño abatido es **solo de 6 cm**.



La maneta está situada a una altura especial respecto a la encimera para mayor comodidad.



Grifo electrónico accionado mediante sensor de infrarrojos. Regulación del caudal a través del sensor. Con regulación de temperatura mediante volante en el cuerpo.



2 tipos de chorro (aireador o efecto ducha) accionables mediante botón.



Fijación del caño al soporte mediante imán.



Un solo grifo para agua de red y agua filtrada. Con sistema táctil para agua filtrada.



El filtro purificador Seven+ de Tres proporciona una protección inmejorable contra los contaminantes y virus presentes en el agua, así como un agua de buen sabor.



Variedad de grifos para agua filtrada en acabados especiales para combinar con el resto de grifería.





EXCLUSIVE

32 Mont Blanc

40 Tres Clasic

60 Slim

76 Study

94 Cuadro

114 Loft

128 Fuji

140 Project-tres

SELECTION

154 Max

168 Lex-Alp

182 Class

192 Flat

204 Canigó Plus

216 Canigó

ESSENTIAL

228 Base Plus

240 Base

250 Ese-23



MONT BLANC

La colección Mont Blanc de Tres parte de una arquitectura simétrica construida bajo las premisas del diseño, la funcionalidad y el cuidado de todos los detalles. Con los característicos volantes en forma de cruz, esta revisión de la estética clásica permite más adaptabilidad y convierte sus piezas en algo atemporal y genuino.

CR

NM

AC

OM

OPM









GRIFOS PARA LAVABO

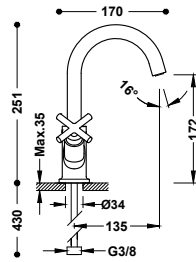

Grifo bimando para lavabo

Con volantes. Latiguillos de alimentación flexibles G3/8.

28310301	236,00
28310301NM	366,00
28310301AC	366,00
28310301OM	520,00
28310301OPM	520,00

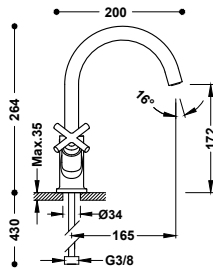
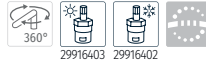

Grifo bimando alto para lavabo

Con volantes. Latiguillos de alimentación flexibles G3/8.

28320301	252,00
28320301NM	391,00
28320301AC	391,00
28320301OM	554,00
28320301OPM	554,00

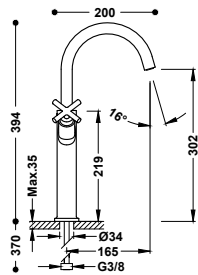
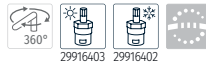

Grifo bimando XXL para lavabo

Con volantes. Latiguillos de alimentación flexibles G3/8.

28380301	294,00
28380301NM	456,00
28380301AC	456,00
28380301OM	647,00
28380301OPM	647,00

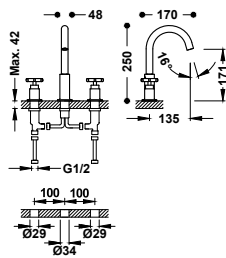
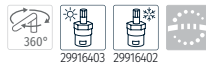

Grifo bimando de repisa para lavabo

De instalación libre. Con volantes.

28310501	315,00
28310501NM	488,00
28310501AC	488,00
28310501OM	693,00
28310501OPM	693,00

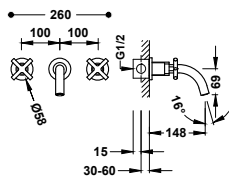

Grifo bimando empotrado para lavabo

Cuerpo empotrado incluido e indivisible. Con volantes. Caño de 148 mm.

28330001	289,00
28330001NM	448,00
28330001AC	448,00
28330001OM	635,00
28330001OPM	635,00



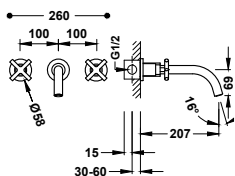

Grifo bimando empotrado para lavabo

Cuerpo empotrado incluido e indivisible. Con volantes. Caño de 207 mm.

■	28330002	299,00
■	28330002NM	464,00
■	28330002AC	464,00
■	28330002OM	658,00
■	28330002OPM	658,00



GRIFOS PARA BIDÉ

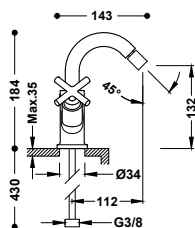

Grifo bimando para bidé

Rótula orientable. Con volantes. Latiguillos de alimentación flexibles G3/8.

■	28312001	239,00
■	28312001NM	371,00
■	28312001AC	371,00
■	28312001OM	527,00
■	28312001OPM	527,00



GRIFOS MURALES

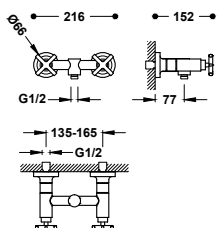

Grifo bimando mural para ducha

Ducha de mano anticalcárea de latón. Soporte orientable para ducha de mano. Flexo satinado.

■	28316301	336,00
■	28316301NM	521,00
■	28316301AC	521,00
■	28316301OM	739,00
■	28316301OPM	739,00

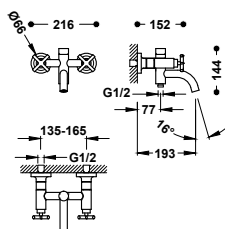

Grifo bimando mural para bañera y ducha

Ducha de mano anticalcárea de latón. Soporte orientable para ducha de mano. Flexo satinado.

■	28317601	404,00
■	28317601NM	627,00
■	28317601AC	627,00
■	28317601OM	889,00
■	28317601OPM	889,00





GRIFOS PARA BAÑERA

Grifo bimando de suelo para bañera y ducha

Con 2 columnas verticales de alimentación de agua a suelo. Ducha de mano anticalcárea de latón. Soporte fijo para ducha de mano. Flexo satinado.

■	28319401	578,00
■	28319401NM	895,00
■	28319401AC	895,00
■	28319401OM	1.271,00
■	28319401OPM	1.271,00

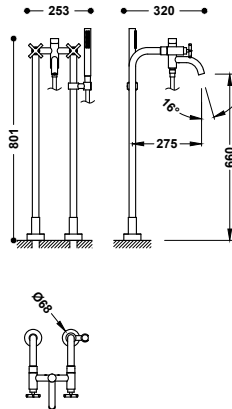

Tomas de agua acodadas de instalación a suelo para grifo de bañera

2 unidades con soporte fijo para ducha de mano.

■	161194	310,00
■	161194NM	481,00
■	161194AC	481,00
■	161194OM	682,00
■	161194OPM	682,00

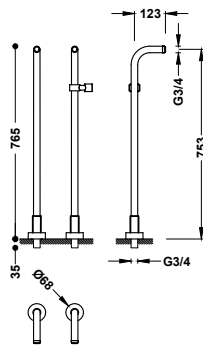

Tomas de agua acodadas de instalación a borde bañera para grifo de bañera

2 unidades con silenciador.

■	29987001	114,00
■	29987001NM	177,00
■	29987001AC	177,00
■	29987001OM	251,00
■	29987001OPM	251,00

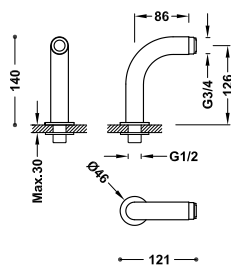

GRIFOS EMPOTRADOS

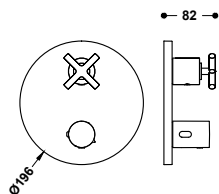

Pieza vista para caja empotrada de 2 vías Therm-box
 Sólo parte vista. Volante en cruz. Incluye placa embellecedora, mando y volante distribuidor. Completar con la caja empotrada Therm-box ref.: 20785001.

28325001	179,00
28325001NM	277,00
28325001AC	277,00
28325001OM	393,00
28325001OPM	393,00



Caja empotrada de 2 vías Therm-box con grifo termostático para ducha y bañera

20785001	130,00
----------	--------

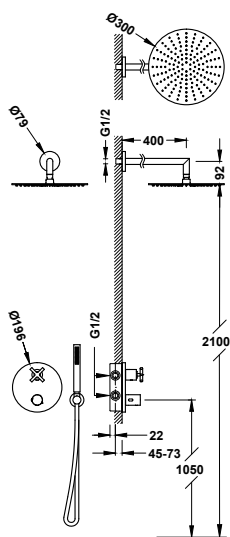

Kit de grifo termostático empotrado de 2 vías Therm-box para ducha

- Cuerpo empotrado incluido.
- Volante en cruz con control de temperatura. Distribuidor cerámico de 2 vías.
- Brazo a pared con rociador de ducha orientable y de acero inoxidable: Ø 300 mm.
- Soporte para ducha de mano con toma de agua a pared.
- Ducha de mano anticalcárea de latón.
- Flexo satinado.

28325002	625,00
28325002NM	899,00
28325002AC	899,00
28325002OM	1.224,00
28325002OPM	1.224,00





LLAVES DE PASO

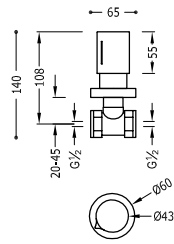

Llave de paso empotrada
Conexión a rosca hembra: 1/2".

06115501	83,00
06115501NM	128,00
06115501BM	128,00
06115501AC	128,00
06115501KM	128,00
06115501KMB	128,00
06115501OR	182,00
06115501OM	182,00
06115501OP	182,00
06115501OPM	182,00

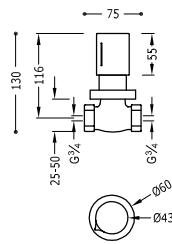

Llave de paso empotrada
Conexión a rosca hembra: 3/4".

06151101	91,00
06151101NM	140,00
06151101BM	140,00
06151101AC	140,00
06151101KM	140,00
06151101KMB	140,00
06151101OR	199,00
06151101OM	199,00
06151101OP	199,00
06151101OPM	199,00



TRES CLASIC

Su diseño se inspira en la grifería clásica pero con la tecnología actual. Con la colección Clasic de Tres se consigue el ambiente rústico, clásico y elegante que buscas. Los acabados especiales que presenta son perfectos para completar un baño inspirador.

CR

AC

OR

LV

LM

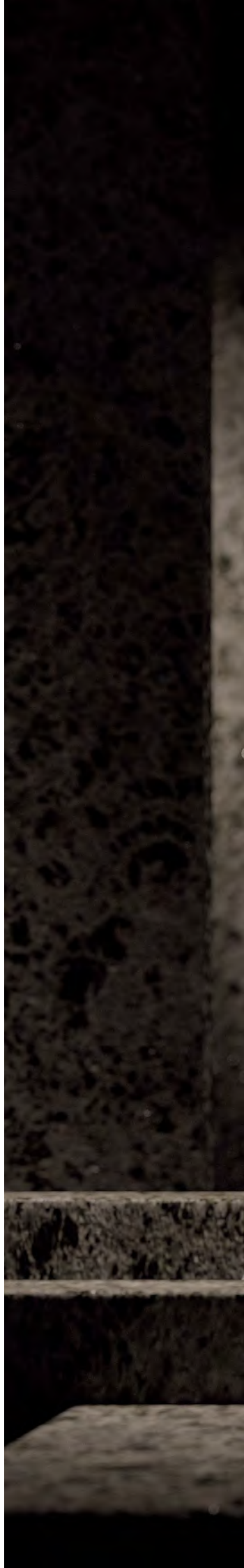





GRIFOS PARA LAVABO

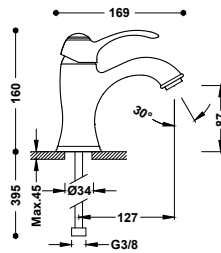

Grifo monomando para lavabo

Latiguillos de alimentación flexibles G3/8.



■	24210301	215,00
■	24210301AC	334,00
■	24210301OR	474,00
■	24210301LV	312,00
■	24210301LM	312,00

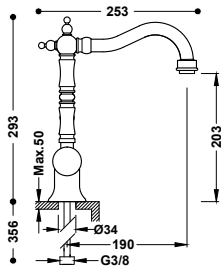

Grifo monomando con maneta lateral para lavabo

Latiguillos de alimentación flexibles G3/8.



■	24210801	252,00
■	24210801AC	391,00
■	24210801OR	554,00
■	24210801LV	365,00
■	24210801LM	365,00

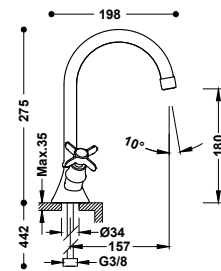

Grifo bimando para lavabo

Con volantes. Latiguillos de alimentación flexibles G3/8.



■	24210901	179,00
■	24210901AC	277,00
■	24210901OR	393,00
■	24210901LV	259,00
■	24210901LM	259,00

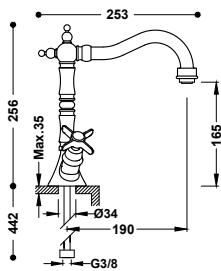

Grifo bimando para lavabo

Con volantes. Latiguillos de alimentación flexibles G3/8.



■	24210902	278,00
■	24210902AC	431,00
■	24210902OR	612,00
■	24210902LV	403,00
■	24210902LM	403,00

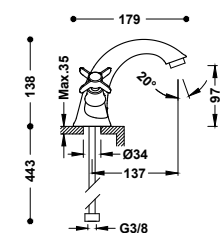

Grifo bimando para lavabo

Con volantes. Latiguillos de alimentación flexibles G3/8.



■	24210201	273,00
■	24210201AC	423,00
■	24210201OR	601,00
■	24210201LV	396,00
■	24210201LM	396,00

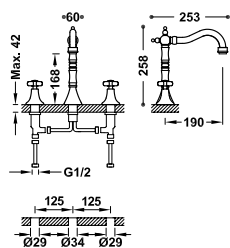

Grifo bimando de repisa para lavabo

De instalación libre. Con volantes.



■	24210501	383,00
■	24210501AC	594,00
■	24210501OR	843,00
■	24210501LV	556,00
■	24210501LM	556,00

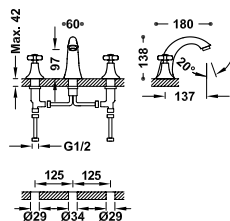

Grifo bimando de repisa para lavabo

De instalación libre. Con volantes.



■	24210601	326,00
■	24210601AC	505,00
■	24210601OR	716,00
■	24210601LV	472,00
■	24210601LM	472,00

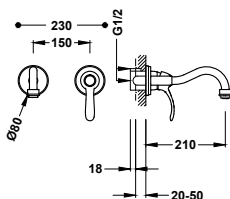

Grifo monomando empotrado para lavabo

Cuerpo empotrado incluido e indivisible. Caño de 210 mm.



■	24220001	263,00
■	24220001AC	407,00
■	24220001OR	578,00
■	24220001LV	381,00
■	24220001LM	381,00

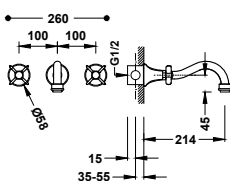

Grifo bimando empotrado para lavabo

Cuerpo empotrado incluido e indivisible. Con volantes. Caño de 214 mm.



■	24215101	284,00
■	24215101AC	439,00
■	24215101OR	624,00
■	24215101LV	411,00
■	24215101LM	411,00

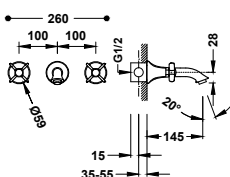

Grifo bimando empotrado para lavabo

Cuerpo empotrado incluido e indivisible. Con volantes. Caño de 145 mm.



■	24215102	305,00
■	24215102AC	472,00
■	24215102OR	670,00
■	24215102LV	442,00
■	24215102LM	442,00

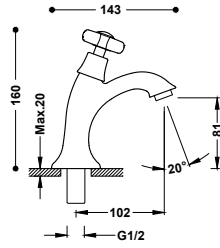

Grifo de 1 agua para lavabo
Con conexión roscada de G1/2.



24250301	104,00
24250301AC	156,00
24250301OR	222,00
24250301LV	146,00
24250301LM	146,00

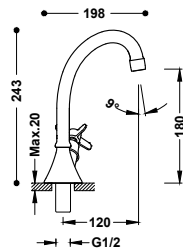

Grifo de 1 agua con volante lateral para lavabo
Con conexión roscada de G1/2.

24230601	106,00
24230601AC	164,00
24230601OR	233,00
24230601LV	154,00
24230601LM	154,00

GRIFOS PARA BIDÉ

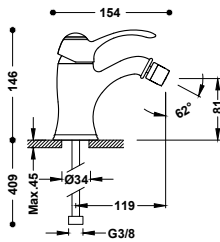

Grifo monomando para bidé
Rótula orientable. Latiguillos de alimentación flexibles G3/8.

24212001	226,00
24212001AC	350,00
24212001OR	497,00
24212001LV	327,00
24212001LM	327,00

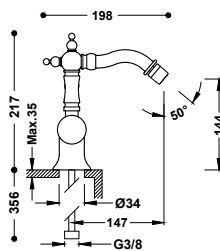

Grifo monomando con maneta lateral para bidé
Rótula orientable. Latiguillos de alimentación flexibles G3/8.

24222001	255,00
24222001AC	395,00
24222001OR	561,00
24222001LV	370,00
24222001LM	370,00

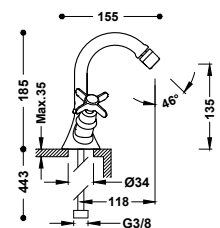

Grifo bimando para bidé
Rótula orientable. Con volantes. Latiguillos de alimentación flexibles G3/8.

24212201	186,00
24212201AC	288,00
24212201OR	409,00
24212201LV	269,00
24212201LM	269,00

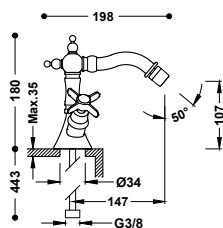

Grifo bimando para bidé

Rótula orientable. Con volantes. Latiguillos de alimentación flexibles G3/8.



■	24212202	289,00
■	24212202AC	448,00
■	24212202OR	635,00
■	24212202LV	419,00
■	24212202LM	419,00

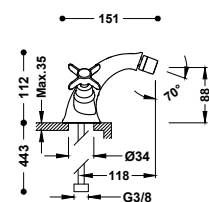

Grifo bimando para bidé

Rótula orientable. Con volantes. Latiguillos de alimentación flexibles G3/8.



■	24212101	284,00
■	24212101AC	439,00
■	24212101OR	624,00
■	24212101LV	411,00
■	24212101LM	411,00

GRIFOS MURALES

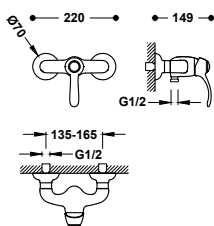

Grifo monomando mural para ducha

Ducha de mano anticalcárea de latón: Ø 78 mm. Soporte orientable para ducha de mano. Flexo metálico reforzado.



■	24216701	305,00
■	24216701AC	472,00
■	24216701OR	670,00
■	24216701LV	442,00
■	24216701LM	442,00

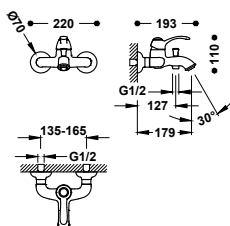

Grifo monomando mural para bañera y ducha

Ducha de mano anticalcárea de latón: Ø 78 mm. Soporte orientable para ducha de mano. Flexo metálico reforzado.



■	24217001	352,00
■	24217001AC	545,00
■	24217001OR	774,00
■	24217001LV	510,00
■	24217001LM	510,00

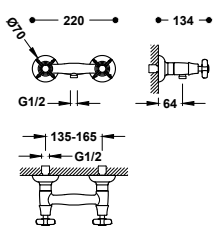

Grifo bimando mural para ducha

Ducha de mano anticalcárea de latón: Ø 78 mm. Soporte orientable para ducha de mano. Flexo metálico reforzado.



■	24216301	294,00
■	24216301AC	456,00
■	24216301OR	647,00
■	24216301LV	426,00
■	24216301LM	426,00

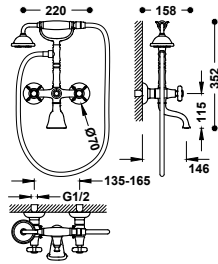

Grifo bimando mural para bañera y ducha

Ducha de mano anticálcarea de latón: Ø 78 mm. Soporte fijo para ducha de mano. Flexo metálico reforzado.

■	24217601	436,00
■	24217601AC	675,00
■	24217601OR	959,00
■	24217601LV	632,00
■	24217601LM	632,00

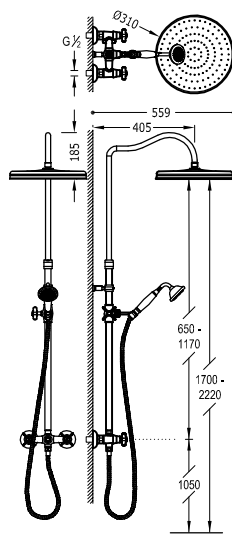
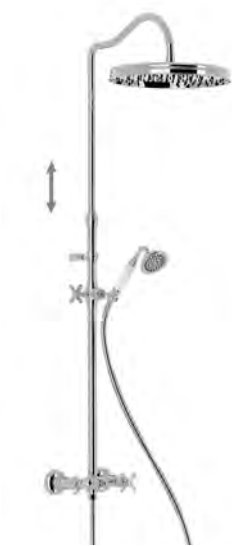

Conjunto de grifo bimando mural de 2 vías para ducha

- Barra de ducha telescópica.
- Rociador de ducha orientable de latón: Ø 310 mm.
- Soporte deslizante y orientable para ducha de mano.
- Ducha de mano anticálcarea de latón: Ø 78 mm.
- Flexo metálico reforzado.

■	24219101	1.003,00
■	24219101AC	1.555,00
■	24219101LV	1.454,00
■	24219101LM	1.454,00

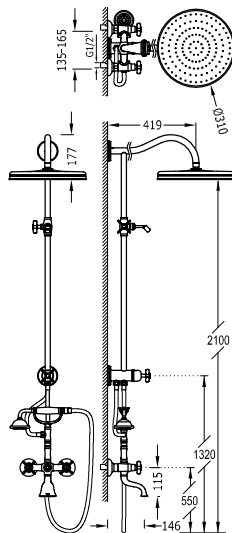
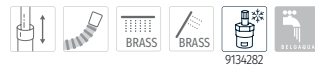

Conjunto de grifo bimando mural de 3 vías para bañera y ducha

- Con inversor integrado en la barra de ducha.
- Rociador de ducha orientable de latón: Ø 310 mm.
- Soporte deslizante y orientable para ducha de mano.
- Ducha de mano anticálcarea de latón: Ø 78 mm.
- Flexo metálico reforzado.

■	24217602	890,00
■	24217602AC	1.380,00
■	24217602LV	1.291,00
■	24217602LM	1.291,00

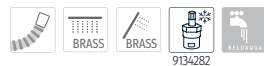

GRIFOS EMPOTRADOS

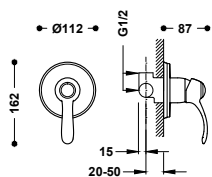

Grifo monomando empotrado de 1 vía para ducha

Cuerpo empotrado incluido.



24217701	116,00
24217701AC	179,00
24217701OR	254,00
24217701LV	167,00
24217701LM	167,00

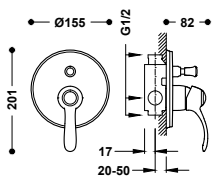

Grifo monomando empotrado de 2 vías para bañera y ducha

Cuerpo empotrado incluido. Inversor de 2 vías.



24218001	179,00
24218001AC	277,00
24218001OR	393,00
24218001LV	259,00
24218001LM	259,00

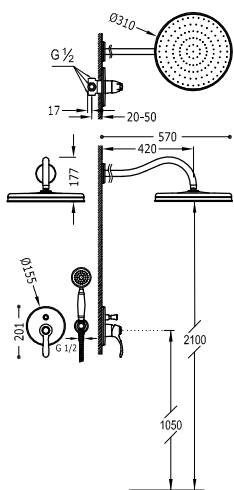

Kit de grifo monomando empotrado de 2 vías para ducha

- Cuerpo empotrado incluido.
- Inversor de 2 vías.
- Brazo a pared con rociador de ducha orientable y de latón: Ø 310 mm.
- Soporte para ducha de mano con toma de agua a pared.
- Ducha de mano anticalcárea de latón: Ø 78 mm.
- Flexo metálico reforzado.

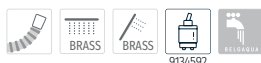

24218003	638,00
24218003AC	991,00
24218003OR	1.480,00
24218003LV	925,00
24218003LM	925,00

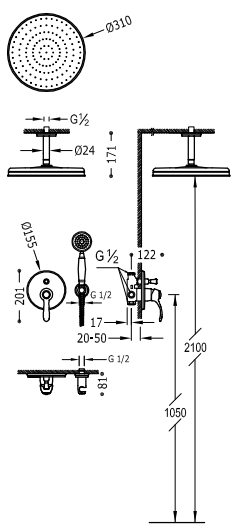

Kit de grifo monomando empotrado de 2 vías para ducha

- Cuerpo empotrado incluido.
- Inversor de 2 vías.
- Brazo a techo con rociador de ducha orientable y de latón: Ø 310 mm.
- Soporte para ducha de mano con toma de agua a pared.
- Ducha de mano anticalcárea de latón: Ø 78 mm.
- Flexo metálico reforzado.

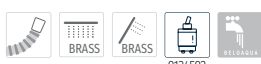

24218004	604,00
24218004AC	936,00
24218004OR	1.399,00
24218004LV	876,00
24218004LM	876,00

GRIFOS PARA BAÑERA

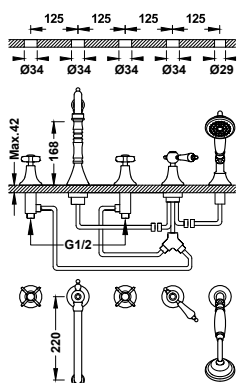

Grifo bimando para borde de bañera

- Con volantes e inversor.
- Ducha de mano anticalcárea de latón: Ø 78 mm.
- Caudal: 3 bar - 12 l/min.

	24214601	610,00
	24214601AC	945,00
	24214601OR	1.342,00
	24214601LV	884,00
	24214601LM	884,00



Válvula de desagüe Click-clack con rebosadero para bañera

	13453420	32,00
--	----------	-------

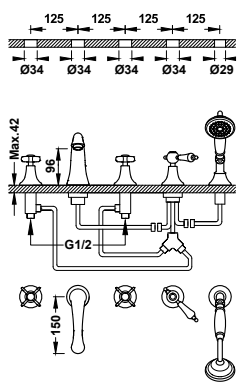

Grifo bimando para borde de bañera

- Con volantes e inversor.
- Ducha de mano anticalcárea de latón: Ø 78 mm.
- Caudal: 3 bar - 12 l/min.

	24214602	583,00
	24214602AC	903,00
	24214602OR	1.282,00
	24214602LV	845,00
	24214602LM	845,00

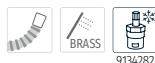

Válvula de desagüe Click-clack con rebosadero para bañera

	13453420	32,00
--	----------	-------

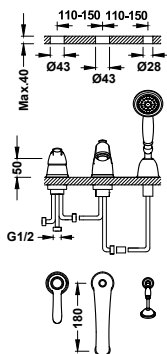

Grifo monomando para borde de bañera

- Inversor integrado en el caño de bañera.
- Ducha de mano anticalcárea de latón: Ø 78 mm.
- Caño de bañera de 180 mm. Caudal: 3 bar - 16 l/min.

	24214501	467,00
	24214501AC	724,00
	24214501OR	1.028,00
	24214501LV	678,00
	24214501LM	678,00



Válvula de desagüe Click-clack con rebosadero para bañera

	13453420	32,00
--	----------	-------



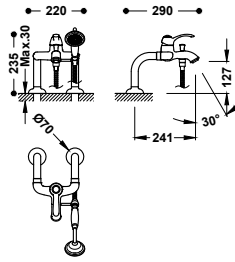

Grifo monomando para borde de bañera con tomas de agua acodadas

Con 2 tomas de agua acodadas. Ducha de mano anticalcárea de latón: Ø 78 mm. Soporte fijo para ducha de mano. Flexo metálico reforzado.

24219401	459,00
24219401AC	711,00
24219401OR	1.009,00
24219401LV	665,00
24219401LM	665,00

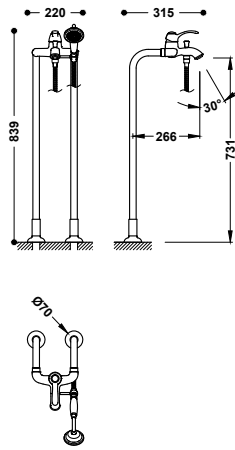

Grifo monomando a suelo para bañera y ducha

Con 2 columnas verticales de alimentación de agua a suelo. Ducha de mano anticalcárea de latón: Ø 78 mm. Soporte fijo para ducha de mano. Flexo metálico reforzado.

24219402	648,00
24219402AC	1.004,00
24219402LV	939,00
24219402LM	939,00

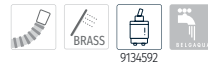

GRIFOS TERMOSTÁTICOS MURALES

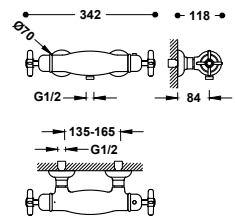

Grifo termostático mural para ducha

Ducha de mano anticalcárea de latón: Ø 78 mm. Soporte orientable para ducha de mano. Flexo metálico reforzado.

24216409	488,00
24216409AC	757,00
24216409OR	1.074,00
24216409LV	708,00
24216409LM	708,00

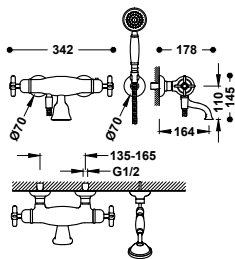

Grifo termostático mural para bañera y ducha

Con salida del agua en cascada. Inversor integrado en el regulador de caudal. Ducha de mano anticalcárea de latón: Ø 78 mm. Soporte orientable para ducha de mano. Flexo metálico reforzado.

24217409	541,00
24217409AC	838,00
24217409OR	1.190,00
24217409LV	784,00
24217409LM	784,00

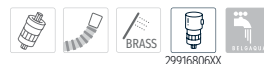

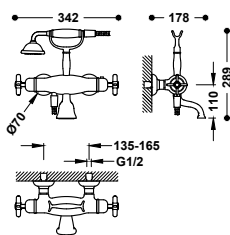

Grifo termostático mural para bañera y ducha

Con salida del agua en cascada. Inversor integrado en el regulador de caudal. Ducha de mano anticalcárea de latón: Ø 78 mm. Soporte fijo para ducha de mano. Flexo metálico reforzado.

24217609	683,00
24217609AC	1.058,00
24217609OR	1.502,00
24217609LV	990,00
24217609LM	990,00

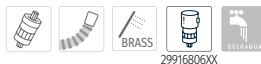

29916806XX

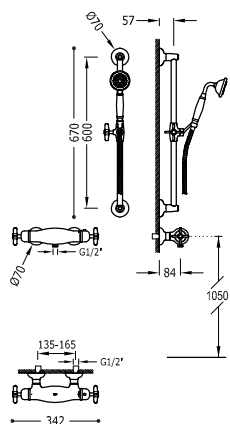

Kit de grifo termostático mural para ducha

· Barra de ducha: long. 600 mm.
· Soporte deslizante y orientable para ducha de mano.
· Ducha de mano anticalcárea de latón: Ø 78 mm.
· Flexo metálico reforzado.

24216402	625,00
24216402AC	969,00
24216402LV	906,00
24216402LM	906,00

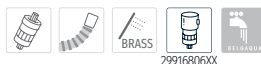

29916806XX

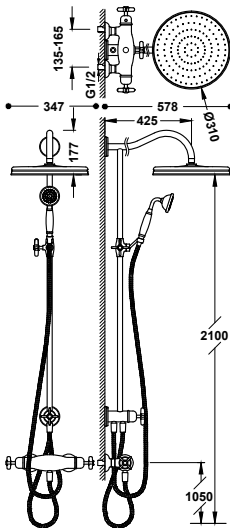

Conjunto de grifo termostático mural de 2 vías para ducha

· Con inversor integrado en la barra de ducha.
· Rociador de ducha orientable de latón: Ø 310 mm.
· Soporte deslizante y orientable para ducha de mano.
· Ducha de mano anticalcárea de latón: Ø 78 mm.
· Flexo metálico reforzado.

24219501	867,00
24219501AC	1.344,00
24219501LV	1.257,00
24219501LM	1.257,00

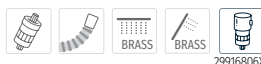

29916806XX

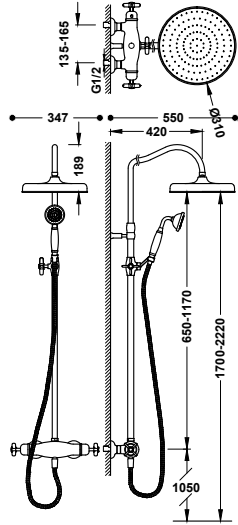

Conjunto de grifo termostático mural de 2 vías para ducha

- Con inversor integrado en el regulador de caudal.
- Barra de ducha telescópica.
- Rociador de ducha orientable de latón: Ø 310 mm.
- Soporte deslizante y orientable para ducha de mano.
- Ducha de mano anticalcárea de latón: Ø 78 mm.
- Flexo metálico reforzado.

24219502	1.039,00
24219502AC	1.610,00
24219502LV	1.507,00
24219502LM	1.507,00

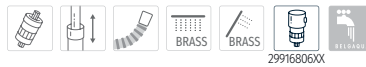

29916806XX

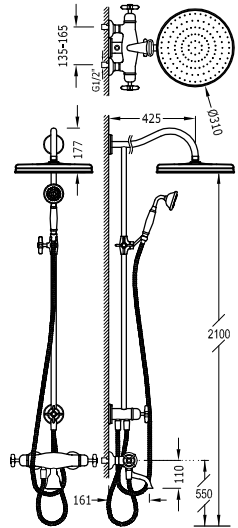

Conjunto de grifo termostático mural de 3 vías para bañera y ducha

- Con inversor integrado en el regulador de caudal y en la barra de ducha.
- Salida del agua en cascada.
- Rociador de ducha orientable de latón: Ø 310 mm.
- Soporte deslizante y orientable para ducha de mano.
- Ducha de mano anticalcárea de latón: Ø 78 mm.
- Flexo metálico reforzado.

24219801	964,00
24219801AC	1.494,00
24219801LV	1.398,00
24219801LM	1.398,00

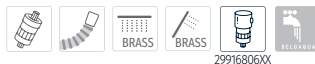

29916806XX

GRIFOS TERMOSTÁTICOS EMPOTRADOS

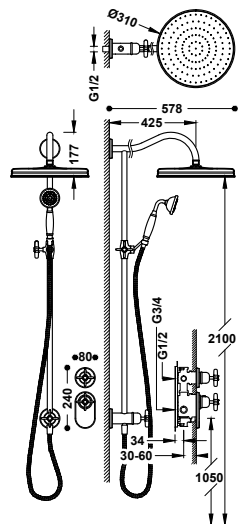

Kit de grifo termostático empotrado de 2 vías Block System para ducha

- Cuerpo empotrado termostático de instalación vertical incluido.
- Regulador de caudal y distribuidor de 1 vía.
- Conjunto de barra de ducha con rociador de ducha orientable de latón: Ø 310 mm.
- Inversor integrado en la barra de ducha.
- Soporte deslizante y orientable para ducha de mano.
- Ducha de mano anticalcárea de latón: Ø 78 mm.
- Flexo metálico reforzado.

24235203	1.021,00
24235203AC	1.583,00
24235203LV	1.480,00
24235203LM	1.480,00



29916802XX

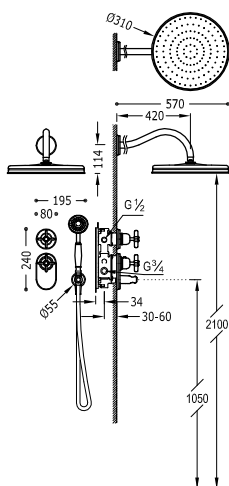

Kit de grifo termostático empotrado de 2 vías Block System para ducha

- Cuerpo empotrado termostático de instalación vertical incluido.
- Regulador de caudal y distribuidor de 2 vías.
- Brazo a pared con rociador de ducha orientable de latón: Ø 310 mm.
- Soporte para ducha de mano con toma de agua a pared.
- Ducha de mano anticalcárea de latón: Ø 78 mm.
- Flexo metálico reforzado.

24235202	1.009,00
24235202AC	1.564,00
24235202OR	2.220,00
24235202LV	1.463,00
24235202LM	1.463,00

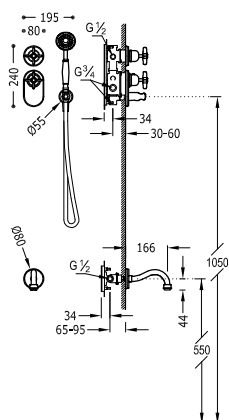
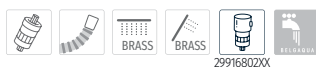

Kit de grifo termostático empotrado de 2 vías Block System para bañera y ducha

- Cuerpo empotrado termostático de instalación vertical incluido.
- Regulador de caudal y distribuidor de 2 vías.
- Caño fijo de bañera a pared.
- Soporte para ducha de mano con toma de agua a pared.
- Ducha de mano anticalcárea de latón: Ø 78 mm.
- Flexo metálico reforzado.

24235201	786,00
24235201AC	1.218,00
24235201OR	1.729,00
24235201LV	1.140,00
24235201LM	1.140,00

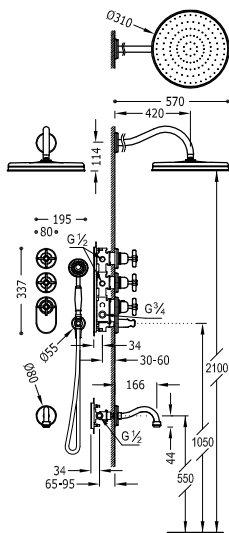
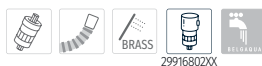

Kit de grifo termostático empotrado de 3 vías Block System para bañera y ducha

- Cuerpo empotrado termostático de instalación vertical incluido.
- Regulador de caudal y distribuidor de 3 vías.
- Brazo a pared con rociador de ducha orientable de latón: Ø 310 mm.
- Caño fijo de bañera a pared.
- Soporte para ducha de mano con toma de agua a pared.
- Ducha de mano anticalcárea de latón: Ø 78 mm.
- Flexo metálico reforzado.

24235301	1.330,00
24235301AC	2.062,00
24235301OR	2.926,00
24235301LV	1.929,00
24235301LM	1.929,00

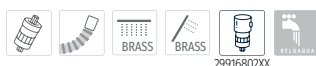

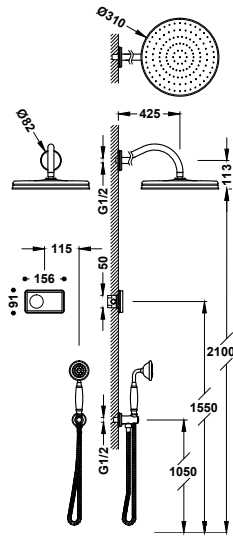

Kit de grifo termostático electrónico empotrado de 2 vías Shower technology para ducha

- Control electrónico incluido con juntas antihumedad Schlüter.
- Centralita termostática electrónica incluida de 2 vías.
- Brazo a pared con rociador de ducha orientable de latón: Ø 310 mm.
- Soporte para ducha de mano con toma de agua a pared.
- Ducha de mano anticalcárea de latón: Ø 78 mm.
- Flexo metálico reforzado.

09226201	1.176,00
09226201AC	1.640,00
09226201OR	2.158,00
09226201LV	1.624,00
09226201LM	1.624,00

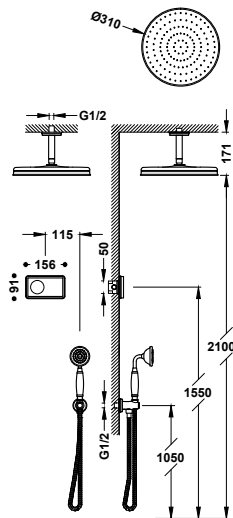
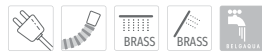

Kit de grifo termostático electrónico empotrado de 2 vías Shower technology para ducha

- Control electrónico incluido con juntas antihumedad Schlüter.
- Centralita termostática electrónica incluida de 2 vías.
- Brazo a techo con rociador de ducha orientable de latón: Ø 310 mm.
- Soporte para ducha de mano con toma de agua a pared.
- Ducha de mano anticalcárea de latón: Ø 78 mm.
- Flexo metálico reforzado.

09226202	1.213,00
09226202AC	1.596,00
09226202OR	2.095,00
09226202LV	1.589,00
09226202LM	1.589,00

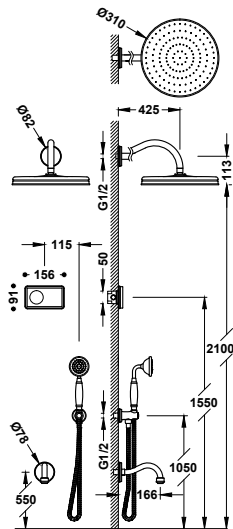
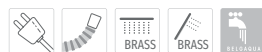

Kit de grifo termostático electrónico empotrado de 3 vías Shower technology para bañera y ducha

- Control electrónico incluido con juntas antihumedad Schlüter.
- Centralita termostática electrónica incluida de 3 vías.
- Brazo a pared con rociador de ducha orientable de latón: Ø 310 mm.
- Caño fijo de bañera a pared.
- Soporte para ducha de mano con toma de agua a pared.
- Ducha de mano anticalcárea de latón: Ø 78 mm.
- Flexo metálico reforzado.

09226301	1.383,00
09226301AC	1.834,00
09226301OR	2.422,00
09226301LV	1.805,00
09226301LM	1.805,00



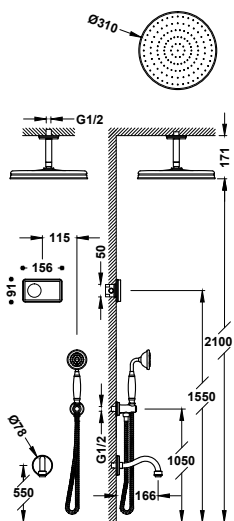

Kit de grifo termostático electrónico empotrado de 3 vías Shower technology para bañera y ducha

- Control electrónico incluido con juntas antihumedad Schlüter.
- Centralita termostática electrónica incluida de 3 vías.
- Brazo a techo con rociador de ducha orientable de latón: Ø 310 mm.
- Caño fijo de bañera a pared.
- Soporte para ducha de mano con toma de agua a pared.
- Ducha de mano anticalcárea de latón: Ø 78 mm.
- Flexo metálico reforzado.

09226302	1.355,00
09226302AC	1.791,00
09226302OR	2.340,00
09226302LV	1.770,00
09226302LM	1.770,00



GRIFOS PARA VARIOS USOS

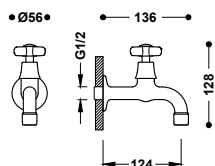

Grifo de 1 agua para office o lavadero

Con conexión roscada de G1/2.

24252001	103,00
24252001AC	159,00
24252001OR	226,00
24252001LV	149,00
24252001LM	149,00

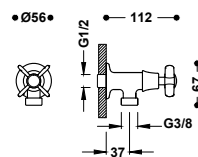

Grifo de 1 agua para lavadora

Con conexión roscada de G1/2.

24250001	88,00
24250001AC	136,00
24250001OR	193,00
24250001LV	127,00
24250001LM	127,00



LLAVES DE PASO

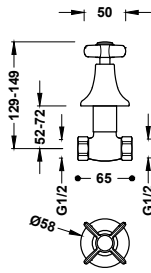

Llave de paso empotrada

Con conexión roscada de G1/2. Índice cerámico (frío).

24215501	93,00
24215501AC	145,00
24215501OR	206,00
24215501LV	136,00
24215501LM	136,00



29910501

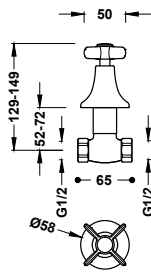

Llave de paso empotrada

Con conexión roscada de G1/2. Índice cerámico (caliente).

24215502	93,00
24215502AC	145,00
24215502OR	206,00
24215502LV	136,00
24215502LM	136,00



29910501

COMPLEMENTOS DE DUCHA

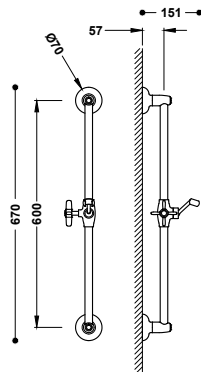

Barra deslizante para ducha

Barra de ducha: 600 mm y Ø 20,6 mm. Soporte deslizante y orientable para ducha de mano.

24273201	216,00
24273201AC	335,00
24273201LV	313,00
24273201LM	313,00

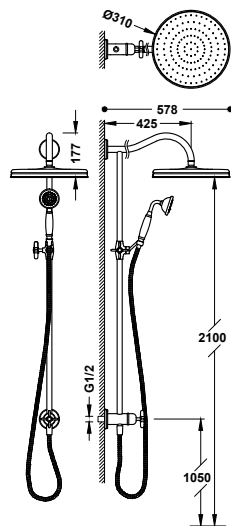

Conjunto de barra de ducha sin grifo con toma de agua a pared y rociador

- Con inversor integrado en la barra de ducha.
- Rociador de ducha orientable de latón: Ø 310 mm.
- Soporte deslizante y orientable para ducha de mano.
- Ducha de mano anticalcárea de latón: Ø 78 mm.
- Flexo metálico reforzado.

24247602	481,00
24247602AC	745,00
24247602LV	697,00
24247602LM	697,00



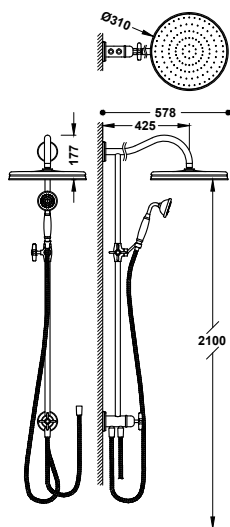

Conjunto de barra de ducha adaptable a cualquier grifo

- Con inversor integrado en la barra de ducha.
- Rociador de ducha orientable de latón: Ø 310 mm.
- Soporte deslizante y orientable para ducha de mano.
- Ducha de mano anticalcárea de latón: Ø 78 mm.
- Flexo metálico reforzado.

24247601	494,00
24247601AC	765,00
24247601LV	716,00
24247601LM	716,00

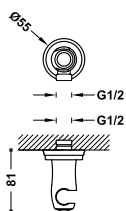

Soporte fijo con toma de agua para ducha de mano y flexo

Con toma de agua a pared.

24218201	71,00
24218201AC	111,00
24218201OR	157,00
24218201LV	104,00
24218201LM	104,00

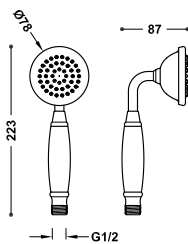

Ducha de mano Clasic

Mango cerámico. Dimensiones: Ø 78 mm. Material: Latón. Boquillas anticalcáreas.

29963109	58,00
29963109AC	90,00
29963109OR	145,00
29963109LV	84,00
29963109LM	84,00

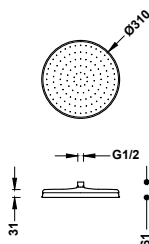

Rociador de ducha Clasic

Dimensiones: Ø 310 mm. Rótula orientable. Material: Latón. Boquillas anticalcáreas.

29933703	268,00
29933703AC	415,00
29933703OR	590,00
29933703LV	389,00
29933703LM	389,00



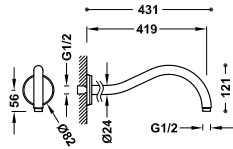

Brazo a pared Clasic

Para rociador de ducha. Longitud: 419 mm.

29933701	84,00
29933701AC	130,00
29933701OR	185,00
29933701LV	122,00
29933701LM	122,00

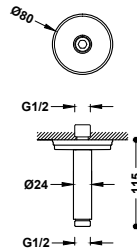

Brazo a techo Clasic

Para rociador de ducha. Longitud: 115 mm.

29933702	60,00
29933702AC	93,00
29933702OR	132,00
29933702LV	87,00
29933702LM	87,00

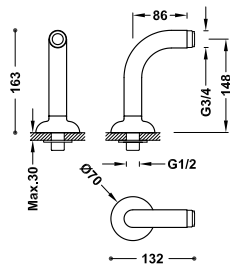

Tomas de agua acodadas de instalación a borde bañera para grifo de bañera

2 unidades con silenciador.

24287101	154,00
24287101AC	239,00
24287101OR	339,00
24287101LV	223,00
24287101LM	223,00

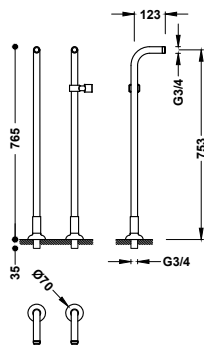

Tomas de agua acodadas de instalación a suelo para grifo de bañera

2 columnas verticales de alimentación de agua a suelo.

24219403	350,00
24219403AC	543,00
24219403OM	770,00
24219403LV	508,00
24219403LM	508,00



SLIM

Líneas estilizadas y esbeltas para una exclusividad incomparable. La finura de las piezas de la serie Slim y la elegancia de sus acabados subrayan su longitud y enfatizan un estilo único, personal y contemporáneo.

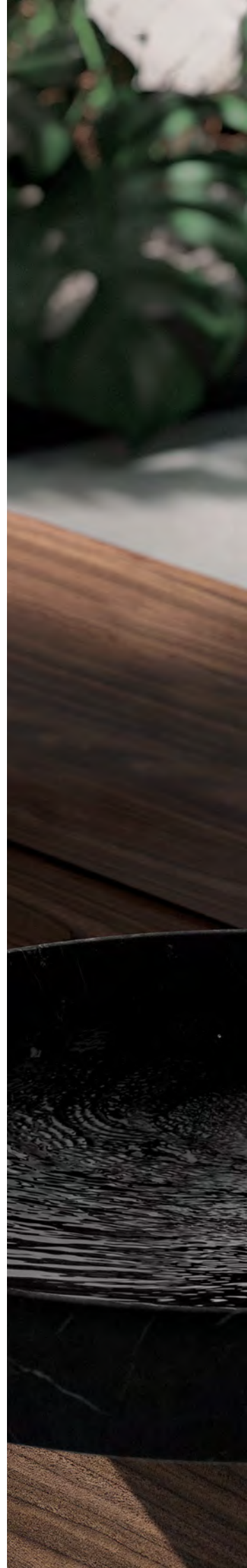





GRIFOS PARA LAVABO

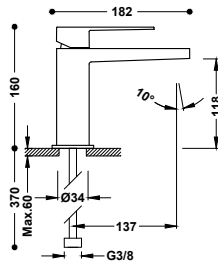

Grifo monomando para lavabo

Latiguillos de alimentación flexibles G3/8.



	20210301	193,00
	20210301D	216,00
	20210301NM	299,00
	20210301BM	299,00
	20210301AC	299,00
	20210301KMB	299,00 N
	20210301OR	425,00
	20210301OM	425,00

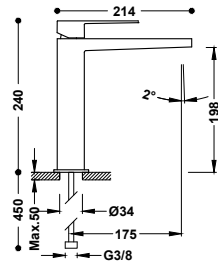

Grifo monomando alto para lavabo

Latiguillos de alimentación flexibles G3/8.



	20210303	362,00
	20210303NM	561,00
	20210303BM	561,00
	20210303AC	561,00
	20210303KMB	561,00 N
	20210303OR	797,00
	20210303OM	797,00

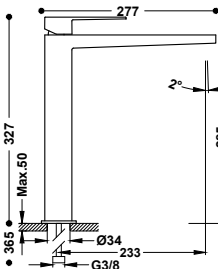

Grifo monomando XXL para lavabo

Latiguillos de alimentación flexibles G3/8.



	20210305	399,00
	20210305NM	618,00
	20210305BM	618,00
	20210305AC	618,00
	20210305KMB	618,00 N
	20210305OR	878,00
	20210305OM	878,00

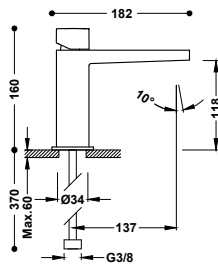

Grifo monomando para lavabo

Latiguillos de alimentación flexibles G3/8.



	20210302	193,00
	20210302D	216,00

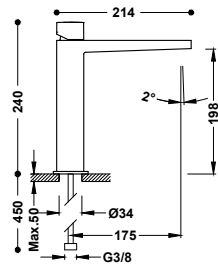

Grifo monomando alto para lavabo

Latiguillos de alimentación flexibles G3/8.



	20210304	362,00
--	----------	--------

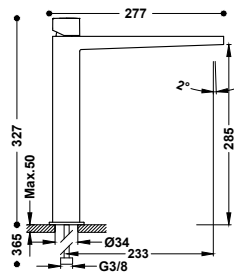

Grifo monomando XXL para lavabo
Latiguillos de alimentación flexibles G3/8.

20210306 399,00

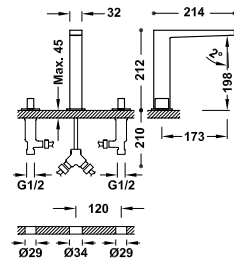

Grifo bimando de repisa para lavabo
De instalación libre. Con volantes.

20210501 389,00
20210501NM 602,00
20210501BM 602,00
20210501AC 602,00
20210501OR 855,00
20210501OM 855,00

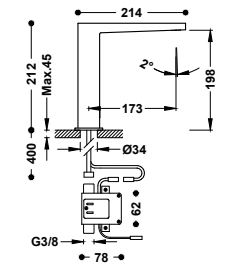

Grifo electrónico de 1 agua para lavabo
Accionado mediante sensor de infrarrojos.

20261310 357,00
20261310NM 553,00
20261310BM 553,00
20261310AC 553,00
20261310OR 785,00
20261310OM 785,00

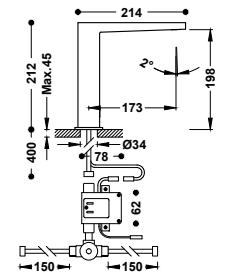

Grifo electrónico con sistema premezclador para lavabo
Accionado mediante sensor de infrarrojos. Incluye una válvula mezcladora de 2 aguas con tubos flexibles.

20261320 399,00
20261320NM 618,00
20261320BM 618,00
20261320AC 618,00
20261320OR 878,00
20261320OM 878,00



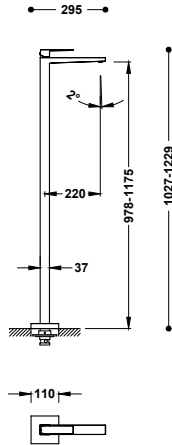

Grifo monomando con toma a suelo para lavabo

Caja empotrada (Ref. 26285350) no incluida. 1 columna vertical de alimentación de agua a suelo.

20285301	660,00
20285301NM	1.023,00
20285301BM	1.023,00
20285301AC	1.023,00
20285301KM	1.023,00
20285301KMB	1.023,00
20285301OR	1.452,00
20285301OM	1.452,00
20285301OP	1.452,00
20285301OPM	1.452,00



Base de empotramiento para montaje de grifos monomando a suelo

26285350	189,00
404	

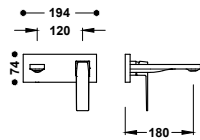

Pieza vista para cuerpo empotrado de lavabo

Solo parte vista. Incluye placa embellecedora, mando y caño de 180 mm. Cuerpo empotrado no incluido.

20230031	205,00
20230031NM	318,00
20230031BM	318,00
20230031AC	318,00
20230031KMB	318,00
20230031OR	451,00
20230031OM	451,00



Cuerpo empotrado para grifo de lavabo

20830002	85,00
----------	-------

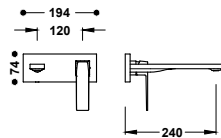

Pieza vista para cuerpo empotrado de lavabo

Solo parte vista. Incluye placa embellecedora, mando y caño de 240 mm. Cuerpo empotrado no incluido.

20230032	215,00
20230032NM	333,00
20230032BM	333,00
20230032AC	333,00
20230032KMB	333,00
20230032OR	473,00
20230032OM	473,00



Cuerpo empotrado para grifo de lavabo

20830002	85,00
----------	-------

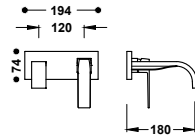

Pieza vista para cuerpo empotrado de lavabo

Solo parte vista. Incluye placa embellecedora, mando y caño de 180 mm. Cuerpo empotrado no incluido.

	20230033	220,00
	20230033NM	341,00
	20230033BM	341,00
	20230033AC	341,00
	20230033OR	484,00
	20230033OM	484,00



Cuerpo empotrado para grifo de lavabo

20830002 85,00

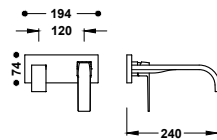

Pieza vista para cuerpo empotrado de lavabo

Solo parte vista. Incluye placa embellecedora, mando y caño de 240 mm. Cuerpo empotrado no incluido.

	20230034	240,00
	20230034NM	372,00
	20230034BM	372,00
	20230034AC	372,00
	20230034OR	528,00
	20230034OM	528,00



Cuerpo empotrado para grifo de lavabo

20830002 85,00

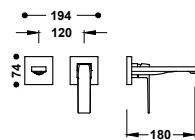

Pieza vista para cuerpo empotrado de lavabo

Solo parte vista. Incluye placa embellecedora, mando y caño de 180 mm. Cuerpo empotrado no incluido.

	20230021	170,00
	20230021NM	264,00
	20230021BM	264,00
	20230021AC	264,00
	20230021KMB	264,00
	20230021OR	374,00
	20230021OM	374,00



Cuerpo empotrado para grifo de lavabo

20830002 85,00

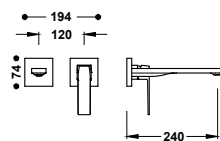

Pieza vista para cuerpo empotrado de lavabo

Solo parte vista. Incluye placa embellecedora, mando y caño de 240 mm. Cuerpo empotrado no incluido.

	20230022	180,00
	20230022NM	279,00
	20230022BM	279,00
	20230022AC	279,00
	20230022KMB	279,00
	20230022OR	396,00
	20230022OM	396,00



Cuerpo empotrado para grifo de lavabo

20830002 85,00

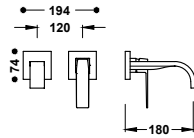

Pieza vista para cuerpo empotrado de lavabo

Solo parte vista. Incluye placa embellecedora, mando y caño de 180 mm. Cuerpo empotrado no incluido.

20230023	185,00
20230023NM	287,00
20230023BM	287,00
20230023AC	287,00
20230023OR	287,00
20230023OM	287,00



Cuerpo empotrado para grifo de lavabo

20830002 85,00

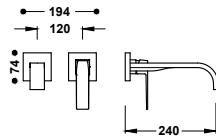

Pieza vista para cuerpo empotrado de lavabo

Solo parte vista. Incluye placa embellecedora, mando y caño de 240 mm. Cuerpo empotrado no incluido.

20230024	195,00
20230024NM	302,00
20230024BM	302,00
20230024AC	302,00
20230024OR	429,00
20230024OM	429,00



Cuerpo empotrado para grifo de lavabo

20830002 85,00

GRIFOS PARA BIDÉ

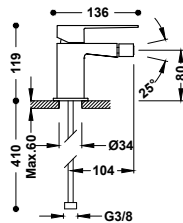

Grifo monomando para bidé

Rótula orientable. Latiguillos de alimentación flexibles G3/8.

20212001	196,00
20212001D	219,00
20212001NM	304,00
20212001BM	304,00
20212001AC	304,00
20212001KMB	304,00
20212001OR	432,00
20212001OM	432,00

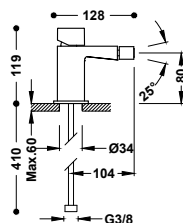

Grifo monomando para bidé

Rótula orientable. Latiguillos de alimentación flexibles G3/8.

20212002	196,00
20212002D	219,00



GRIFOS MURALES

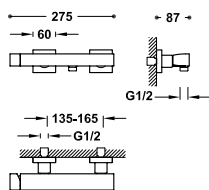

Grifo monomando mural para ducha

Ducha de mano anticalcárea de latón. Soporte orientable para ducha de mano. Flexo satinado.



20216701	344,00
20216701NM	534,00
20216701BM	534,00
20216701AC	534,00
20216701KMB	534,00 N
20216701OR	758,00
20216701OM	758,00

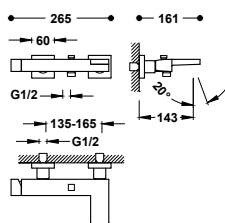

Grifo monomando mural para bañera y ducha

Ducha de mano anticalcárea de latón. Soporte orientable para ducha de mano. Flexo satinado.



20217001	365,00
20217001NM	566,00
20217001BM	566,00
20217001AC	566,00
20217001KMB	566,00 N
20217001OR	804,00
20217001OM	804,00

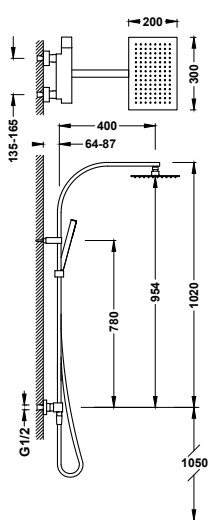

Conjunto de grifo monomando mural de 2 vías para ducha

- Rociador de ducha orientable de acero inoxidable: 300x200 mm.
- Soporte deslizante y orientable para ducha de mano.
- Ducha de mano anticalcárea de latón.
- Flexo satinado.

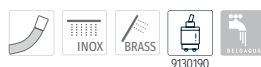

20219101	715,00
20219101NM	1.108,00
20219101BM	1.108,00
20219101AC	1.108,00
20219101KMB	1.108,00 N

GRIFOS EMPOTRADOS

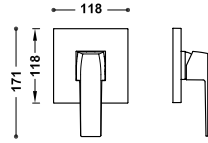

Pieza vista para caja empotrada de 1 vía Rapid-box

Sólo parte vista. Incluye placa embellecedora, mando, casquillo y tornillo de fijación oculto. Completar con la caja empotrada Rapid-box ref.: 20827810.

20227810	89,00
20227810NM	138,00
20227810BM	138,00
20227810AC	138,00
20227810KMB	138,00 N
20227810OR	196,00
20227810OM	196,00



Caja empotrada de 1 vía Rapid-box con grifo monomando para ducha

20827810	80,00
----------	-------

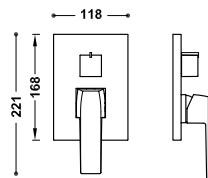

Pieza vista para caja empotrada de 2 vías Rapid-box

Sólo parte vista. Incluye placa embellecedora, mando, volante distribuidor y tornillo de fijación oculto. Completar con la caja empotrada Rapid-box ref.: 20828110.

20228110	116,00
20228110NM	179,00
20228110BM	179,00
20228110AC	179,00
20228110KMB	179,00 N
20228110OR	254,00
20228110OM	254,00



Caja empotrada de 2 vías Rapid-box con grifo monomando para ducha y bañera

20828110	90,00
----------	-------

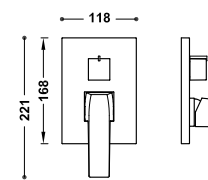

Pieza vista para caja empotrada de 3 vías Rapid-box

Sólo parte vista. Incluye placa embellecedora, mando, volante distribuidor y tornillo de fijación oculto. Completar con la caja empotrada Rapid-box ref.: 20827310.

20227310	125,00
20227310NM	194,00
20227310BM	194,00
20227310AC	194,00
20227310OR	275,00
20227310OM	275,00



Caja empotrada de 3 vías Rapid-box con grifo monomando para ducha y bañera

20827310	95,00
----------	-------

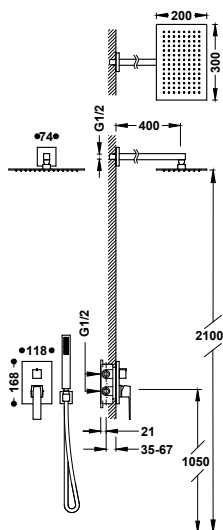

**Kit de grifo monomando empotrado de 2 vías
Rapid-box para ducha**

- Cuerpo empotrado incluido.
- Distribuidor cerámico de 2 vías.
- Brazo a pared con rociador de ducha orientable y de acero inoxidable: 300x200 mm.
- Soporte para ducha de mano con toma de agua a pared.
- Ducha de mano anticalcárea de latón.
- Flexo satinado.

20228004	595,00
20228004NM	868,00
20228004BM	868,00
20228004AC	868,00
20228004KMB	868,00
20228004OR	1.195,00
20228004OM	1.195,00

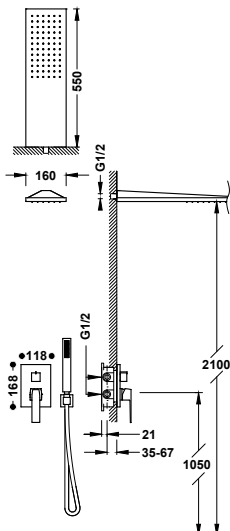
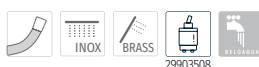

**Kit de grifo monomando empotrado de 2 vías
Rapid-box para ducha**

- Cuerpo empotrado incluido.
- Distribuidor cerámico de 2 vías.
- Rociador de ducha a pared de acero inoxidable: 160x550 mm.
- Soporte para ducha de mano con toma de agua a pared.
- Ducha de mano anticalcárea de latón.
- Flexo satinado.

20228005	750,00
20228005NM	1.108,00
20228005BM	1.108,00
20228005AC	1.108,00
20228005OR	1.537,00
20228005OM	1.537,00

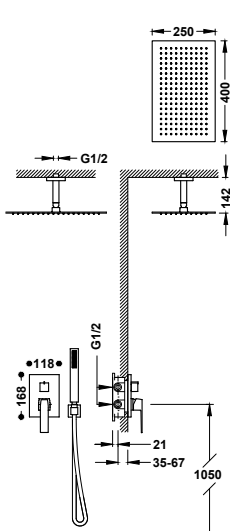
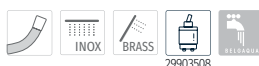

**Kit de grifo monomando empotrado de 2 vías
Rapid-box para ducha**

- Cuerpo empotrado incluido.
- Distribuidor cerámico de 2 vías.
- Brazo a techo con rociador de ducha orientable y de acero inoxidable: 400x250 mm.
- Soporte para ducha de mano con toma de agua a pared.
- Ducha de mano anticalcárea de latón.
- Flexo satinado.

20228003	621,00
20228003NM	916,00
20228003BM	916,00
20228003AC	916,00
20228003OR	1.263,00
20228003OM	1.263,00

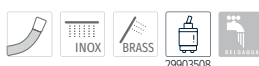

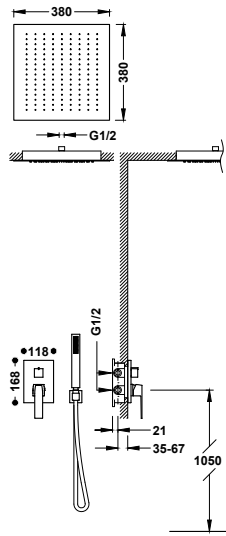

**Kit de grifo monomando empotrado de 2 vías
Rapid-box para ducha**

- Cuerpo empotrado incluido.
- Distribuidor cerámico de 2 vías.
- Rociador de ducha empotrado a techo de acero inoxidable: 380x380 mm.
- Soporte para ducha de mano con toma de agua a pared.
- Ducha de mano anticalcárea de latón.
- Flexo satinado.

20228006	1.100,00
20228006NM	1.657,00
20228006BM	1.657,00
20228006AC	1.657,00
20228006OR	2.316,00
20228006OM	2.316,00

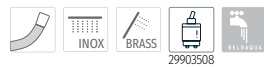

**Kit de grifo monomando empotrado de 2 vías
Rapid-box para bañera y ducha**

- Cuerpo empotrado incluido.
- Distribuidor cerámico de 2 vías.
- Caño fijo de bañera a pared.
- Soporte para ducha de mano con toma de agua a pared.
- Ducha de mano anticalcárea de latón.
- Flexo satinado.

20228007	462,00
20228007NM	651,00
20228007BM	651,00
20228007AC	651,00
20228007OR	907,00
20228007OM	907,00

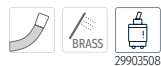
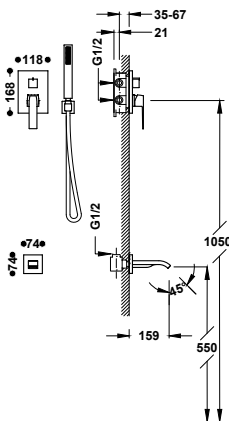

**Kit de grifo monomando empotrado de 3 vías
Rapid-box para ducha**

- Cuerpo empotrado incluido.
- Distribuidor cerámico de 3 vías.
- Rociador de ducha a pared de acero inoxidable con 2 tipos de chorro (lluvia/cascada). 280x550 mm. IMPORTANTE: Montar un desagüe de >50 l/min.
- Soporte para ducha de mano con toma de agua a pared.
- Ducha de mano anticalcárea de latón.
- Flexo satinado.

20227301	1.076,00
20227301NM	1.618,00
20227301BM	1.618,00
20227301AC	1.618,00
20227301KMB	1.618,00
20227301OR	2.258,00
20227301OM	2.258,00

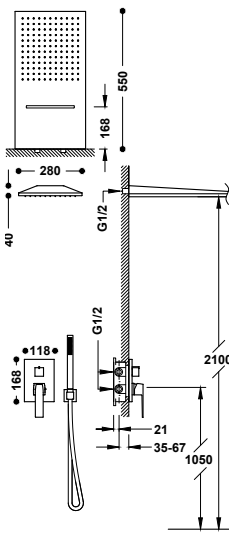

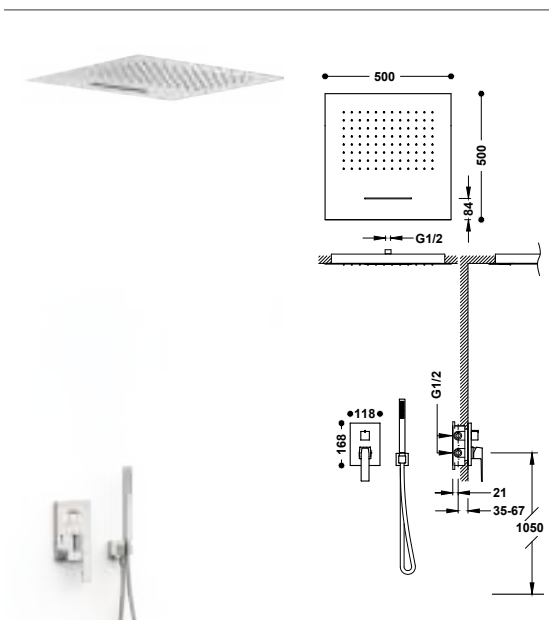

Kit de grifo monomando empotrado de 3 vías Rapid-box para ducha

- Cuerpo empotrado incluido.
- Distribuidor cerámico de 3 vías.
- Rociador de ducha empotrado a techo de acero inoxidable con 2 tipos de chorro (lluvia/cascada). 500x500 mm. IMPORTANTE: Montar un desagüe de >50 l/min.
- Soporte para ducha de mano con toma de agua a pared.
- Ducha de mano anticalcárea de latón.
- Flexo satinado.

20227302	1.445,00
20227302NM	2.189,00
20227302BM	2.189,00
20227302AC	2.189,00
20227302KMB	2.189,00
20227302OR	3.069,00
20227302OM	3.069,00

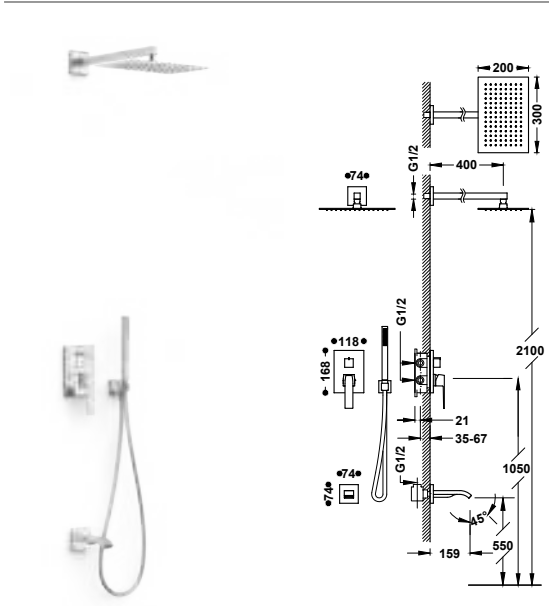

Kit de grifo monomando empotrado de 3 vías Rapid-box para ducha

- Cuerpo empotrado incluido.
- Distribuidor cerámico de 3 vías.
- Brazo a pared con rociador de ducha orientable y de acero inoxidable: 300x200 mm.
- Caño fijo de bañera a pared.
- Soporte para ducha de mano con toma de agua a pared.
- Ducha de mano anticalcárea de latón.
- Flexo satinado.

20227303	786,00
20227303NM	1.203,00
20227303BM	1.203,00
20227303AC	1.203,00
20227303OR	1.618,00
20227303OM	1.618,00



GRIFOS PARA BAÑERA

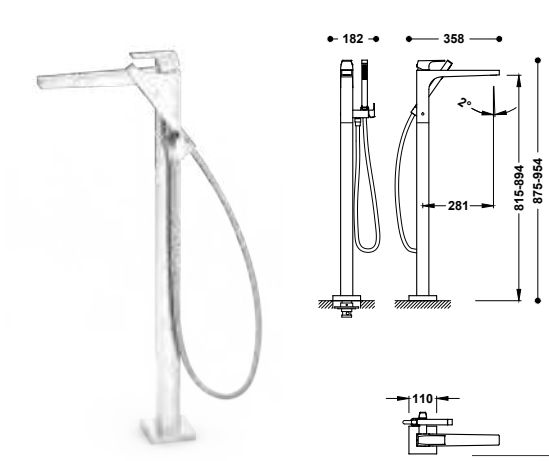

Grifo monomando a suelo para bañera y ducha

- Caja empotrada (ref. 26285350) no incluida. 1 columna vertical de alimentación de agua a suelo. Soporte para ducha de mano con cierre y regulación de caudal independiente. Ducha de mano anticalcárea de latón. Flexo satinado.

20247001	1.660,00
20247001NM	1.798,00
20247001BM	1.798,00
20247001AC	1.798,00
20247001KM	1.798,00
20247001KMB	1.798,00
20247001OR	2.552,00
20247001OM	2.552,00
20247001OP	2.552,00
20247001OPM	2.552,00

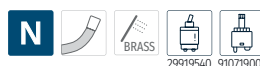

Base de empotramiento para montaje de grifos monomando a suelo

26285350	189,00
→ 404	

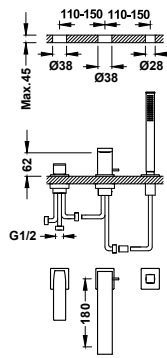

Grifo monomando para borde de bañera

- Inversor integrado en el caño de bañera.
- Ducha de mano anticalcárea de latón.
- Caño de bañera de 180 mm. Caudal: 3 bar - 13 l/m.
- Kit depósito opcional no incluido ref: 20224501.

20216103	450,00
20216103NM	698,00
20216103BM	698,00
20216103AC	698,00
20216103OR	990,00
20216103OM	990,00



Depósito para grifería de borde de bañera

20224501	415,00
----------	--------



Válvula de desagüe Click-clack para bañera con rebosadero y toma de drenaje

134445	100,00
--------	--------

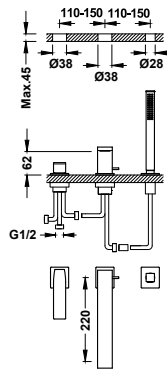

Grifo monomando para borde de bañera

- Inversor integrado en el caño de bañera.
- Ducha de mano anticalcárea de latón.
- Caño de bañera de 220 mm. Caudal: 3 bar - 13 l/m.
- Kit depósito opcional no incluido ref: 20224501.

20216101	460,00
20216101NM	713,00
20216101BM	713,00
20216101AC	713,00
20216101OR	1.012,00
20216101OM	1.012,00



Depósito para grifería de borde de bañera

20224501	415,00
----------	--------



Válvula de desagüe Click-clack para bañera con rebosadero y toma de drenaje

134445	100,00
--------	--------

GRIFOS TERMOSTÁTICOS MURALES

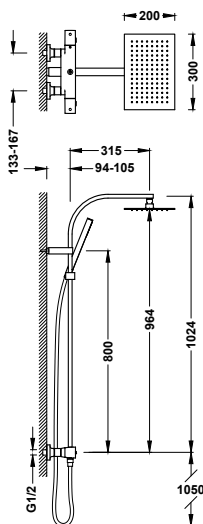

Conjunto de grifo termostático mural Over-wall de 2 vías para ducha

- Con inversor integrado en el regulador de caudal.
- Volante cuadrado.
- Rociador de ducha orientable de acero inoxidable: 300x200 mm.
- Soporte deslizante y orientable para ducha de mano.
- Ducha de mano anticalcárea de latón.
- Flexo satinado.

19039306	671,00
19039306NM	1.040,00
19039306BM	1.040,00
19039306AC	1.040,00
19039306KMB	1.040,00
19039306OM	1.476,00



GRIFOS TERMOSTÁTICOS EMPOTRADOS

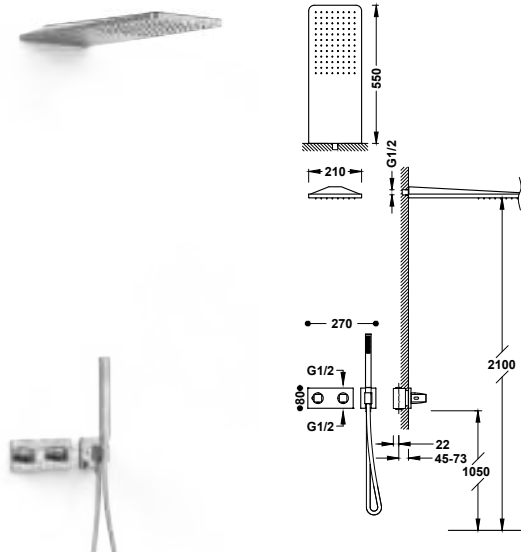

Kit de grifo termostático empotrado de 2 vías B-system para ducha

- Cuerpo empotrado termostático de instalación horizontal incluido.
- Regulador de caudal y distribuidor cerámico de 2 vías.
- Volante cuadrado-redondo.
- Rociador de ducha a pared de acero inoxidable: 210x550 mm.
- Soporte para ducha de mano con toma de agua a pared.
- Ducha de mano anticalcárea de latón.
- Flexo satinado.

30725205	1.116,00
30725205NM	1.730,00
30725205AC	1.730,00
30725205KMB	1.730,00 N
30725205OR	2.456,00
30725205OM	2.456,00
30725205OP	2.456,00
30725205OPM	2.456,00

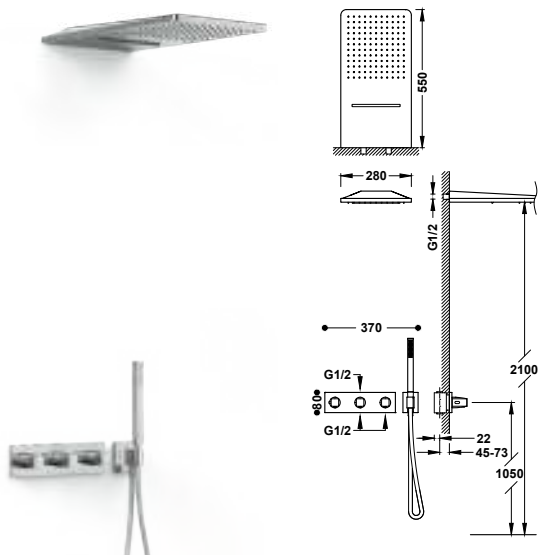

Kit de grifo termostático empotrado de 3 vías B-system para ducha

- Cuerpo empotrado termostático de instalación horizontal incluido.
- Regulador de caudal y distribuidor de 3 vías.
- Volante cuadrado-redondo.
- Rociador de ducha a pared de acero inoxidable con 2 tipos de chorro (lluvia/cascada). 280x550 mm. IMPORTANTE: Montar un desagüe de >50 l/min.
- Soporte para ducha de mano con toma de agua a pared.
- Ducha de mano anticalcárea de latón.
- Flexo satinado.

30725305	1.410,00
30725305NM	2.172,00
30725305AC	2.172,00
30725305KMB	2.172,00 N
30725305OR	3.083,00
30725305OM	3.083,00
30725305OP	3.083,00
30725305OPM	3.083,00

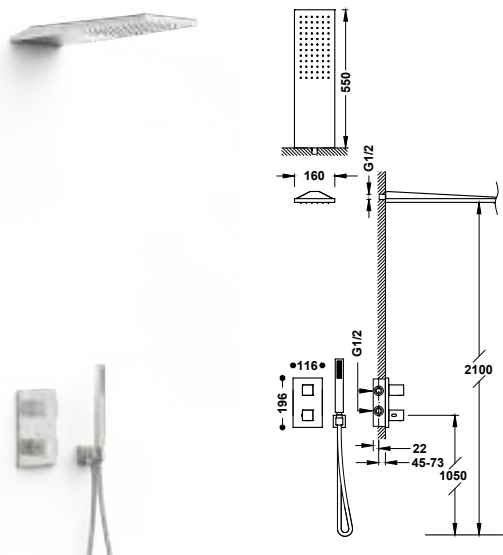

Kit de grifo termostático empotrado de 2 vías Therm-box para ducha

- Cuerpo empotrado incluido.
- Volante cuadrado con control de temperatura. Distribuidor cerámico de 2 vías.
- Rociador de ducha a pared de acero inoxidable: 160x550 mm.
- Soporte para ducha de mano con toma de agua a pared.
- Ducha de mano anticalcárea de latón.
- Flexo satinado.

20225055	829,00
20225055NM	1.216,00
20225055BM	1.216,00
20225055AC	1.216,00
20225055KMB	1.216,00 N
20225055OR	1.672,00
20225055OM	1.672,00



EXCLUSIVE COLLECTIONS



STUDY

Simple a la vez que extravagante. Los cuerpos cilíndricos y delgados de Study aspiran al equilibrio atemporal. Un diseño minimalista y armonioso con acabados metálicos que sorprenden.

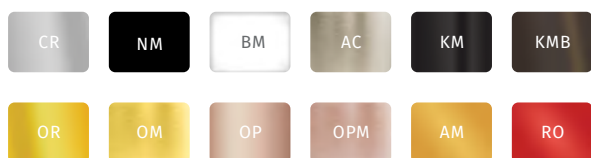





GRIFOS PARA LAVABO

Grifo monomando para lavabo

Latiguillos de alimentación flexibles G3/8.

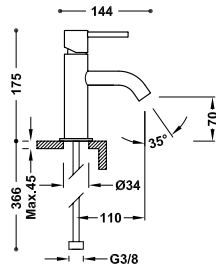

26290301	173,00
26290301D	196,00
26290301NM	269,00
26290301BM	269,00
26290301AC	269,00
26290301KM	269,00
26290301KMB	269,00
26290301OR	381,00
26290301OM	381,00
26290301OP	381,00
26290301OPM	381,00
26290301TAM	269,00
26290301TRO	269,00

Grifo monomando alto para lavabo

Latiguillos de alimentación flexibles G3/8.

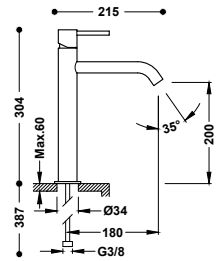

26230701	312,00
26230701NM	483,00
26230701BM	483,00
26230701AC	483,00
26230701KM	483,00
26230701KMB	483,00
26230701OR	686,00
26230701OM	686,00
26230701OP	686,00
26230701OPM	686,00
26230701TAM	483,00
26230701TRO	483,00

Grifo monomando XXL para lavabo

Latiguillos de alimentación flexibles G3/8.

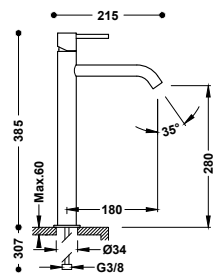

26230801	341,00
26230801NM	529,00
26230801BM	529,00
26230801AC	529,00
26230801KM	529,00
26230801KMB	529,00
26230801OR	751,00
26230801OM	751,00
26230801OP	751,00
26230801OPM	751,00
26230801TAM	529,00
26230801TRO	529,00

Grifo monomando para lavabo

Latiguillos de alimentación flexibles G3/8.

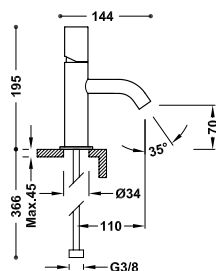

26190301	173,00
26190301D	196,00
26190301NM	269,00
26190301BM	269,00
26190301AC	269,00
26190301KM	269,00
26190301KMB	269,00
26190301OR	381,00
26190301OM	381,00
26190301OP	381,00
26190301OPM	381,00
26190301TAM	269,00
26190301TRO	269,00

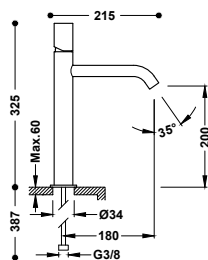

Grifo monomando alto para lavabo
Latiguillos de alimentación flexibles G3/8.



910719005

26130701	312,00
26130701NM	483,00
26130701BM	483,00
26130701AC	483,00
26130701KM	483,00
26130701KMB	483,00
26130701OR	686,00
26130701OM	686,00
26130701OP	686,00
26130701OPM	686,00
26130701TAM	483,00
26130701TRO	483,00

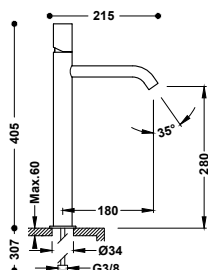

Grifo monomando XXL para lavabo
Latiguillos de alimentación flexibles G3/8.



910719005

26130801	341,00
26130801NM	529,00
26130801BM	529,00
26130801AC	529,00
26130801KM	529,00
26130801KMB	529,00
26130801OR	751,00
26130801OM	751,00
26130801OP	751,00
26130801OPM	751,00
26130801TAM	529,00
26130801TRO	529,00

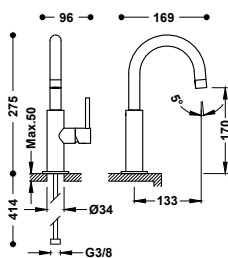

Grifo monomando con maneta lateral para lavabo
Latiguillos de alimentación flexibles G3/8.



9130190

26290403	221,00
26290403NM	342,00
26290403BM	342,00
26290403AC	342,00
26290403KM	342,00
26290403KMB	342,00
26290403OR	485,00
26290403OM	485,00
26290403OP	485,00
26290403OPM	485,00
26290403TAM	342,00
26290403TRO	342,00

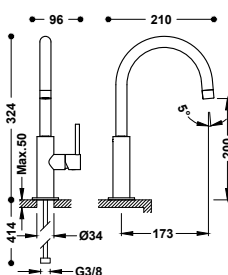

Grifo monomando alto con maneta lateral para lavabo
Latiguillos de alimentación flexibles G3/8.



9130190

26290402	231,00
26290402NM	358,00
26290402BM	358,00
26290402AC	358,00
26290402KM	358,00
26290402KMB	358,00
26290402OR	508,00
26290402OM	508,00
26290402OP	508,00
26290402OPM	508,00
26290402TAM	358,00
26290402TRO	358,00

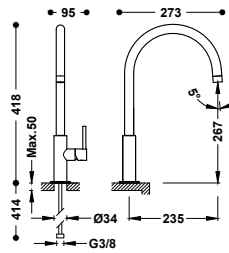

Grifo monomando XXL con maneta lateral para lavabo
Latiguillos de alimentación flexibles G3/8.



26290401	242,00
26290401NM	374,00
26290401BM	374,00
26290401AC	374,00
26290401KM	374,00
26290401KMB	374,00
26290401OR	531,00
26290401OM	531,00
26290401OP	531,00
26290401OPM	531,00
26290401TAM	374,00
26290401TRO	374,00

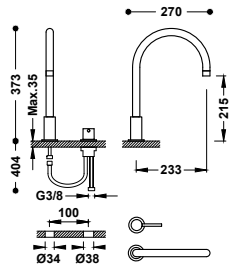

Grifo monomando de repisa para lavabo
De instalación libre.



26110501	236,00
26110501NM	366,00
26110501BM	366,00
26110501AC	366,00
26110501KM	366,00
26110501KMB	366,00
26110501OR	520,00
26110501OM	520,00
26110501OP	520,00
26110501OPM	520,00

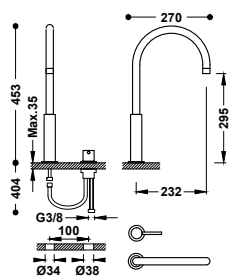

Grifo monomando alto de repisa para lavabo
De instalación libre.



26110502	252,00
26110502NM	391,00
26110502BM	391,00
26110502AC	391,00
26110502KM	391,00
26110502KMB	391,00
26110502OR	554,00
26110502OM	554,00
26110502OP	554,00
26110502OPM	554,00

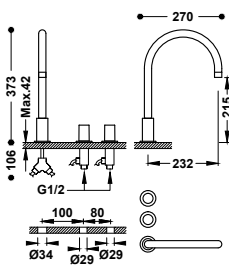

Grifo bimando de repisa para lavabo
De instalación libre. Con volantes.



06110501	278,00
06110501NM	431,00
06110501BM	431,00
06110501AC	431,00
06110501KM	431,00
06110501KMB	431,00
06110501OR	612,00
06110501OM	612,00
06110501OP	612,00
06110501OPM	612,00

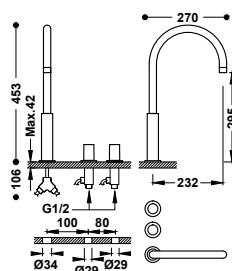

Grifo bimando alto de repisa para lavabo

De instalación libre. Con volantes.



06110502	294,00
06110502NM	456,00
06110502BM	456,00
06110502AC	456,00
06110502KM	456,00
06110502KMB	456,00
06110502OR	647,00
06110502OM	647,00
06110502OP	647,00
06110502OPM	647,00

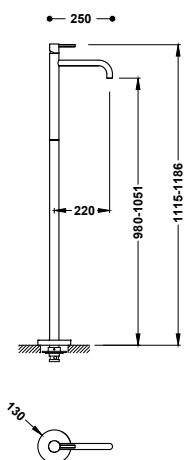

Grifo monomando con toma a suelo para lavabo

Caja empotrada (Ref. 26285350) no incluida. 1 columna vertical de alimentación de agua a suelo.



26285305	578,00
26285305NM	895,00
26285305BM	895,00
26285305AC	895,00
26285305KM	895,00
26285305KMB	895,00
26285305OR	1.271,00
26285305OM	1.271,00
26285305OP	1.271,00
26285305OPM	1.271,00



Base de empotramiento para montaje de grifos monomando a suelo

26285350	189,00
→404	

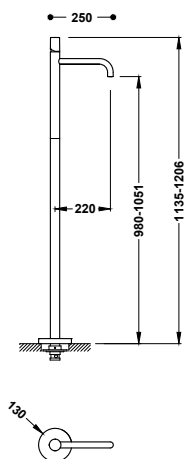

Grifo monomando con toma a suelo para lavabo

Caja empotrada (Ref. 26285350) no incluida. 1 columna vertical de alimentación de agua a suelo.



26285306	578,00
26285306NM	895,00
26285306BM	895,00
26285306AC	895,00
26285306KM	895,00
26285306KMB	895,00
26285306OR	1.271,00
26285306OM	1.271,00
26285306OP	1.271,00
26285306OPM	1.271,00



Base de empotramiento para montaje de grifos monomando a suelo

26285350	189,00
→404	

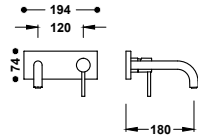

Pieza vista para cuerpo empotrado de lavabo

Solo parte vista. Incluye placa embellecedora, mando y caño de 180 mm. Cuerpo empotrado no incluido.



26230031	215,00
26230031NM	333,00
26230031BM	333,00
26230031AC	333,00
26230031KM	333,00
26230031KMB	333,00
26230031OR	473,00
26230031OM	473,00
26230031OP	473,00
26230031OPM	473,00



Cuerpo empotrado para grifo de lavabo

20830002 85,00

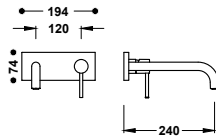

Pieza vista para cuerpo empotrado de lavabo

Solo parte vista. Incluye placa embellecedora, mando y caño de 240 mm. Cuerpo empotrado no incluido.



26230032	225,00
26230032NM	349,00
26230032BM	349,00
26230032AC	349,00
26230032KM	349,00
26230032KMB	349,00
26230032OR	450,00
26230032OM	495,00
26230032OP	495,00
26230032OPM	495,00



Cuerpo empotrado para grifo de lavabo

20830002 85,00

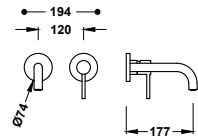

Pieza vista para cuerpo empotrado de lavabo

Solo parte vista. Incluye placa embellecedora, mando y caño de 177 mm. Cuerpo empotrado no incluido.



26230021	177,00
26230021NM	274,00
26230021BM	274,00
26230021AC	274,00
26230021KM	274,00
26230021KMB	274,00
26230021OR	389,00
26230021OM	389,00
26230021OP	389,00
26230021OPM	389,00



Cuerpo empotrado para grifo de lavabo

20830002 85,00

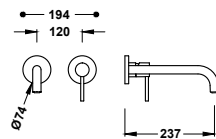

Pieza vista para cuerpo empotrado de lavabo

Solo parte vista. Incluye placa embellecedora, mando y caño de 237 mm. Cuerpo empotrado no incluido.



26230022	187,00
26230022NM	290,00
26230022BM	290,00
26230022AC	290,00
26230022KM	290,00
26230022KMB	290,00
26230022OR	411,00
26230022OM	411,00
26230022OP	411,00
26230022OPM	411,00



Cuerpo empotrado para grifo de lavabo

20830002 85,00

GRIFOS PARA BIDÉ

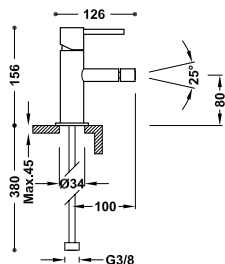

Grifo monomando para bidé

Rótula orientable. Latiguillos de alimentación flexibles G3/8.



26212001	176,00
26212001D	200,00
06212001NM	273,00
06212001BM	273,00
06212001AC	273,00
06212001KM	273,00
06212001KMB	273,00
06212001OR	388,00
06212001OM	388,00
06212001OP	388,00
06212001OPM	388,00
06212001TAM	273,00
06212001TRO	273,00

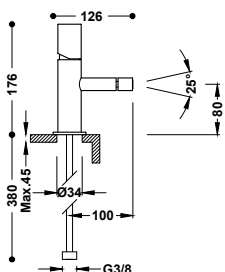

Grifo monomando para bidé

Rótula orientable. Latiguillos de alimentación flexibles G3/8.

26112001	176,00
26112001D	200,00
06112001NM	273,00
06112001BM	273,00
06112001AC	174,00
06112001KM	273,00
06112001KMB	273,00
06112001OR	388,00
06112001OM	388,00
06112001OP	388,00
06112001OPM	388,00
06112001TAM	273,00
06112001TRO	273,00

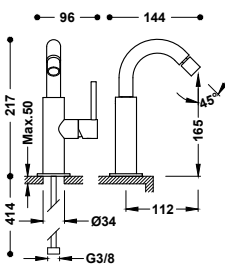

Grifo monomando con maneta lateral para bidé

Rótula orientable. Latiguillos de alimentación flexibles G3/8.

26222402	221,00
26222402NM	342,00
26222402BM	342,00
26222402AC	342,00
26222402KM	342,00
26222402KMB	342,00
26222402OR	485,00
26222402OM	485,00
26222402OP	485,00
26222402OPM	485,00
26222402TAM	342,00
26222402TRO	342,00

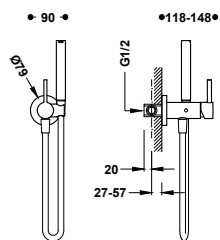

Grifo monomando empotrado con ducha para inodoro

Con agua fría y caliente. Ducha de mano con racor limitador a 5 l/min. y sistema antigoteo. Soporte fijo para la ducha de mano instalable a derecha o izquierda. Flexo satinado.

134123	190,00
134123NM	295,00
134123BM	295,00
134123AC	295,00
134123KM	295,00
134123KMB	295,00
134123OR	418,00
134123OM	418,00
134123OP	418,00
134123OPM	418,00

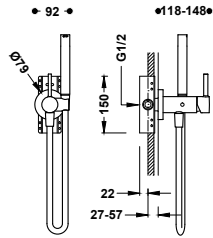

Grifo monomando empotrado con ducha para inodoro
 Opción para paredes de Pladur. Con agua fría y caliente. Ducha de mano con racor limitador a 5 l/min. y sistema antigoteo. Soporte fijo para la ducha de mano instalable a derecha o izquierda. Flexo satinado.

■	134122	230,00
■	134122NM	357,00
■	134122BM	357,00
■	134122AC	357,00

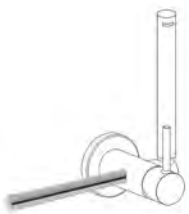

Accesorio porta toallas para grifo con ducha para inodoro

Soporte instalable a derecha o izquierda (para ref.: 134122, 134123, 181122, 181123, 181222, 181223, 20522201, 20522301). Long: 180 mm.

■	03412401	37,00
■	03412401NM	57,00
■	03412401BM	57,00
■	03412401AC	57,00
■	03412401KM	57,00
■	03412401KMB	57,00
■	03412401OR	81,00
■	03412401OM	81,00
■	03412401OP	81,00
■	03412401OPM	81,00

GRIFOS MURALES

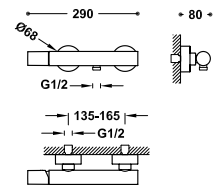

Grifo monomando mural para ducha

Ducha de mano anticalcárea. Soporte orientable para ducha de mano. Flexo satinado.

■	26116701	278,00
■	26116701NM	431,00
■	26116701BM	431,00
■	26116701AC	431,00
■	26116701KM	431,00
■	26116701KMB	431,00
■	26116701OR	612,00
■	26116701OM	612,00
■	26116701OP	612,00
■	26116701OPM	612,00
■	26116701TAM	431,00
■	26116701TRO	431,00

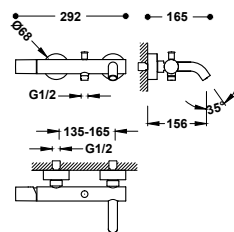

Grifo monomando mural para bañera y ducha

Ducha de mano anticalcárea. Soporte orientable para ducha de mano. Flexo satinado.

■	26117001	299,00
■	26117001NM	464,00
■	26117001BM	464,00
■	26117001AC	464,00
■	26117001KM	464,00
■	26117001KMB	464,00
■	26117001OR	658,00
■	26117001OM	658,00
■	26117001OP	658,00
■	26117001OPM	658,00
■	26117001TAM	464,00
■	26117001TRO	464,00



GRIFOS EMPOTRADOS

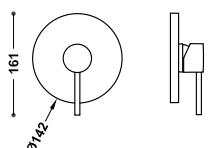

Pieza vista para caja empotrada de 1 vía Rapid-box

Sólo parte vista. Incluye placa embellecedora, mando, casquillo y tornillo de fijación oculto. Completar con la caja empotrada Rapid-box ref.: 20827810.

26227810	89,00
26227810NM	138,00
26227810BM	138,00
26227810AC	138,00
26227810KM	138,00
26227810KMB	138,00
26227810OR	196,00
26227810OM	196,00
26227810OP	196,00
26227810OPM	196,00



Caja empotrada de 1 vía Rapid-box con grifo monomando para ducha

20827810	80,00
----------	-------

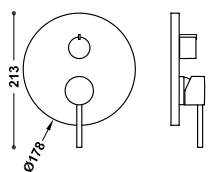

Pieza vista para caja empotrada de 2 vías Rapid-box

Sólo parte vista. Incluye placa embellecedora, mando, volante distribuidor y tornillo de fijación oculto. Completar con la caja empotrada Rapid-box ref.: 20828110.

26228110	116,00
26228110NM	179,00
26228110BM	179,00
26228110AC	179,00
26228110KM	179,00
26228110KMB	179,00
26228110OR	254,00
26228110OM	254,00
26228110OP	254,00
26228110OPM	254,00



Caja empotrada de 2 vías Rapid-box con grifo monomando para ducha y bañera

20828110	90,00
----------	-------

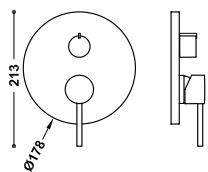

Pieza vista para caja empotrada de 3 vías Rapid-box

Sólo parte vista. Incluye placa embellecedora, mando, volante distribuidor y tornillo de fijación oculto. Completar con la caja empotrada Rapid-box ref.: 20827310.

26227310	125,00
26227310NM	194,00
26227310BM	194,00
26227310AC	194,00
26227310KM	194,00
26227310KMB	194,00
26227310OR	275,00
26227310OP	275,00
26227310OM	275,00
26227310OPM	275,00



Caja empotrada de 3 vías Rapid-box con grifo monomando para ducha y bañera

20827310	95,00
----------	-------

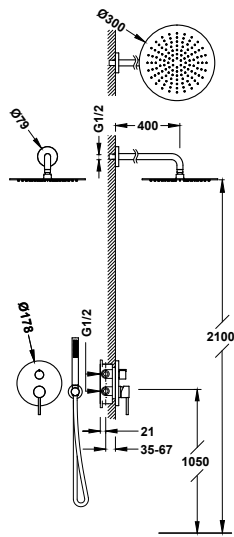

**Kit de grifo monomando empotrado de 2 vías
Rapid-box para ducha**

- Cuerpo empotrado incluido.
- Distribuidor cerámico de 2 vías.
- Brazo a pared con rociador de ducha orientable y de acero inoxidable: Ø 300 mm.
- Soporte para ducha de mano con toma de agua a pared.
- Ducha de mano anticalcárea de latón.
- Flexo satinado.

26228004	495,00
26228004NM	712,00
26228004BM	712,00
26228004AC	712,00
26228004KM	712,00
26228004KMB	712,00
26228004OR	977,00
26228004OM	977,00
26228004OP	977,00
26228004OPM	977,00

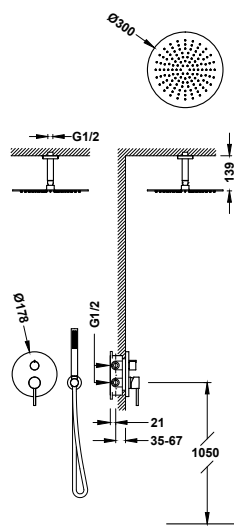

**Kit de grifo monomando empotrado de 2 vías
Rapid-box para ducha**

- Cuerpo empotrado incluido.
- Distribuidor cerámico de 2 vías.
- Brazo a techo con rociador de ducha orientable y de acero inoxidable: Ø 300 mm.
- Soporte para ducha de mano con toma de agua a pared.
- Ducha de mano anticalcárea de latón.
- Flexo satinado.

26228003	473,00
26228003NM	675,00
26228003BM	675,00
26228003AC	675,00
26228003KM	675,00
26228003KMB	675,00
26228003OR	924,00
26228003OM	924,00
26228003OP	924,00
26228003OPM	924,00

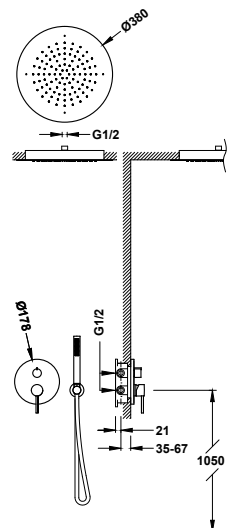

**Kit de grifo monomando empotrado de 2 vías
Rapid-box para ducha**

- Cuerpo empotrado incluido.
- Distribuidor cerámico de 2 vías.
- Rociador de ducha empotrado a techo de acero inoxidable: Ø 380 mm.
- Soporte para ducha de mano con toma de agua a pared.
- Ducha de mano anticalcárea de latón.
- Flexo satinado.

26228005	1.026,00
26228005NM	1.546,00
26228005BM	1.546,00
26228005AC	1.546,00
26228005KM	1.546,00
26228005KMB	1.546,00
26228005OR	2.160,00
26228005OM	2.160,00
26228005OP	2.160,00
26228005OPM	2.160,00



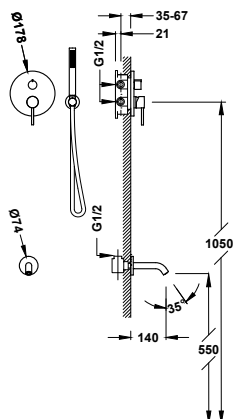

**Kit de grifo monomando empotrado de 2 vías
Rapid-box para bañera y ducha**

- Cuerpo empotrado incluido.
- Distribuidor cerámico de 2 vías.
- Caño fijo de bañera a pared.
- Soporte para ducha de mano con toma de agua a pared.
- Ducha de mano anticalcárea de latón.
- Flexo satinado.



26228006	381,00
26228006NM	545,00
26228006BM	545,00
26228006AC	545,00
26228006KM	545,00
26228006KMB	545,00
26228006OR	740,00
26228006OM	740,00
26228006OP	740,00
26228006OPM	740,00

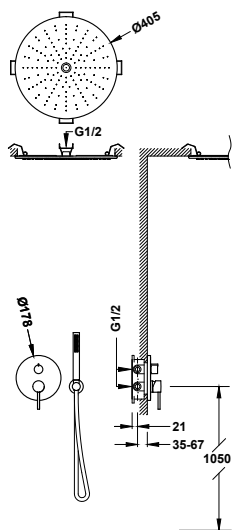

**Kit de grifo monomando empotrado de 3 vías
Rapid-box para ducha**

- Cuerpo empotrado incluido.
- Distribuidor cerámico de 3 vías.
- Rociador de ducha empotrado a techo de acero inoxidable con 2 tipos de chorro (lluvia/free flow). Ø 405 mm.
- Soporte para ducha de mano con toma de agua a pared.
- Ducha de mano anticalcárea de latón.
- Flexo satinado.



26227301	1.164,00
26227301NM	1.754,00
26227301BM	1.754,00
26227301AC	1.754,00
26227301KM	1.754,00
26227301KMB	1.754,00
26227301OR	2.450,00
26227301OP	2.450,00
26227301OM	2.450,00
26227301OPM	2.450,00

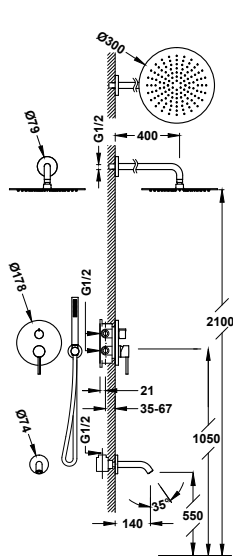

**Kit de grifo monomando empotrado de 3 vías
Rapid-box para ducha**

- Cuerpo empotrado incluido.
- Distribuidor cerámico de 3 vías.
- Brazo a pared con rociador de ducha orientable y de acero inoxidable: Ø 300 mm.
- Caño fijo de bañera a pared.
- Soporte para ducha de mano con toma de agua a pared.
- Ducha de mano anticalcárea de latón.
- Flexo satinado.



26227302	663,00
26227302NM	946,00
26227302BM	946,00
26227302AC	946,00
26227302KM	946,00
26227302KMB	946,00
26227302OR	1.304,00
26227302OP	1.304,00
26227302OM	1.304,00
26227302OPM	1.304,00

GRIFOS PARA BAÑERA

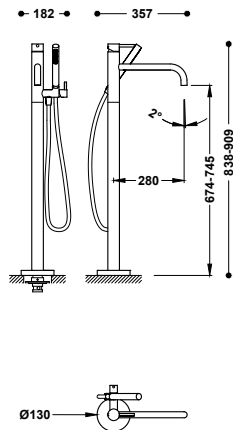

Grifo monomando a suelo para bañera y ducha

Caja empotrada (ref. 26285350) no incluida. 1 columna vertical de alimentación de agua a suelo. Soporte para ducha de mano con cierre y regulación de caudal independiente. Ducha de mano anticalcárea de latón. Flexo satinado.

26247005	1.103,00
26247005NM	1.709,00
26247005BM	1.709,00
26247005AC	1.709,00
26247005KM	1.709,00
26247005KMB	1.709,00
26247005OR	2.426,00
26247005OM	2.426,00
26247005OP	2.426,00
26247005OPM	2.426,00

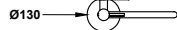

Base de empotramiento para montaje de grifos monomando a suelo

26285350	189,00
→ 404	

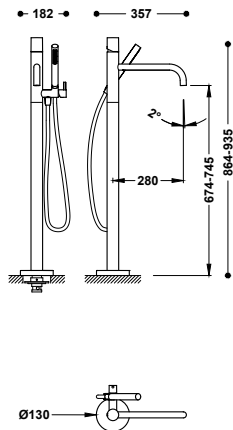

Grifo monomando a suelo para bañera y ducha

Caja empotrada (ref. 26285350) no incluida. 1 columna vertical de alimentación de agua a suelo. Soporte para ducha de mano con cierre y regulación de caudal independiente. Ducha de mano anticalcárea de latón. Flexo satinado.

26247006	1.103,00
26247006NM	1.709,00
26247006BM	1.709,00
26247006AC	1.709,00
26247006KM	1.709,00
26247006KMB	1.709,00
26247006OR	2.426,00
26247006OM	2.426,00
26247006OP	2.426,00
26247006OPM	2.426,00

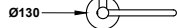

Base de empotramiento para montaje de grifos monomando a suelo

26285350	189,00
→ 404	

GRIFOS TERMOSTÁTICOS MURALES

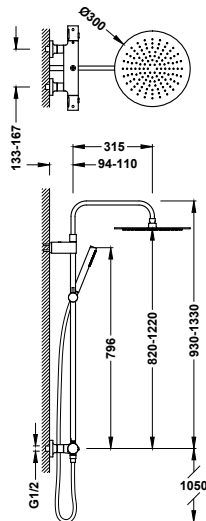

Conjunto de grifo termostático mural Over-wall de 2 vías para ducha

- Con inversor integrado en el regulador de caudal.
- Volante redondo.
- Barra de ducha telescópica.
- Rociador de ducha orientable de acero inoxidable: Ø 300 mm.
- Soporte deslizante y orientable para ducha de mano.
- Ducha de mano anticalcárea de latón.
- Flexo satinado.

19039302	559,00
19039302NM	866,00
19039302BM	866,00
19039302AC	866,00
19039302KMB	866,00
19039302OM	1.230,00
19039302OPM	1.230,00



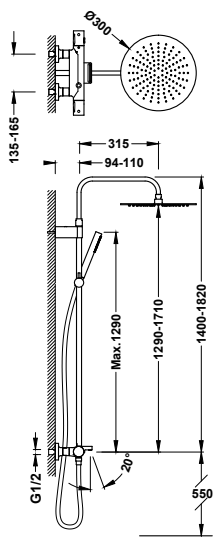

Conjunto de grifo termostático mural Over-wall de 3 vías para bañera y ducha

- Con inversor integrado en el regulador de caudal.
- Volante redondo.
- Barra de ducha telescópica.
- Rociador de ducha orientable de acero inoxidable: Ø 300 mm.
- Soporte deslizante y orientable para ducha de mano.
- Ducha de mano anticalcárea de latón.
- Flexo satinado.

19031212	654,00
19031212NM	1.014,00
19031212BM	1.014,00
19031212AC	1.014,00
19031212KMB	1.014,00
19031212OM	1.439,00
19031212OPM	1.439,00

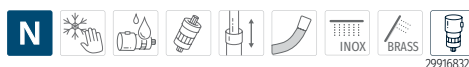

GRIFOS TERMOSTÁTICOS EMPOTRADOS

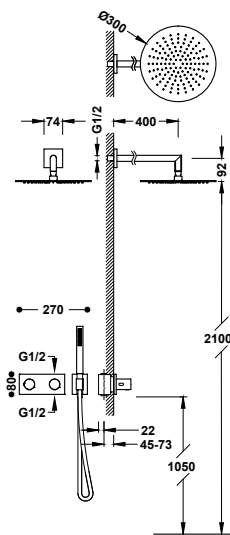

Kit de grifo termostático empotrado de 2 vías B-system para ducha

- Cuerpo empotrado termostático de instalación horizontal incluido.
- Regulador de caudal y distribuidor cerámico de 2 vías.
- Volante redondo.
- Brazo a pared con rociador de ducha orientable y de acero inoxidable: Ø 300 mm.
- Soporte para ducha de mano con toma de agua a pared.
- Ducha de mano anticalcárea de latón.
- Flexo satinado.

30735204	811,00
30735204NM	1.163,00
30735204AC	1.163,00
30735204OR	1.651,00
30735204OM	1.651,00
30735204OP	1.651,00
30735204OPM	1.651,00

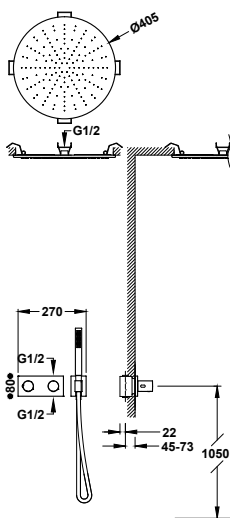

Kit de grifo termostático empotrado de 2 vías B-system para ducha

- Cuerpo empotrado termostático de instalación horizontal incluido.
- Regulador de caudal y distribuidor cerámico de 2 vías.
- Volante redondo.
- Rociador de ducha empotrado a techo de acero inoxidable: Ø 405 mm.
- Soporte para ducha de mano con toma de agua a pared.
- Ducha de mano anticalcárea de latón.
- Flexo satinado.

30735206	1.329,00
30735206NM	1.966,00
30735206AC	1.966,00
30735206OR	2.790,00
30735206OM	2.790,00
30735206OP	2.790,00
30735206OPM	2.790,00



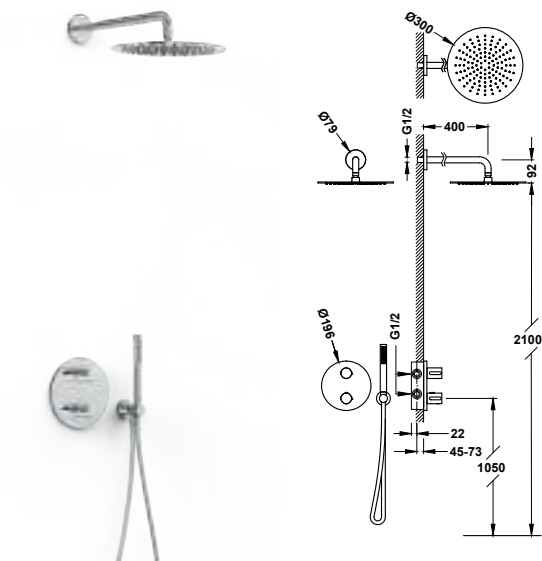

**Kit de grifo termostático empotrado de 2 vías
Therm-box para ducha**

- Cuerpo empotrado incluido.
- Volante redondo con control de temperatura. Distribuidor cerámico de 2 vías.
- Brazo a pared con rociador de ducha orientable y de acero inoxidable: Ø 300 mm.
- Soporte para ducha de mano con toma de agua a pared.
- Ducha de mano anticalcárea de latón.
- Flexo satinado.

26225004	585,00
26225004NM	837,00
26225004BM	837,00
26225004AC	837,00
26225004KM	837,00
26225004KMB	837,00
26225004OR	1.136,00
26225004OM	1.136,00
26225004OP	1.136,00
26225004OPM	1.136,00

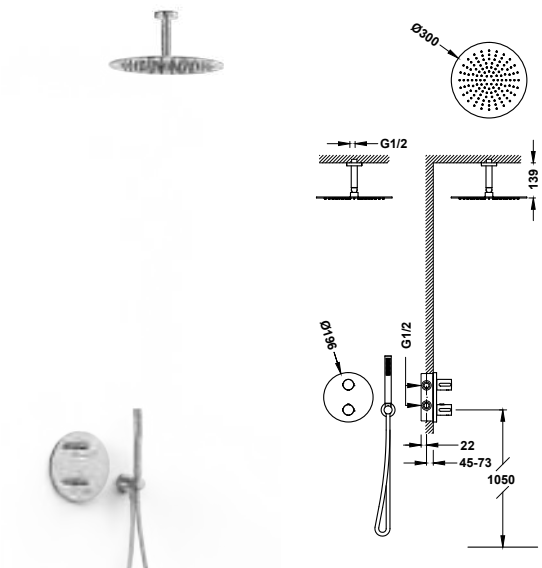

**Kit de grifo termostático empotrado de 2 vías
Therm-box para ducha**

- Cuerpo empotrado incluido.
- Volante redondo con control de temperatura. Distribuidor cerámico de 2 vías.
- Brazo a techo con rociador de ducha orientable y de acero inoxidable: Ø 300 mm.
- Soporte para ducha de mano con toma de agua a pared.
- Ducha de mano anticalcárea de latón.
- Flexo satinado.

26225003	558,00
26225003NM	797,00
26225003BM	797,00
26225003AC	797,00
26225003KM	797,00
26225003KMB	797,00
26225003OR	1.078,00
26225003OM	1.078,00
26225003OP	1.078,00
26225003OPM	1.078,00



LLAVES DE PASO



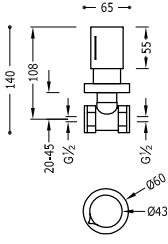

Llave de paso empotrada
Conexión a rosca hembra: 1/2".

06115501	83,00
06115501NM	128,00
06115501BM	128,00
06115501AC	128,00
06115501KM	128,00
06115501KMB	128,00
06115501OR	182,00
06115501OM	182,00
06115501OP	182,00
06115501OPM	182,00



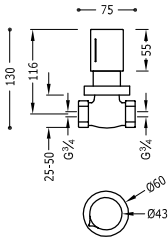

Llave de paso empotrada
Conexión a rosca hembra: 3/4".

06151101	91,00
06151101NM	140,00
06151101BM	140,00
06151101AC	140,00
06151101KM	140,00
06151101KMB	140,00
06151101OR	199,00
06151101OM	199,00
06151101OP	199,00
06151101OPM	199,00

EXCLUSIVE COLLECTIONS



CUADRO

Una colección donde se miman todos los detalles. Con una línea estilizada, cuerpo compacto y de diseño actual, la serie Cuadro es artesanía pura para vestir los espacios más vanguardistas y aportar un toque de distinción.







GRIFOS PARA LAVABO

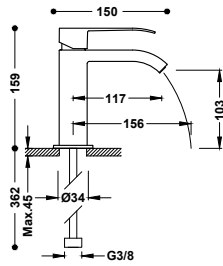

Grifo monomando para lavabo

Caño cerrado con salida del agua en cascada. Caudal limitado a 5 l/min. Latiguillos de alimentación flexibles G3/8. Se incluyen 2 llaves de regulación con filtro (ref: 9134525).



	00610101	163,00
	00610101D	186,00
	00610101NM	252,00
	00610101BM	252,00
	00610101AC	252,00
	00610101OR	358,00
	00610101OM	358,00
	00610101NE	252,00
	00610101BL	252,00

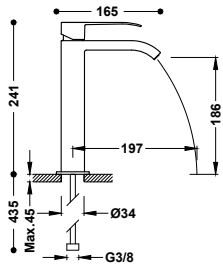

Grifo monomando alto para lavabo

Caño cerrado con salida del agua en cascada. Caudal limitado a 5 l/min. Latiguillos de alimentación flexibles G3/8. Se incluyen 2 llaves de regulación con filtro (ref: 9134525).



	00661001	313,00
	00661001NM	485,00
	00661001BM	485,00
	00661001AC	485,00
	00661001OR	688,00
	00661001OM	688,00
	00661001NE	485,00
	00661001BL	485,00

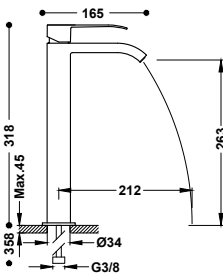

Grifo monomando XXL para lavabo

Caño cerrado con salida del agua en cascada. Caudal limitado a 5 l/min. Latiguillos de alimentación flexibles G3/8. Se incluyen 2 llaves de regulación con filtro (ref: 9134525).



	00681001	383,00
	00681001NM	594,00
	00681001BM	594,00
	00681001AC	594,00
	00681001OR	843,00
	00681001OM	843,00
	00681001NE	594,00
	00681001BL	594,00

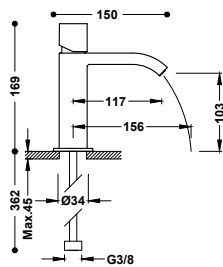

Grifo monomando para lavabo

Caño cerrado con salida del agua en cascada. Caudal limitado a 5 l/min. Latiguillos de alimentación flexibles G3/8. Se incluyen 2 llaves de regulación con filtro (ref: 9134525).



	00610102	163,00
	00610102D	186,00

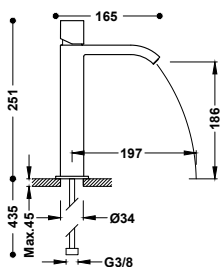

Grifo monomando alto para lavabo

Caño cerrado con salida del agua en cascada. Caudal limitado a 5 l/min. Latiguillos de alimentación flexibles G3/8. Se incluyen 2 llaves de regulación con filtro (ref: 9134525).



	00661002	313,00
--	----------	--------

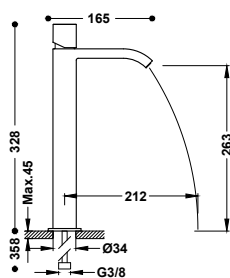

Grifo monomando XXL para lavabo

Caño cerrado con salida del agua en cascada. Caudal limitado a 5 l/min. Latiguillos de alimentación flexibles G3/8. Se incluyen 2 llaves de regulación con filtro (ref: 9134525).

00681002 383,00



29919001

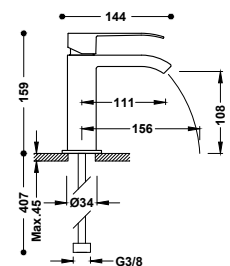

Grifo monomando para lavabo

Caño abierto con salida del agua en cascada. Latiguillos de alimentación flexibles G3/8. Se incluyen 2 llaves de regulación con filtro (ref: 9134525).

00611001 278,00
 00611001D 301,00
 00611001NE 431,00
 00611001BL 431,00



29919002

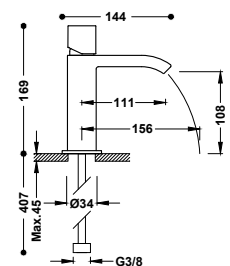

Grifo monomando para lavabo

Caño abierto con salida del agua en cascada. Latiguillos de alimentación flexibles G3/8. Se incluyen 2 llaves de regulación con filtro (ref: 9134525).

00611002 278,00
 00611002D 301,00
 00611002NE 431,00
 00611002BL 431,00



29919002

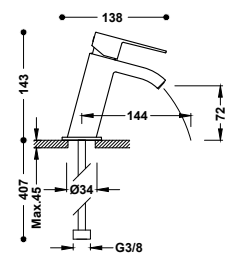

Grifo monomando inclinado para lavabo

Caño cerrado con salida del agua en cascada. Caudal limitado a 5 l/min. Latiguillos de alimentación flexibles G3/8. Se incluyen 2 llaves de regulación con filtro (ref: 9134525).

00620101 170,00
 00620101NM 264,00
 00620101BM 264,00
 00620101AC 264,00
 00620101OR 374,00
 00620101OM 374,00



29919001

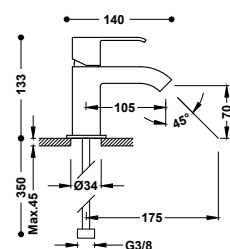

Grifo monomando para lavabo

Latiguillos de alimentación flexibles G3/8.

106103 160,00
 106103DA 183,00



9130190

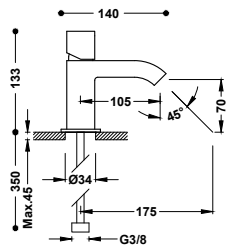

Grifo monomando para lavabo
Latiguillos de alimentación flexibles G3/8.

- 107103 160,00
- 107103DA 183,00

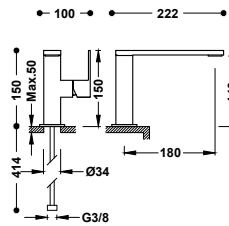

Grifo monomando con maneta lateral para lavabo
Latiguillos de alimentación flexibles G3/8.

- 10620501 263,00
- 00620501NM 407,00
- 00620501BM 407,00
- 00620501AC 407,00
- 00620501OR 578,00
- 00620501OM 578,00

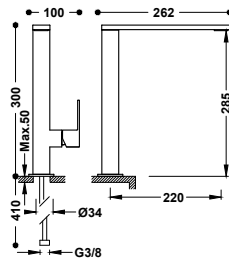

Grifo monomando alto con maneta lateral para lavabo
Latiguillos de alimentación flexibles G3/8.

- 00648501 305,00
- 00648501NM 472,00
- 00648501BM 472,00
- 00648501AC 472,00
- 00648501OR 670,00
- 00648501OM 670,00

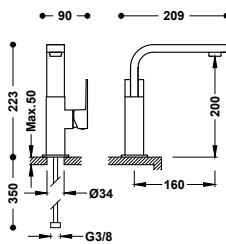

Grifo monomando con maneta lateral para lavabo
Latiguillos de alimentación flexibles G3/8.

- 106603 233,00

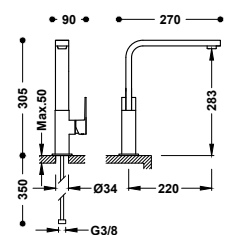

Grifo monomando alto con maneta lateral para lavabo
Latiguillos de alimentación flexibles G3/8.

- 106604 265,00

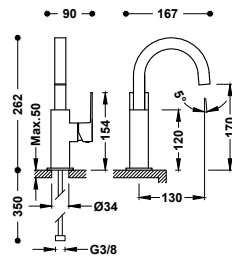

Grifo monomando con maneta lateral para lavabo
Latiguillos de alimentación flexibles G3/8.



106605	254,00
00660502NM	394,00
00660502BM	394,00
00660502AC	394,00
00660502OR	559,00
00660502OM	559,00

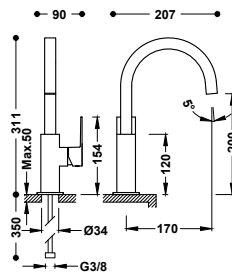

Grifo monomando alto con maneta lateral para lavabo
Latiguillos de alimentación flexibles G3/8.



106606	275,00
00660602NM	426,00
00660602BM	426,00
00660602AC	426,00
00660602OR	605,00
00660602OM	605,00

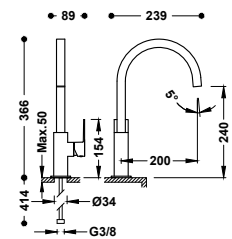

Grifo monomando XXL con maneta lateral para lavabo
Latiguillos de alimentación flexibles G3/8.



106607	286,00
00660702NM	443,00
00660702BM	443,00
00660702AC	443,00
00660702OR	628,00
00660702OM	628,00

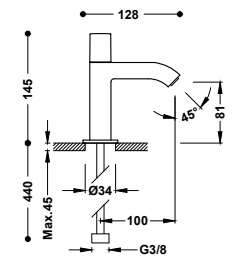

Grifo de 1 agua para lavabo
Con latiguillo de alimentación flexible G3/8.



107503	158,00
00750301NM	244,00
00750301BM	244,00
00750301AC	244,00
00750301OR	347,00
00750301OM	347,00

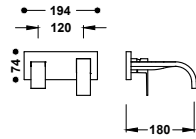

Pieza vista para cuerpo empotrado de lavabo

Solo parte vista. Incluye placa embellecedora, mando y caño de 180 mm. Cuerpo empotrado no incluido.

	00630031	190,00
	00630031NM	295,00
	00630031BM	295,00
	00630031AC	295,00
	00630031OR	418,00
	00630031OM	418,00



Cuerpo empotrado para grifo de lavabo

20830002 85,00

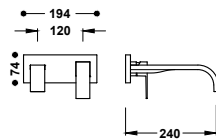

Pieza vista para cuerpo empotrado de lavabo

Solo parte vista. Incluye placa embellecedora, mando y caño de 240 mm. Cuerpo empotrado no incluido.

	00630032	200,00
	00630032NM	310,00
	00630032BM	310,00
	00630032AC	310,00
	00630032OR	440,00
	00630032OM	440,00



Cuerpo empotrado para grifo de lavabo

20830002 85,00

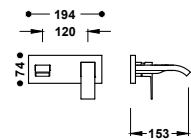

Pieza vista para cuerpo empotrado de lavabo

Solo parte vista. Incluye placa embellecedora, mando y caño de 153 mm. Cuerpo empotrado no incluido.

	00630033	240,00
	00630033NM	372,00
	00630033BM	372,00
	00630033AC	372,00
	00630033OR	528,00
	00630033OM	528,00



Cuerpo empotrado para grifo de lavabo

20830002 85,00

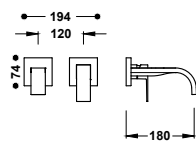

Pieza vista para cuerpo empotrado de lavabo

Solo parte vista. Incluye placa embellecedora, mando y caño de 180 mm. Cuerpo empotrado no incluido.

	00630021	157,00
	00630021NM	243,00
	00630021BM	243,00
	00630021AC	243,00
	00630021OR	345,00
	00630021OM	345,00



Cuerpo empotrado para grifo de lavabo

20830002 85,00

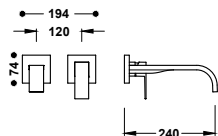

Pieza vista para cuerpo empotrado de lavabo

Solo parte vista. Incluye placa embellecedora, mando y caño de 240 mm. Cuerpo empotrado no incluido.

00630022	167,00
00630022NM	259,00
00630022BM	259,00
00630022AC	259,00
00630022OR	367,00
00630022OM	367,00



Cuerpo empotrado para grifo de lavabo

20830002	85,00
----------	-------

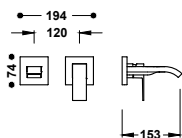

Pieza vista para cuerpo empotrado de lavabo

Solo parte vista. Incluye placa embellecedora, mando y caño de 153 mm. Cuerpo empotrado no incluido.

00630023	210,00
00630023NM	326,00
00630023BM	326,00
00630023AC	326,00
00630023OR	462,00
00630023OM	462,00



Cuerpo empotrado para grifo de lavabo

20830002	85,00
----------	-------

GRIFOS PARA BIDÉ

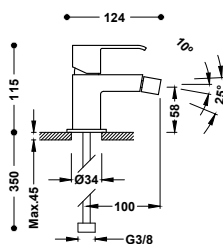

Grifo monomando para bidé

Rótula orientable. Latiguillos de alimentación flexibles G3/8.

00612001	166,00
00612001D	189,00
00612001NM	257,00
00612001BM	257,00
00612001AC	257,00
00612001OR	365,00
00612001OM	365,00
00612001NE	257,00
00612001BL	257,00

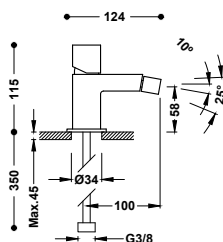

Grifo monomando para bidé

Rótula orientable. Latiguillos de alimentación flexibles G3/8.

00712001	166,00
00712001D	189,00
00712001NM	257,00
00712001BM	257,00
00712001AC	257,00
00712001OR	365,00
00712001OM	365,00
00712001NE	257,00
00712001BL	257,00



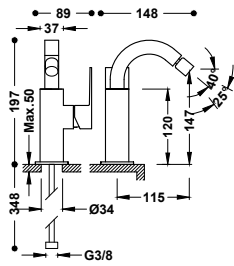

Grifo monomando con maneta lateral para bidé
Rótula orientable. Latiguillos de alimentación flexibles G3/8.

106124	233,00
00612402NM	361,00
00612402BM	361,00
00612402AC	361,00
00612402OR	513,00
00612402OM	513,00

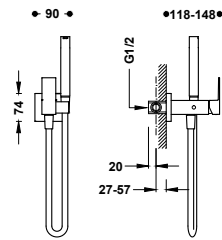

Grifo monomando empotrado con ducha para inodoro
Con agua fría y caliente. Ducha de mano con racor limitador a 5 l/min. y sistema antigoteo. Soporte fijo para la ducha de mano instalable a derecha o izquierda. Flexo satinado.

00612301	200,00
00612301NM	310,00
00612301BM	310,00
00612301AC	310,00
00612301OR	440,00
00612301OM	440,00

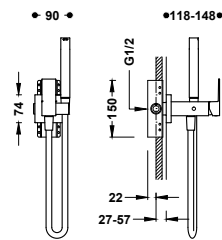

Grifo monomando empotrado con ducha para inodoro
Opción para paredes de Pladur. Con agua fría y caliente. Ducha de mano con racor limitador a 5 l/min. y sistema antigoteo. Soporte fijo para la ducha de mano instalable a derecha o izquierda. Flexo satinado.

00612302	240,00
00612302NM	372,00
00612302BM	372,00
00612302AC	372,00



Accesorio porta toallas para grifo con ducha para inodoro
Soporte instalable a derecha o izquierda (para ref.: 00612301, 00612302). Long: 180 mm.

03412402	47,00
03412402NM	73,00
03412402BM	73,00
03412402AC	73,00
03412402OR	104,00
03412402OM	104,00

GRIFOS MURALES

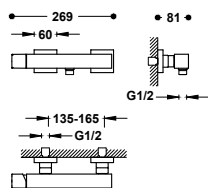

Grifo monomando mural para ducha

Ducha de mano anticalcárea de latón. Soporte orientable para ducha de mano. Flexo satinado.

107167	313,00
00716703NM	485,00
00716703BM	485,00
50716703	485,00
00716703OR	688,00
00716703OM	688,00

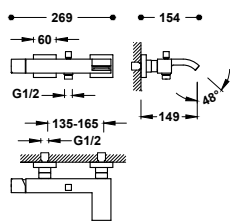

Grifo monomando mural para bañera y ducha

Con salida de agua en cascada. Ducha de mano anticalcárea de latón. Soporte orientable para ducha de mano. Flexo satinado.

10717002	334,00
0071700203NM	518,00
0071700203BM	518,00
5071700203	518,00
0071700203OR	735,00
0071700203OM	735,00

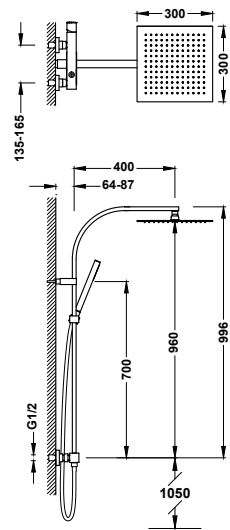

Conjunto de grifo monomando mural de 2 vías para ducha

- Rociador de ducha orientable de acero inoxidable: 300x300 mm.
- Soporte deslizante y orientable para ducha de mano.
- Ducha de mano anticalcárea de latón.
- Flexo satinado.

00719102	680,00
----------	--------



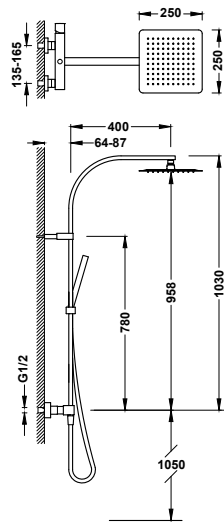

Conjunto de grifo monomando mural de 2 vías para ducha

00719101

635,00

- Rociador de ducha orientable de acero inoxidable: 250x250 mm.
- Soporte deslizante y orientable para ducha de mano.
- Ducha de mano anticalcárea de latón.
- Flexo satinado.

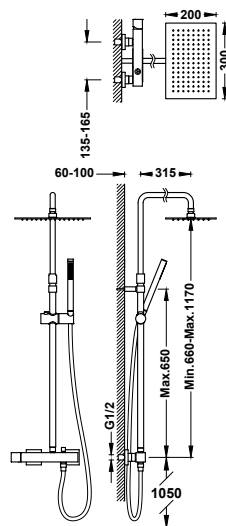

Conjunto de grifo monomando mural de 2 vías para ducha

00719702

626,00

- Rociador de ducha orientable de acero inoxidable: 300x200 mm.
- Barra de ducha telescópica.
- Soporte deslizante y orientable para ducha de mano.
- Ducha de mano anticalcárea de latón.
- Flexo satinado.

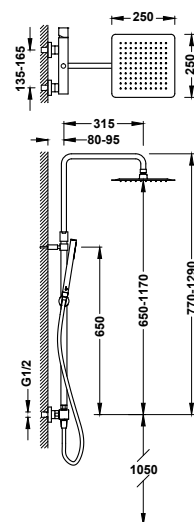

Conjunto de grifo monomando mural de 2 vías para ducha

00719701

582,00

- Rociador de ducha orientable de acero inoxidable: 250x250 mm.
- Barra de ducha telescópica.
- Soporte deslizante y orientable para ducha de mano.
- Ducha de mano anticalcárea de latón.
- Flexo satinado.



GRIFOS EMPOTRADOS

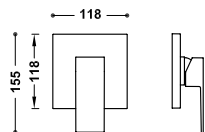

Pieza vista para caja empotrada de 1 vía Rapid-box

Sólo parte vista. Incluye placa embellecedora, mando, casquillo y tornillo de fijación oculto. Completar con la caja empotrada Rapid-box ref: 20827810.

10627810	89,00
10627810NM	138,00
10627810BM	138,00
10627810AC	138,00
10627810OR	196,00
10627810OM	196,00



Caja empotrada de 1 vía Rapid-box con grifo monomando para ducha

20827810	80,00
----------	-------

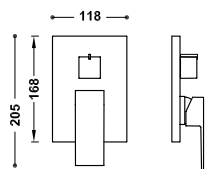

Pieza vista para caja empotrada de 2 vías Rapid-box

Sólo parte vista. Incluye placa embellecedora, mando, volante distribuidor y tornillo de fijación oculto. Completar con la caja empotrada Rapid-box ref: 20828110.

10628110	116,00
10628110NM	179,00
10628110BM	179,00
10628110AC	179,00
10628110OR	254,00
10628110OM	254,00



Caja empotrada de 2 vías Rapid-box con grifo monomando para ducha y bañera

20828110	90,00
----------	-------

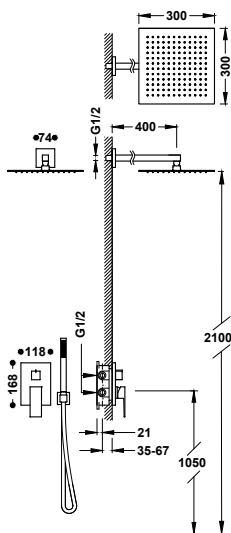

Kit de grifo monomando empotrado de 2 vías Rapid-box para ducha

- Cuerpo empotrado incluido.
- Distribuidor cerámico de 2 vías.
- Brazo a pared con rociador de ducha orientable y de acero inoxidable: 300x300 mm.
- Soporte para ducha de mano con toma de agua a pared.
- Ducha de mano anticalcárea de latón.
- Flexo satinado.

00628004	582,00
00628004NM	853,00
00628004BM	853,00
00628004AC	853,00
00628004OR	1.174,00
00628004OM	1.174,00



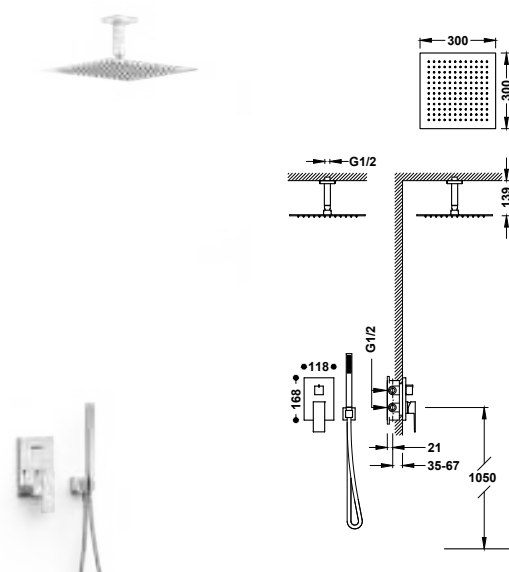

**Kit de grifo monomando empotrado de 2 vías
Rapid-box para ducha**

- Cuerpo empotrado incluido.
- Distribuidor cerámico de 2 vías.
- Brazo a techo con rociador de ducha orientable y de acero inoxidable: 300x300 mm.
- Soporte para ducha de mano con toma de agua a pared.
- Ducha de mano anticalcárea de latón.
- Flexo satinado.

00628003	559,00
00628003NM	818,00
00628003BM	818,00
00628003AC	818,00
00628003OR	1.125,00
00628003OM	1.125,00

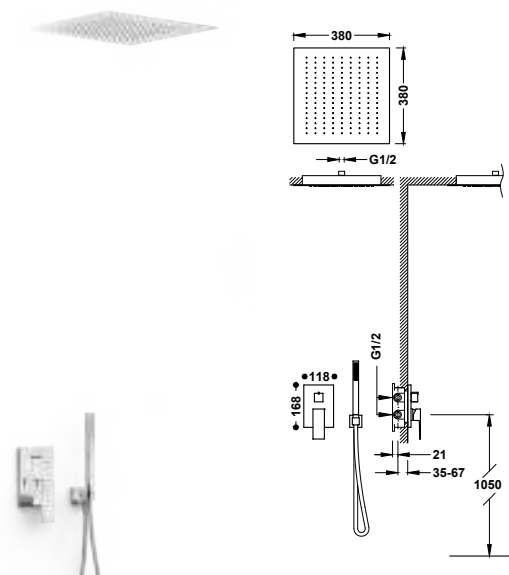

**Kit de grifo monomando empotrado de 2 vías
Rapid-box para ducha**

- Cuerpo empotrado incluido.
- Distribuidor cerámico de 2 vías.
- Rociador de ducha empotrado a techo de acero inoxidable: 380x380 mm.
- Soporte para ducha de mano con toma de agua a pared.
- Ducha de mano anticalcárea de latón.
- Flexo satinado.

00628005	1.097,00
00628005NM	1.654,00
00628005BM	1.654,00
00628005AC	1.654,00
00628005OR	2.312,00
00628005OM	2.312,00

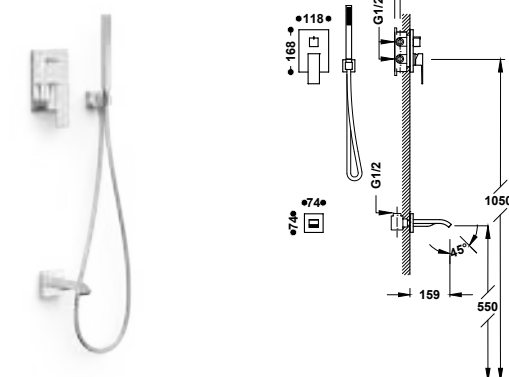

**Kit de grifo monomando empotrado de 2 vías
Rapid-box para bañera y ducha**

- Cuerpo empotrado incluido.
- Distribuidor cerámico de 2 vías.
- Caño fijo de bañera a pared.
- Soporte para ducha de mano con toma de agua a pared.
- Ducha de mano anticalcárea de latón.
- Flexo satinado.

00628006	459,00
00628006NM	662,00
00628006BM	662,00
00628006AC	662,00
00628006OR	903,00
00628006OM	903,00

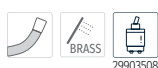

Grifo monomando empotrado de 1 vía para ducha

106177

126,00

Cuerpo empotrado incluido.

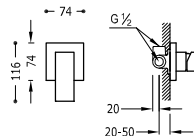

Alargadera para grifo monomando empotrado de 1 vía para ducha

10617710

95,00

Grifo monomando empotrado de 2 vías para bañera y ducha

106180

210,00

Cuerpo empotrado incluido. Inversor de 2 vías.

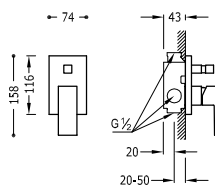

Set de prolongación para los grifos monomando empotrado de 2 vías

10618010

105,00



Kit de grifo monomando empotrado de 2 vías para ducha

00698003

582,00

- Cuerpo empotrado incluido.
- Inversor de 2 vías.
- Brazo a pared con rociador de ducha orientable y de acero inoxidable: 300x200 mm.
- Soporte para ducha de mano con toma de agua a pared.
- Ducha de mano anticalcárea de latón.
- Flexo satinado.

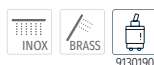
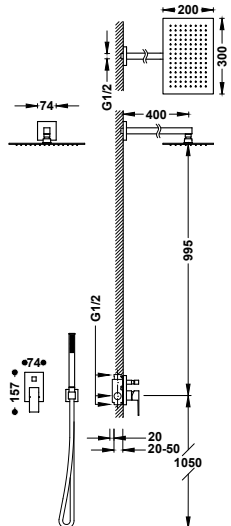

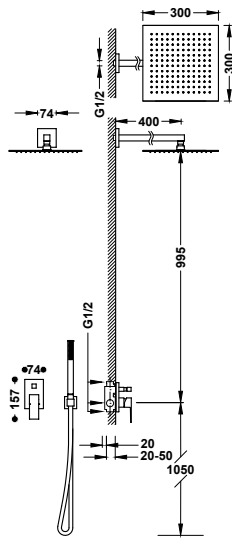

Kit de grifo monomando empotrado de 2 vías para ducha

106980 561,00

- Cuerpo empotrado incluido.
- Inversor de 2 vías.
- Brazo a pared con rociador de ducha orientable y de acero inoxidable: 300x300 mm.
- Soporte para ducha de mano con toma de agua a pared.
- Ducha de mano anticalcárea de latón.
- Flexo satinado.

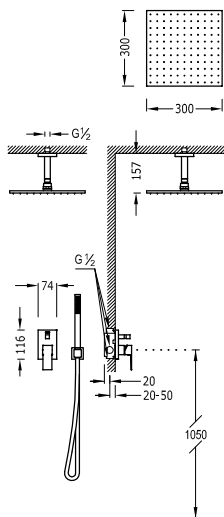

Kit de grifo monomando empotrado de 2 vías para ducha

00618080 550,00

- Cuerpo empotrado incluido.
- Inversor de 2 vías.
- Brazo a techo con rociador de ducha orientable y de acero inoxidable: 300x300 mm.
- Soporte para ducha de mano con toma de agua a pared.
- Ducha de mano anticalcárea de latón.
- Flexo satinado.

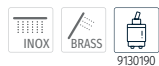

GRIFOS PARA BAÑERA

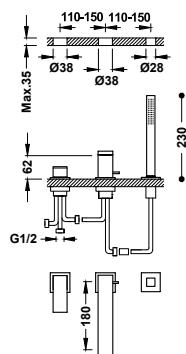

Grifo monomando para borde de bañera

- 00616105 462,00
- 00616105NM 716,00
- 00616105BM 716,00
- 00616105AC 716,00
- 00616105OR 1.016,00
- 00616105OM 1.016,00

- Inversor integrado en el caño de bañera.
- Ducha de mano anticalcárea de latón.
- Caño de bañera de 180 mm. Caudal: 3 bar - 13 l/m.
- Kit depósito opcional no incluido ref.: 20024501.

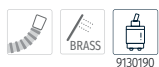

Depósito para grifería de borde de bañera

20024501 415,00

- Color options: [Color swatches] → 406



Válvula de desagüe Click-clack para bañera con rebosadero y toma de drenaje

134445 100,00

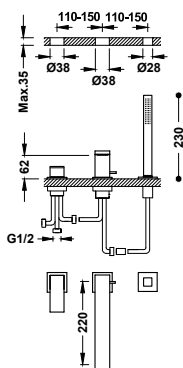

Grifo monomando para borde de bañera

- Inversor integrado en el caño de bañera.
- Ducha de mano anticalcárea de latón.
- Caño de bañera de 220 mm. Caudal: 3 bar - 13 l/m.
- Kit depósito opcional no incluido ref: 20024501.

	00616103	410,00
	00616103NM	636,00
	00616103BM	636,00
	00616103AC	636,00
	00616103OR	902,00
	00616103OM	902,00

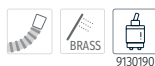

Depósito para grifería de borde de bañera

	20024501	415,00
--	----------	--------



Válvula de desagüe Click-clack para bañera con rebosadero y toma de drenaje

	134445	100,00
--	--------	--------

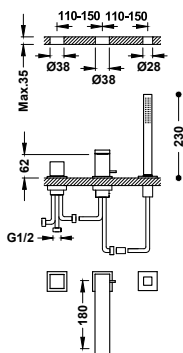

Grifo monomando para borde de bañera

- Inversor integrado en el caño de bañera.
- Ducha de mano anticalcárea de latón.
- Caño de bañera de 180 mm. Caudal: 3 bar - 13 l/min.
- Kit depósito opcional no incluido ref: 20024501.

	00616106	400,00
--	----------	--------

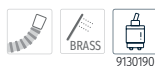

Depósito para grifería de borde de bañera

	20024501	415,00
--	----------	--------

Válvula de desagüe Click-clack para bañera con rebosadero y toma de drenaje

	134445	100,00
--	--------	--------

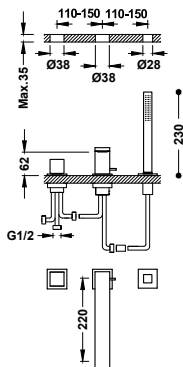

Grifo monomando para borde de bañera

- Inversor integrado en el caño de bañera.
- Ducha de mano anticalcárea de latón.
- Caño de bañera de 220 mm. Caudal: 3 bar - 13 l/min.
- Kit depósito opcional no incluido ref: 20024501.

	00616104	473,00
--	----------	--------

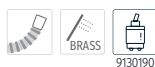

Depósito para grifería de borde de bañera

	20024501	415,00
--	----------	--------

Válvula de desagüe Click-clack para bañera con rebosadero y toma de drenaje

	134445	100,00
--	--------	--------

GRIFOS TERMOSTÁTICOS EMPOTRADOS

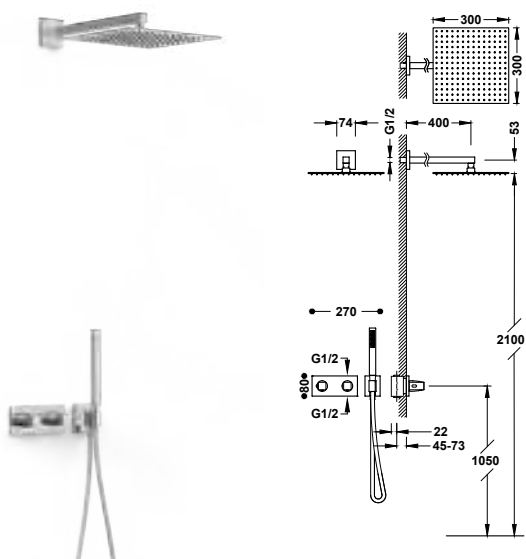

Kit de grifo termostático empotrado de 2 vías B-system para ducha

- Cuerpo empotrado termostático de instalación horizontal incluido.
- Regulador de caudal y distribuidor cerámico de 2 vías.
- Volante cuadrado-redondo.
- Brazo a pared con rociador de ducha orientable y de acero inoxidable: 300x300 mm.
- Soporte para ducha de mano con toma de agua a pared.
- Ducha de mano anticalcárea de latón.
- Flexo satinado.

30725204	782,00
30725204NM	1.210,00
30725204AC	1.210,00
30725204OR	1.718,00
30725204OM	1.718,00

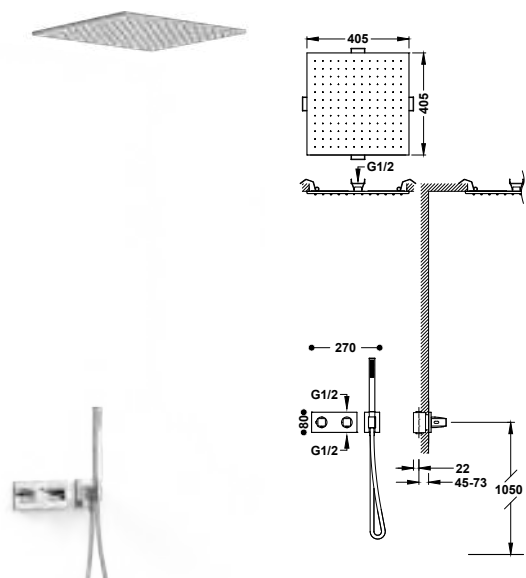

Kit de grifo termostático empotrado de 2 vías B-system para ducha

- Cuerpo empotrado termostático de instalación horizontal incluido.
- Regulador de caudal y distribuidor cerámico de 2 vías.
- Volante cuadrado-redondo.
- Rociador de ducha empotrado a techo de acero inoxidable: 405x405 mm.
- Soporte para ducha de mano con toma de agua a pared.
- Ducha de mano anticalcárea de latón.
- Flexo satinado.

30725206	1.315,00
30725206NM	1.855,00
30725206AC	1.855,00
30725206OR	2.895,00
30725206OM	2.895,00

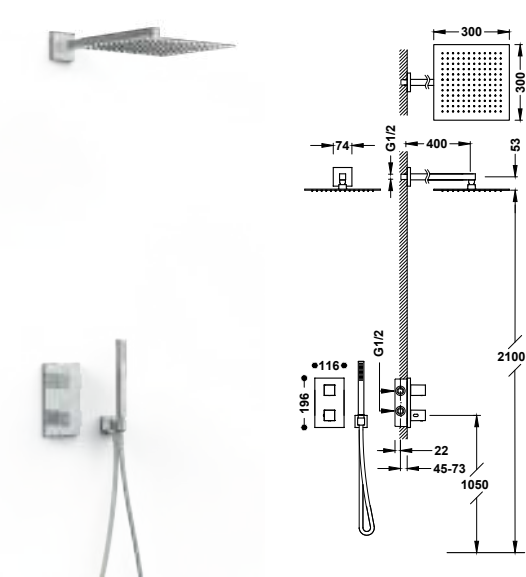

Kit de grifo termostático empotrado de 2 vías Therm-box para ducha

- Cuerpo empotrado incluido.
- Volante cuadrado con control de temperatura. Distribuidor cerámico de 2 vías.
- Brazo a pared con rociador de ducha orientable y de acero inoxidable: 300x300 mm.
- Soporte para ducha de mano con toma de agua a pared.
- Ducha de mano anticalcárea de latón.
- Flexo satinado.

00625004	641,00
00625004NM	922,00
00625004BM	922,00
00625004AC	922,00
00625004OR	1.256,00
00625004OM	1.256,00



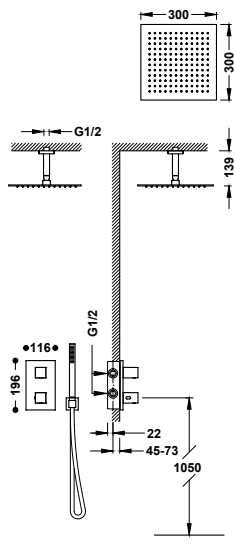

**Kit de grifo termostático empotrado de 2 vías
Therm-box para ducha**

- Cuerpo empotrado incluido.
- Volante cuadrado con control de temperatura. Distribuidor cerámico de 2 vías.
- Brazo a techo con rociador de ducha orientable y de acero inoxidable: 300x300 mm.
- Soporte para ducha de mano con toma de agua a pared.
- Ducha de mano anticalcárea de latón.
- Flexo satinado.

00625003	620,00
00625003NM	888,00
00625003BM	888,00
00625003AC	888,00
00625003OR	1.207,00
00625003OM	1.207,00



LLAVES DE PASO

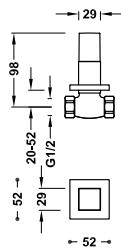

Llave de paso empotrada

Conexión a rosca hembra: 1/2".

00715501	89,00
00715501NM	137,00
00715501BM	137,00
00715501AC	137,00
00715501OR	196,00
00715501OM	196,00

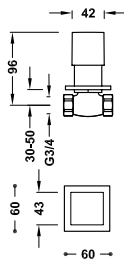

Llave de paso empotrada

Conexión a rosca hembra: 3/4".

107511	96,00
--------	-------



LOFT

El equilibrio entre las superficies planas y las redondeadas dan como resultado una colección muy amplia y versátil. Loft es la serie que mejor encaja y siempre acierta. Diseñada para el agua.

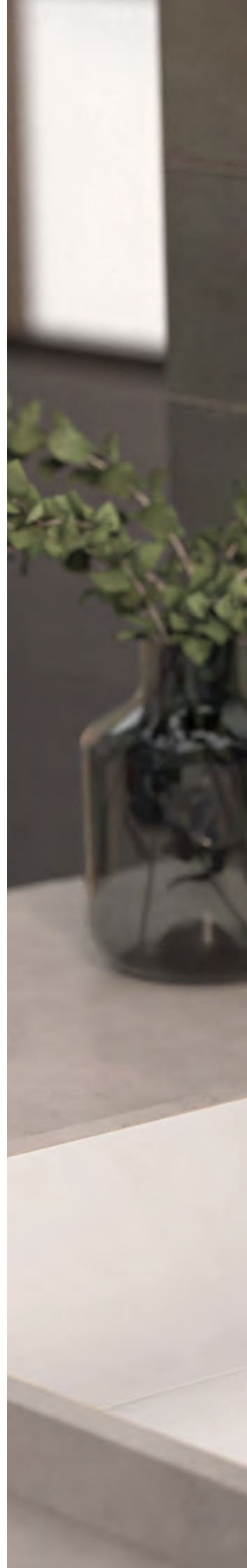





GRIFOS PARA LAVABO

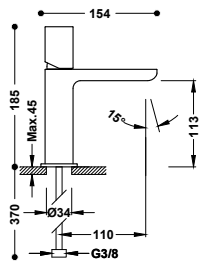

Grifo monomando para lavabo

Latiguillos de alimentación flexibles G3/8.



20010302	131,00
20010302D	154,00
20010302NM	203,00
20010302BM	203,00
20010302AC	203,00
20010302OR	289,00
20010302OM	289,00
20010302NE	203,00
20010302BL	203,00

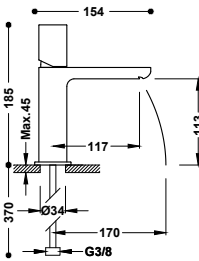

Grifo monomando para lavabo

Caño cerrado con salida del agua en cascada. Latiguillos de alimentación flexibles G3/8. Se incluyen 2 llaves de regulación con filtro (ref: 9134525).



20010102	158,00
20010102D	181,00

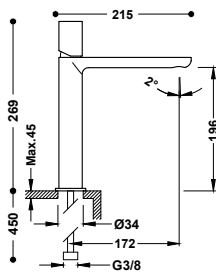

Grifo monomando alto para lavabo

Latiguillos de alimentación flexibles G3/8.



20020304	244,00
20020304NM	378,00
20020304BM	378,00
20020304AC	378,00
20020304OR	536,00
20020304OM	536,00
20020304NE	378,00
20020304BL	378,00

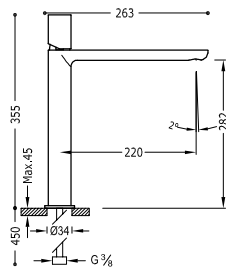

Grifo monomando XXL para lavabo

Latiguillos de alimentación flexibles G3/8.



20020306	278,00
20020306NM	431,00
20020306BM	431,00
20020306AC	431,00
20020306OR	612,00
20020306OM	612,00
20020306NE	431,00
20020306BL	431,00

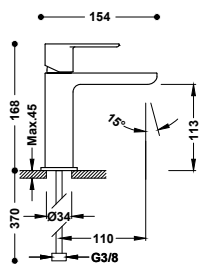

Grifo monomando para lavabo

Latiguillos de alimentación flexibles G3/8.



20010301	131,00
20010301D	154,00
20010301NM	203,00
20010301BM	203,00
20010301AC	203,00
20010301OR	289,00
20010301OM	289,00
20010301NE	203,00
20010301BL	203,00

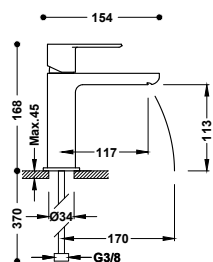

Grifo monomando para lavabo

Caño cerrado con salida del agua en cascada. Latiguillos de alimentación flexibles G3/8. Se incluyen 2 llaves de regulación con filtro (ref: 9134525).



9130190

- 20010101 158,00
- 20010101D 181,00

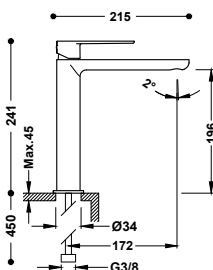

Grifo monomando alto para lavabo

Latiguillos de alimentación flexibles G3/8.



9130190

- 20020303 244,00
- 20020303NM 378,00
- 20020303BM 378,00
- 20020303AC 378,00
- 20020303OR 536,00
- 20020303OM 536,00
- 20020303NE 378,00
- 20020303BL 378,00

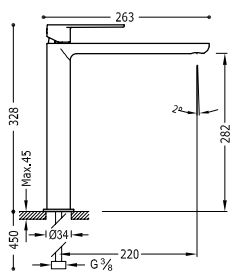

Grifo monomando XXL para lavabo

Latiguillos de alimentación flexibles G3/8.



9130190

- 20020305 278,00
- 20020305NM 431,00
- 20020305BM 431,00
- 20020305AC 431,00
- 20020305OR 612,00
- 20020305OM 612,00
- 20020305NE 431,00
- 20020305BL 431,00

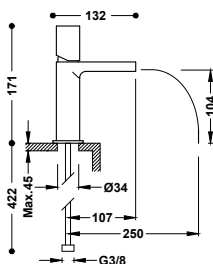

Grifo monomando para lavabo

Caño abierto con salida del agua en cascada. Latiguillos de alimentación flexibles G3/8. Se incluyen 2 llaves de regulación con filtro (ref: 9134525).



9130190

- 20011002 223,00
- 20011002NE 345,00
- 20011002BL 345,00

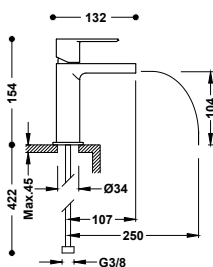

Grifo monomando para lavabo

Caño abierto con salida del agua en cascada. Latiguillos de alimentación flexibles G3/8. Se incluyen 2 llaves de regulación con filtro (ref: 9134525).



9130190

- 20011001 223,00
- 20011001NE 345,00
- 20011001BL 345,00

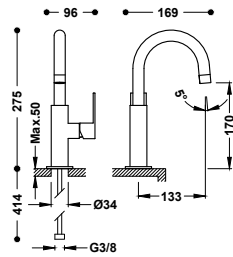

Grifo monomando con maneta lateral para lavabo
Latiguillos de alimentación flexibles G3/8.



20020504	210,00
20020504NM	326,00
20020504BM	326,00
20020504AC	326,00
20020504OR	462,00
20020504OM	462,00
20020504NE	326,00
20020504BL	326,00

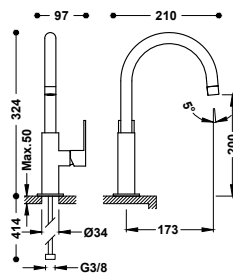

Grifo monomando alto con maneta lateral para lavabo
Latiguillos de alimentación flexibles G3/8.



20020505	221,00
20020505NM	342,00
20020505BM	342,00
20020505AC	342,00
20020505OR	485,00
20020505OM	485,00
20020505NE	342,00
20020505BL	342,00

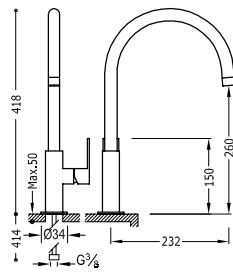

Grifo monomando XXL con maneta lateral para lavabo
Latiguillos de alimentación flexibles G3/8.



20020506	231,00
20020506NM	358,00
20020506BM	358,00
20020506AC	358,00
20020506OR	508,00
20020506OM	508,00
20020506NE	358,00
20020506BL	358,00

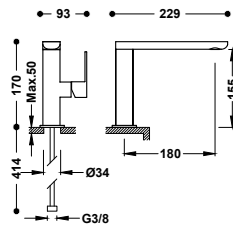

Grifo monomando con maneta lateral para lavabo
Latiguillos de alimentación flexibles G3/8.



20020501	194,00
20020501NM	301,00
20020501BM	301,00
20020501AC	301,00
20020501OR	427,00
20020501OM	427,00
20020501NE	301,00
20020501BL	301,00

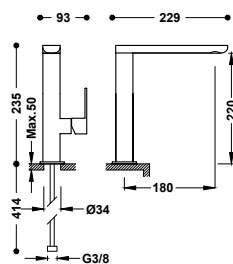

Grifo monomando alto con maneta lateral para lavabo
Latiguillos de alimentación flexibles G3/8.



20020502	215,00
20020502NM	334,00
20020502BM	334,00
20020502AC	334,00
20020502OR	474,00
20020502OM	474,00
20020502NE	334,00
20020502BL	334,00

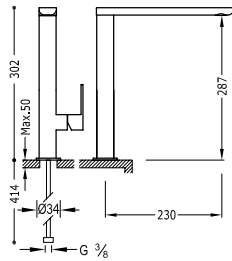

Grifo monomando XXL con maneta lateral para lavabo
Latiguillos de alimentación flexibles G3/8.



20020503	236,00
20020503NM	366,00
20020503BM	366,00
20020503AC	366,00
20020503OR	520,00
20020503OM	520,00
20020503NE	366,00
20020503BL	366,00

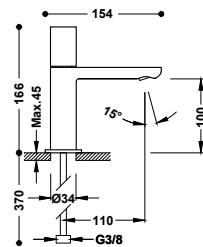

Grifo de 1 agua para lavabo
Con latiguillo de alimentación flexible G3/8.

20050301	100,00
20050301NM	155,00
20050301BM	155,00
20050301AC	155,00
20050301OR	219,00
20050301OM	219,00

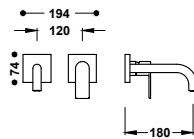

Pieza vista para cuerpo empotrado de lavabo
Solo parte vista. Incluye placa embellecedora, mando y caño de 180 mm. Cuerpo empotrado no incluido.

20030021	150,00
20030021NM	233,00
20030021BM	233,00
20030021AC	233,00
20030021OR	330,00
20030021OM	330,00



Cuerpo empotrado para grifo de lavabo

20830002	85,00
----------	-------

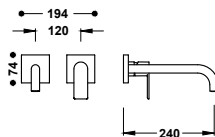

Pieza vista para cuerpo empotrado de lavabo
Solo parte vista. Incluye placa embellecedora, mando y caño de 240 mm. Cuerpo empotrado no incluido.

20030022	160,00
20030022NM	248,00
20030022BM	248,00
20030022AC	248,00
20030022OR	352,00
20030022OM	352,00



Cuerpo empotrado para grifo de lavabo

20830002	85,00
----------	-------

GRIFOS PARA BIDÉ

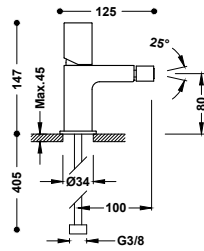

Grifo monomando para bidé

Rótula orientable. Latiguillos de alimentación flexibles G3/8.

20012002	134,00
20012002D	158,00
20012002NM	208,00
20012002BM	208,00
20012002AC	208,00
20012002OR	296,00
20012002OM	296,00
20012002NE	208,00
20012002BL	208,00

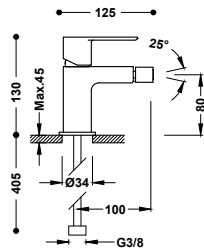

Grifo monomando para bidé

Rótula orientable. Latiguillos de alimentación flexibles G3/8.

20012001	134,00
20012001D	158,00
20012001NM	208,00
20012001BM	208,00
20012001AC	208,00
20012001OR	296,00
20012001OM	296,00
20012001NE	208,00
20012001BL	208,00

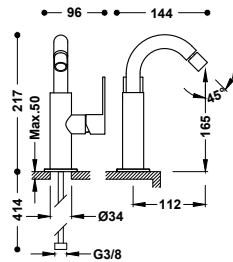

Grifo monomando con maneta lateral para bidé

Rótula orientable. Latiguillos de alimentación flexibles G3/8.

20022401	202,00
20022401NM	312,00
20022401BM	312,00
20022401AC	312,00
20022401OR	444,00
20022401OM	444,00
20022401NE	312,00
20022401BL	312,00

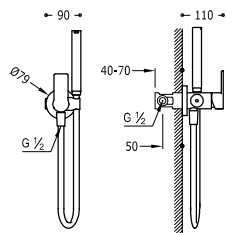

Grifo monomando empotrado con ducha para inodoro

Con agua fría y caliente. Ducha de mano con racor limitador a 5 l/min. y sistema antigoteo. Soporte fijo para la ducha de mano instalable a derecha o izquierda. Flexo satinado.

20522301	189,00
20522301NM	293,00
20522301BM	293,00
20522301AC	293,00
20522301OR	416,00
20522301OM	416,00

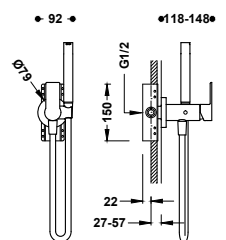

Grifo monomando empotrado con ducha para inodoro

Opción para paredes de Pladur. Con agua fría o caliente. Ducha de mano con racor limitador a 5 l/min. y sistema antigoteo. Soporte fijo para la ducha de mano instalable a derecha o izquierda. Flexo satinado.

20522201	231,00
20522201NM	358,00
20522201BM	358,00
20522201AC	358,00



Accesorio porta toallas para grifo con ducha para inodoro

Soporte instalable a derecha o izquierda (para ref.: 134122, 134123, 181122, 181123, 181222, 181223, 20522201, 20522301). Long: 180 mm.

	03412401	37,00
	03412401NM	57,00
	03412401BM	57,00
	03412401AC	57,00
	03412401OR	81,00
	03412401OM	81,00

GRIFOS MURALES

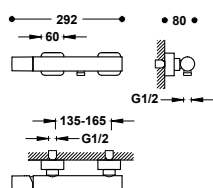

Grifo monomando mural para ducha

Ducha de mano anticalcárea. Soporte orientable para ducha de mano. Flexo satinado.

	20016701	247,00
	20016701NM	382,00
	20016701BM	382,00
	20016701AC	382,00
	20016701OR	543,00
	20016701OM	543,00

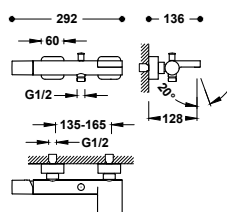

Grifo monomando mural para bañera y ducha

Con salida de agua en cascada. Ducha de mano anticalcárea. Soporte orientable para ducha de mano. Flexo satinado.

	20017001	268,00
	20017001NM	415,00
	20017001BM	415,00
	20017001AC	415,00
	20017001OR	589,00
	20017001OM	589,00



GRIFOS EMPOTRADOS

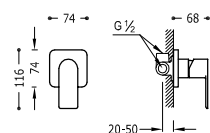

Grifo monomando empotrado de 1 vía para ducha

Cuerpo empotrado incluido.

	20017701	116,00
--	----------	--------

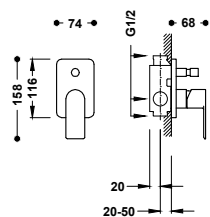

Grifo monomando empotrado de 2 vías para bañera y ducha

Cuerpo empotrado incluido. Inversor de 2 vías.

	20018001	179,00
	20018001NM	277,00
	20018001BM	277,00
	20018001AC	277,00
	20018001OR	393,00
	20018001OM	393,00



Set de prolongación para los grifos monomando empotrado de 2 vías

	20018010	100,00
--	----------	--------



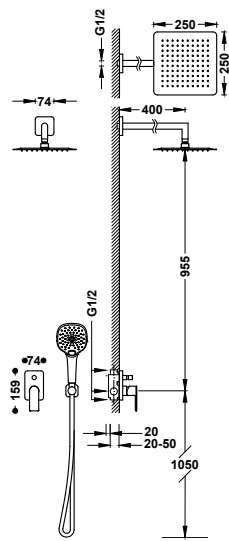

Kit de grifo monomando empotrado de 2 vías para ducha

20018011 453,00

- Cuerpo empotrado incluido.
- Inversor de 2 vías.
- Brazo a pared con rociador de ducha orientable y de acero inoxidable: 250x250mm.
- Soporte para ducha de mano con toma de agua a pared.
- Ducha de mano anticalcárea: 120x120 mm. (3 tipos de chorro).
- Flexo satinado.

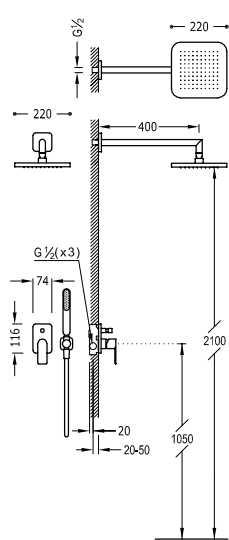

Kit de grifo monomando empotrado de 2 vías para ducha

20018002 479,00

- Cuerpo empotrado incluido.
- Inversor de 2 vías.
- Brazo a pared con rociador de ducha orientable: 220x220 mm.
- Soporte para ducha de mano con toma de agua a pared.
- Ducha de mano anticalcárea.
- Flexo satinado.

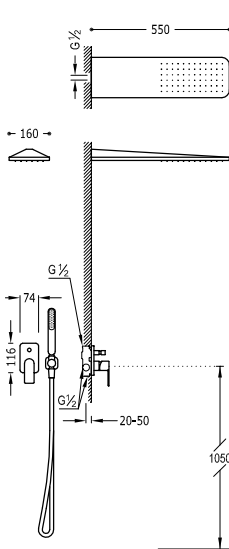

Kit de grifo monomando empotrado de 2 vías para ducha

20018005	725,00
20018005NM	1.124,00
20018005BM	1.124,00
20018005AC	1.124,00
20018005OR	1.596,00
20018005OM	1.596,00

- Cuerpo empotrado incluido.
- Inversor de 2 vías.
- Rociador de ducha a pared de acero inoxidable: 160x550 mm.
- Soporte para ducha de mano con toma de agua a pared.
- Ducha de mano anticalcárea.
- Flexo satinado.



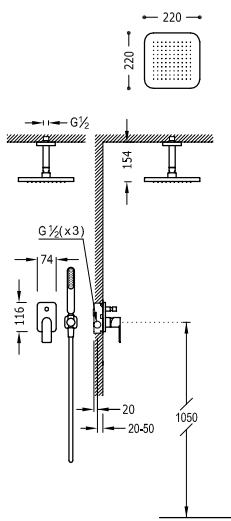

Kit de grifo monomando empotrado de 2 vías para ducha

20018080 446,00

- Cuerpo empotrado incluido.
- Inversor de 2 vías.
- Brazo a techo con rociador de ducha orientable: 220x220 mm.
- Soporte para ducha de mano con toma de agua a pared.
- Ducha de mano anticalcárea.
- Flexo satinado.

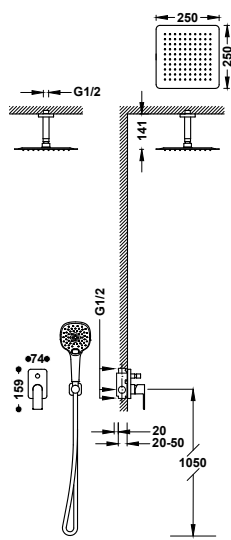

Kit de grifo monomando empotrado de 2 vías para ducha

20018009 419,00

- Cuerpo empotrado incluido.
- Inversor de 2 vías.
- Brazo a techo con rociador de ducha orientable y de acero inoxidable: 250x250mm.
- Soporte para ducha de mano con toma de agua a pared.
- Ducha de mano anticalcárea: 120x120 mm. (3 tipos de chorro).
- Flexo satinado.



GRIFOS PARA BAÑERA

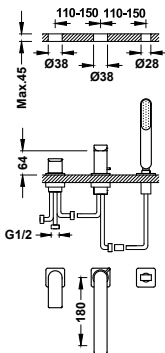

Grifo monomando para borde de bañera

20016203 390,00
 20016203NM 605,00
 20016203BM 605,00
 20016203AC 605,00
 20016203OR 858,00
 20016203OM 858,00

- Inversor integrado en el caño de bañera.
- Ducha de mano anticalcárea.
- Caño de bañera de 180 mm. Caudal: 3 bar - 16 l/min.
- Kit depósito opcional no incluido ref.: 20324501.



Depósito para grifería de borde de bañera

20324501 415,00

ABS INOX ABS ABS ABS ABS →406

Válvula de desagüe Click-clack para bañera con rebosadero y toma de drenaje

134445 100,00

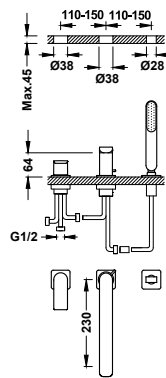

Grifo monomando para borde de bañera

- Inversor integrado en el caño de bañera.
- Ducha de mano anticalcárea.
- Caño de bañera de 230 mm. Caudal: 3 bar - 16 l/m.
- Kit depósito opcional no incluido ref.: 20324501.

20016201	400,00
20016201NM	620,00
20016201BM	620,00
20016201AC	620,00
20016201OR	880,00
20016201OM	880,00



Depósito para grifería de borde de bañera

20324501	415,00
----------	--------



Válvula de desagüe Click-clack para bañera con rebosadero y toma de drenaje

134445	100,00
--------	--------

GRIFOS TERMOSTÁTICOS MURALES

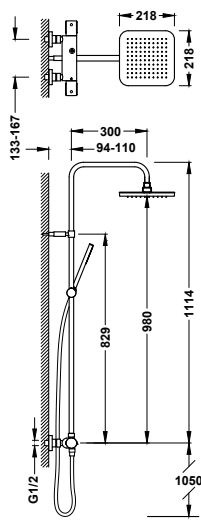

Conjunto de grifo termostático mural Over-wall de 2 vías para ducha

19039318	443,00
----------	--------

- Con inversor integrado en el regulador de caudal.
- Volante redondo de ABS.
- Rociador de ducha orientable: 218x218 mm.
- Soporte deslizante y orientable para ducha de mano.
- Ducha de mano anticalcárea.
- Flexo metálico.

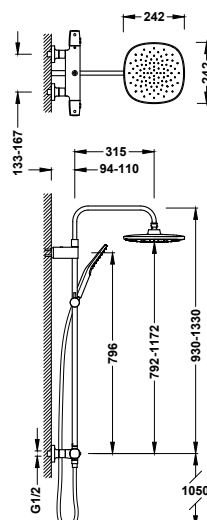

Conjunto de grifo termostático mural Over-wall de 2 vías para ducha

19038707	435,00
----------	--------

- Con inversor integrado en el regulador de caudal.
- Barra de ducha telescópica.
- Volante con bordes redondeados.
- Rociador de ducha orientable: 242x242 mm.
- Soporte deslizante y orientable para ducha de mano.
- Ducha de mano anticalcárea: 120x120 mm. (3 tipos de chorro).
- Flexo satinado.

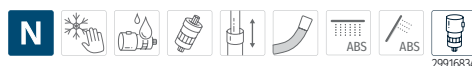

GRIFOS TERMOSTÁTICOS EMPOTRADOS

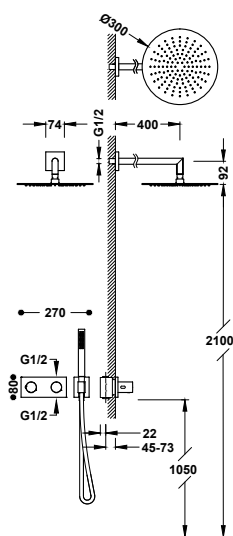

Kit de grifo termostático empotrado de 2 vías B-system para ducha

- Cuerpo empotrado termostático de instalación horizontal incluido.
- Regulador de caudal y distribuidor cerámico de 2 vías.
- Volante redondo.
- Brazo a pared con rociador de ducha orientable y de acero inoxidable: Ø 300 mm.
- Soporte para ducha de mano con toma de agua a pared.
- Ducha de mano anticalcárea de latón.
- Flexo satinado.

30735204	811,00
30735204NM	1.163,00
30735204AC	1.163,00
30735204OR	1.651,00
30735204OM	1.651,00

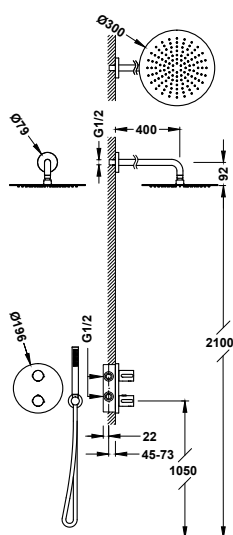

Kit de grifo termostático empotrado de 2 vías Therm-box para ducha

- Cuerpo empotrado incluido.
- Volante redondo con control de temperatura. Distribuidor cerámico de 2 vías.
- Brazo a pared con rociador de ducha orientable y de acero inoxidable: Ø 300 mm.
- Soporte para ducha de mano con toma de agua a pared.
- Ducha de mano anticalcárea de latón.
- Flexo satinado.

26225004	585,00
26225004NM	837,00
26225004BM	837,00
26225004AC	837,00
26225004OR	1.136,00
26225004OM	1.136,00

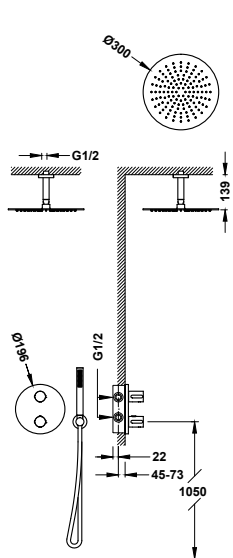

Kit de grifo termostático empotrado de 2 vías Therm-box para ducha

- Cuerpo empotrado incluido.
- Volante redondo con control de temperatura. Distribuidor cerámico de 2 vías.
- Brazo a techo con rociador de ducha orientable y de acero inoxidable: Ø 300 mm.
- Soporte para ducha de mano con toma de agua a pared.
- Ducha de mano anticalcárea de latón.
- Flexo satinado.

26225003	558,00
26225003NM	797,00
26225003BM	797,00
26225003AC	797,00
26225003OR	1.078,00
26225003OM	1.078,00



LLAVES DE PASO

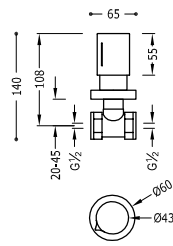

Llave de paso empotrada
Conexión a rosca hembra: 1/2".

06115501	83,00
06115501NM	128,00
06115501BM	128,00
06115501AC	128,00
06115501OR	182,00
06115501OM	182,00

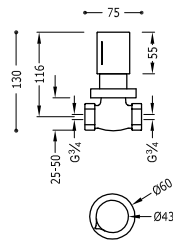

Llave de paso empotrada
Conexión a rosca hembra: 3/4".

06151101	91,00
06151101NM	140,00
06151101BM	140,00
06151101AC	140,00
06151101OR	199,00
06151101OM	199,00





FUJI

Las formas cónicas de la colección Fuji de Tres se representan en cada una de las piezas. Su silueta sinuosa es lo que consigue este dinamismo tan atractivo para los baños modernos y eleva la notoriedad y presencia de cada grifo.







GRIFOS PARA LAVABO

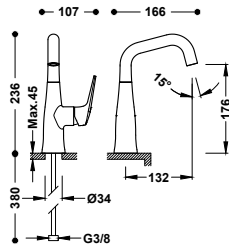

Grifo monomando con maneta lateral para lavabo
Latiguillos de alimentación flexibles G3/8.

■	28144701	210,00
■	28144701NM	326,00
■	28144701AC	326,00
■	28144701OPM	462,00



29902804

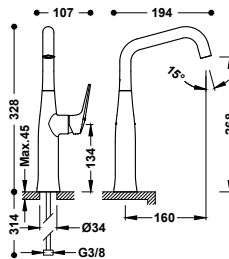

Grifo monomando alto con maneta lateral para lavabo
Latiguillos de alimentación flexibles G3/8.

■	28164701	221,00
■	28164701NM	342,00
■	28164701AC	342,00
■	28164701OPM	485,00



29902804

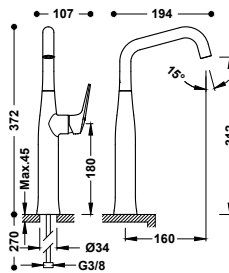

Grifo monomando XXL con maneta lateral para lavabo
Latiguillos de alimentación flexibles G3/8.

■	28184701	236,00
■	28184701NM	366,00
■	28184701AC	366,00
■	28184701OPM	520,00



29902804

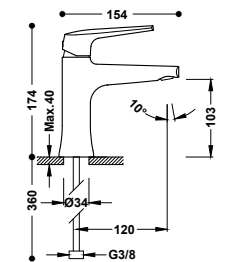

Grifo monomando para lavabo
Latiguillos de alimentación flexibles G3/8.

■	28110301	121,00
■	28110301NM	187,00
■	28110301AC	187,00
■	28110301OPM	266,00



5,7 lpm 29902802

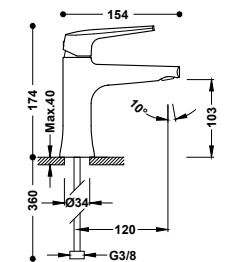

Grifo monomando ecoeficiente para lavabo
Latiguillos de alimentación flexibles G3/8.

■	28110401	129,00
■	28110401NM	200,00
■	28110401AC	200,00
■	28110401OPM	284,00



5,7 lpm 29902808

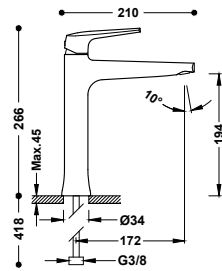

Grifo monomando alto para lavabo
Latiguillos de alimentación flexibles G3/8.

	28120301	236,00
	28120301NM	366,00
	28120301AC	366,00
	28120301OPM	520,00

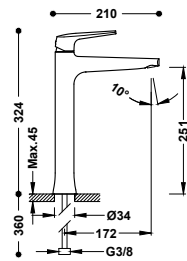

Grifo monomando XXL para lavabo
Latiguillos de alimentación flexibles G3/8.

	28180301	273,00
	28180301NM	423,00
	28180301AC	423,00
	28180301OPM	601,00

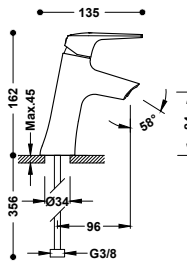

Grifo monomando inclinado para lavabo
Latiguillos de alimentación flexibles G3/8.

	28190301	125,00
	28190301NM	194,00
	28190301AC	194,00
	28190301OPM	275,00

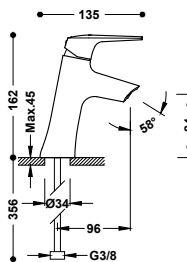

Grifo monomando inclinado ecoeficiente para lavabo
Latiguillos de alimentación flexibles G3/8.

	28110402	133,00
	28110402NM	207,00
	28110402AC	207,00
	28110402OPM	293,00



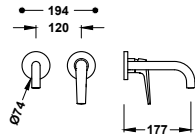

Pieza vista para cuerpo empotrado de lavabo

Solo parte vista. Incluye placa embellecedora, mando y caño de 177 mm. Cuerpo empotrado no incluido.

28130021	145,00
28130021NM	225,00
28130021AC	225,00
28130021OPM	352,00



Cuerpo empotrado para grifo de lavabo

20830002 85,00

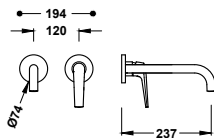

Pieza vista para cuerpo empotrado de lavabo

Solo parte vista. Incluye placa embellecedora, mando y caño de 237 mm. Cuerpo empotrado no incluido.

28130022	155,00
28130022NM	240,00
28130022AC	240,00
28130022OPM	341,00



Cuerpo empotrado para grifo de lavabo

20830002 85,00

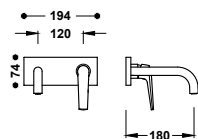

Pieza vista para cuerpo empotrado de lavabo

Solo parte vista. Incluye placa embellecedora, mando y caño de 180 mm. Cuerpo empotrado no incluido.

28130023	185,00
28130023NM	287,00
28130023AC	287,00
28130023OPM	407,00



Cuerpo empotrado para grifo de lavabo

20830002 85,00

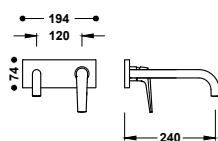

Pieza vista para cuerpo empotrado de lavabo

Solo parte vista. Incluye placa embellecedora, mando y caño de 240 mm. Cuerpo empotrado no incluido.

28130024	195,00
28130024NM	302,00
28130024AC	302,00
28130024OPM	429,00



Cuerpo empotrado para grifo de lavabo

20830002 85,00

GRIFOS PARA BIDÉ

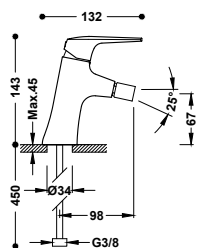

Grifo monomando para bidé

Rótula orientable. Latiguillos de alimentación flexibles G3/8.

28112001	128,00
28112001NM	199,00
28112001AC	199,00
28112001OPM	282,00



29902802

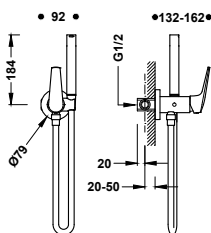

Grifo monomando empotrado con ducha para inodoro

Con agua fría y caliente. Ducha de mano con racor limitador a 5 l/min. y sistema antigoteo. Soporte fijo para la ducha de mano instalable a derecha o izquierda. Flexo satinado.

28112301	180,00
28112301NM	279,00
28112301AC	279,00
28112301OPM	396,00



9134591



Accesorio porta toallas para grifo con ducha para inodoro

Soporte instalable a derecha o izquierda (para ref.: 134122, 134123, 181122, 181123, 181222, 181223, 20522201, 20522301). Long: 180 mm.

03412401	37,00
03412401NM	57,00
03412401AC	57,00
03412401OPM	81,00

GRIFOS MURALES

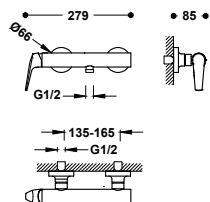

Grifo monomando mural para ducha

Ducha de mano anticalcárea: Ø 110 mm. (3 tipos de chorro). Soporte orientable para ducha de mano. Flexo satinado.

28116701	242,00
28116701NM	374,00
28116701AC	374,00
28116701OPM	531,00



29902802

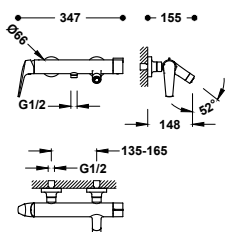

Grifo monomando mural para bañera y ducha

Con inversor integrado. Ducha de mano anticalcárea: Ø 110 mm. (3 tipos de chorro). Soporte orientable para ducha de mano. Flexo satinado.

28117001	263,00
28117001NM	407,00
28117001AC	407,00
28117001OPM	578,00



29903516



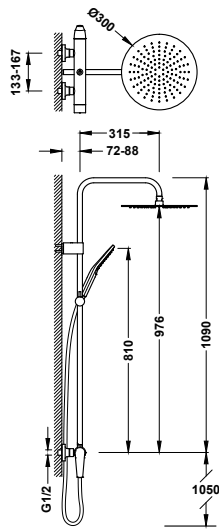

Conjunto de grifo monomando mural de 2 vías para ducha

- Con inversor integrado.
- Rociador de ducha orientable de acero inoxidable: Ø 300 mm.
- Soporte deslizante y orientable para ducha de mano.
- Ducha de mano anticalcárea: Ø 110 mm. (3 tipos de chorro).
- Flexo satinado.

28119101	497,00
28119101NM	770,00
28119101AC	770,00
28119101OPM	1.093,00

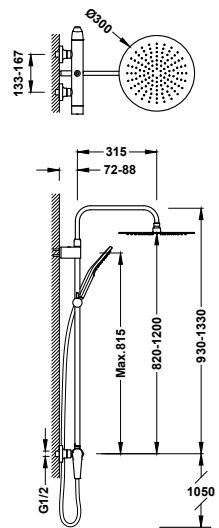

Conjunto de grifo monomando mural de 2 vías para ducha

- Con inversor integrado.
- Rociador de ducha orientable de acero inoxidable: Ø 300 mm.
- Barra de ducha telescópica.
- Soporte deslizante y orientable para ducha de mano.
- Ducha de mano anticalcárea: Ø 110 mm. (3 tipos de chorro).
- Flexo satinado.

28119701	528,00
28119701NM	819,00
28119701AC	819,00
28119701OPM	1.162,00



GRIFOS EMPOTRADOS

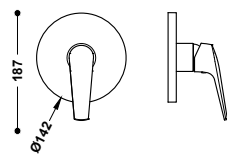

Pieza vista para caja empotrada de 1 vía Rapid-box

Sólo parte vista. Incluye placa embellecedora, mando, casquillo y tornillo de fijación oculto. Completar con la caja empotrada Rapid-box ref.: 20827810.

28127810	79,00
28127810NM	122,00
28127810AC	122,00
28127810OPM	173,00



Caja empotrada de 1 vía Rapid-box con grifo monomando para ducha

20827810	80,00
----------	-------

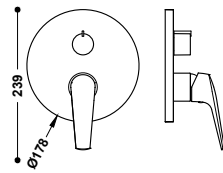

Pieza vista para caja empotrada de 2 vías Rapid-box

Sólo parte vista. Incluye placa embellecedora, mando, volante distribuidor y tornillo de fijación oculto. Completar con la caja empotrada Rapid-box ref.: 20828110.

	28128110	100,00
	28128110NM	155,00
	28128110AC	155,00
	28128110OPM	219,00



Caja empotrada de 2 vías Rapid-box con grifo monomando para ducha y bañera

20828110	90,00
----------	-------

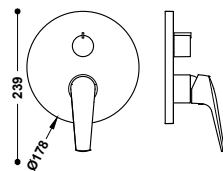

Pieza vista para caja empotrada de 3 vías Rapid-box

Sólo parte vista. Incluye placa embellecedora, mando, volante distribuidor y tornillo de fijación oculto. Completar con la caja empotrada Rapid-box ref.: 20827310.

	28127310	109,00
	28127310NM	169,00
	28127310AC	169,00
	28127310OPM	240,00



Caja empotrada de 3 vías Rapid-box con grifo monomando para ducha y bañera

20827310	95,00
----------	-------

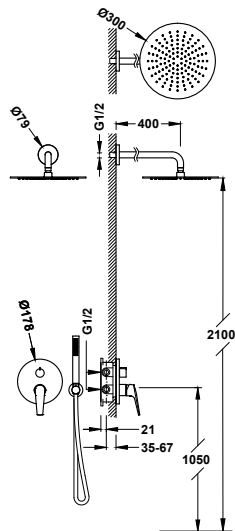

Kit de grifo monomando empotrado de 2 vías Rapid-box para ducha

- Cuerpo empotrado incluido.
- Distribuidor cerámico de 2 vías.
- Brazo a pared con rociador de ducha orientable y de acero inoxidable: Ø 300 mm.
- Soporte para ducha de mano con toma de agua a pared.
- Ducha de mano anticalcárea de latón.
- Flexo satinado.

	28128004	474,00
	28128004NM	691,00
	28128004AC	691,00
	28128004OPM	947,00



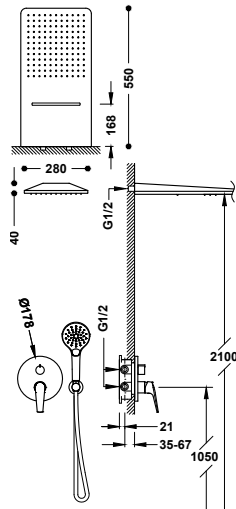

Kit de grifo monomando empotrado de 3 vías Rapid-box para ducha

- Cuerpo empotrado incluido.
- Distribuidor cerámico de 3 vías.
- Rociador de ducha a pared de acero inoxidable con 2 tipos de chorro (lluvia/cascada). 280x550 mm. IMPORTANTE: Montar un desagüe de >50 l/min.
- Soporte para ducha de mano con toma de agua a pared.
- Ducha de mano anticalcárea: Ø 110 mm. (3 tipos de chorro).
- Flexo satinado.

28127301	1.104,00
28127301NM	1.660,00
28127301AC	1.660,00
28127301OPM	2.318,00

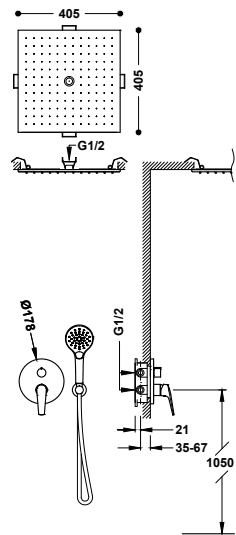

Kit de grifo monomando empotrado de 3 vías Rapid-box para ducha

- Cuerpo empotrado incluido.
- Distribuidor cerámico de 3 vías.
- Rociador de ducha empotrado a techo de acero inoxidable con 2 tipos de chorro (lluvia/free flow). 405x405 mm.
- Soporte para ducha de mano con toma de agua a pared.
- Ducha de mano anticalcárea: Ø 110 mm. (3 tipos de chorro).
- Flexo satinado.

28127302	1.180,00
28127302NM	1.780,00
28127302AC	1.780,00
28127302OPM	2.486,00



GRIFOS TERMOSTÁTICOS MURALES

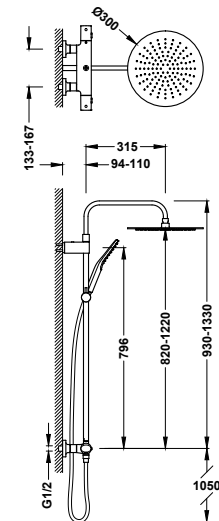

Conjunto de grifo termostático mural Over-wall de 2 vías para ducha

- Con inversor integrado en el regulador de caudal.
- Volante ovalado.
- Barra de ducha telescópica.
- Rociador de ducha orientable de acero inoxidable: Ø 300 mm.
- Soporte deslizante y orientable para ducha de mano.
- Ducha de mano anticalcárea: Ø 110 mm. (3 tipos de chorro).
- Flexo satinado.

19038705	580,00
19038705NM	899,00
19038705AC	899,00
19038705OPM	1.276,00



GRIFOS TERMOSTÁTICOS EMPOTRADOS

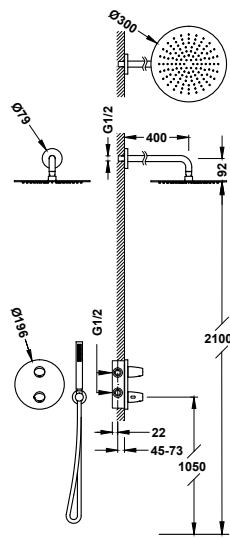

Kit de grifo termostático empotrado de 2 vías
Therm-box para ducha

- Cuerpo empotrado incluido.
- Volante ovalado con control de temperatura. Distribuidor cerámico de 2 vías.
- Brazo a pared con rociador de ducha orientable y de acero inoxidable: Ø 300 mm.
- Soporte para ducha de mano con toma de agua a pared.
- Ducha de mano anticalcárea de latón.
- Flexo satinado.

28125004	566,00
28125004NM	806,00
28125004AC	806,00
28125004OPM	1.092,00



29926828

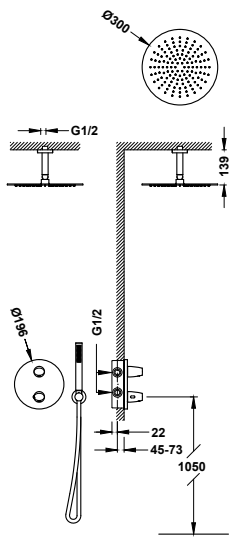

Kit de grifo termostático empotrado de 2 vías
Therm-box para ducha

- Cuerpo empotrado incluido.
- Volante ovalado con control de temperatura. Distribuidor cerámico de 2 vías.
- Brazo a techo con rociador de ducha orientable y de acero inoxidable: Ø 300 mm.
- Soporte para ducha de mano con toma de agua a pared.
- Ducha de mano anticalcárea de latón.
- Flexo satinado.

28125003	538,00
28125003NM	766,00
28125003AC	766,00



29926828

LLAVES DE PASO

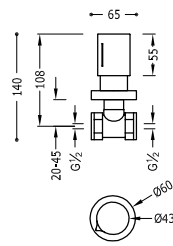

Llave de paso empotrada
Conexión a rosca hembra: 1/2".

06115501	83,00
06115501NM	128,00
06115501AC	128,00
06115501OPM	182,00

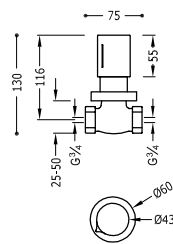

Llave de paso empotrada
Conexión a rosca hembra: 3/4".

06151101	91,00
06151101NM	140,00
06151101AC	140,00
06151101OPM	199,00





PROJECT-TRES

Project-tres es la serie más especial de Tres. Adaptable a muchos entornos y con acabados sorprendentes, esta serie mezcla la innovación tecnológica con el diseño más versátil. Por algo será que a todo el mundo le gusta.

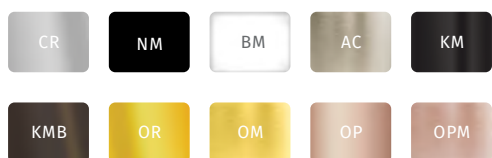





GRIFOS PARA LAVABO

Grifo monomando para lavabo

Latiguillos de alimentación flexibles G3/8.

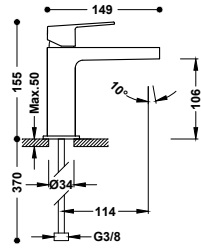

21110301	111,00
21110301D	134,00
21110301NM	173,00
21110301BM	173,00
21110301AC	173,00
21110301KM	173,00
21110301KMB	173,00
21110301OR	245,00
21110301OM	245,00
21110301OP	245,00
21110301OPM	245,00

Grifo monomando alto para lavabo

Latiguillos de alimentación flexibles G3/8.

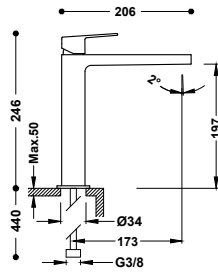

21120301	233,00
21120301NM	361,00
21120301BM	361,00
21120301AC	361,00
21120301KM	361,00
21120301KMB	361,00
21120301OR	513,00
21120301OM	513,00
21120301OP	513,00
21120301OPM	513,00

Grifo monomando XXL para lavabo

Latiguillos de alimentación flexibles G3/8.

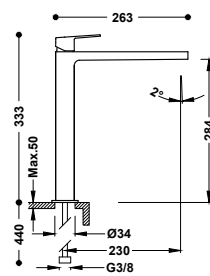

21180301	268,00
21180301NM	415,00
21180301BM	415,00
21180301AC	415,00
21180301KM	415,00
21180301KMB	415,00
21180301OR	589,00
21180301OM	589,00
21180301OP	589,00
21180301OPM	589,00

Grifo monomando para lavabo

Latiguillos de alimentación flexibles G3/8.

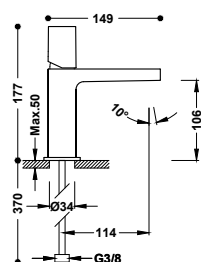

21110302	111,00
21110302D	134,00
21110302NM	173,00
21110302BM	173,00
21110302AC	173,00
21110302KM	173,00
21110302KMB	173,00
21110302OR	245,00
21110302OM	245,00
21110302OP	245,00
21110302OPM	245,00

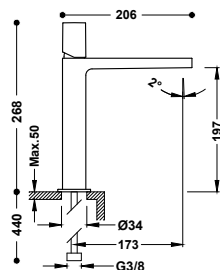

Grifo monomando alto para lavabo
Latiguillos de alimentación flexibles G3/8.



21120302	233,00
21120302NM	361,00
21120302BM	361,00
21120302AC	361,00
21120302KM	361,00
21120302KMB	361,00
21120302OR	513,00
21120302OM	513,00
21120302OP	513,00
21120302OPM	513,00

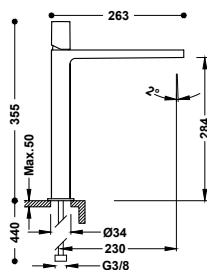

Grifo monomando XXL para lavabo
Latiguillos de alimentación flexibles G3/8.



21180302	268,00
21180302NM	415,00
21180302BM	415,00
21180302AC	415,00
21180302KM	415,00
21180302KMB	415,00
21180302OR	589,00
21180302OM	589,00
21180302OP	589,00
21180302OPM	589,00

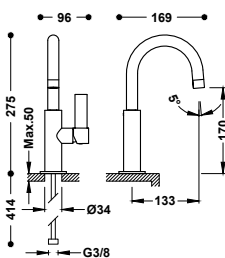

Grifo monomando con maneta lateral para lavabo
Latiguillos de alimentación flexibles G3/8.



21190401	208,00
21190401NM	322,00
21190401BM	322,00
21190401AC	322,00
21190401KM	322,00
21190401KMB	322,00
21190401OR	457,00
21190401OM	457,00
21190401OP	457,00
21190401OPM	457,00

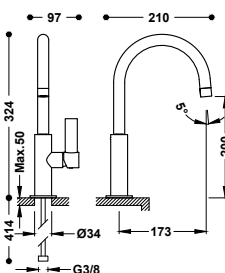

Grifo monomando alto con maneta lateral para lavabo
Latiguillos de alimentación flexibles G3/8.



21190501	218,00
21190501NM	339,00
21190501BM	339,00
21190501AC	339,00
21190501KM	339,00
21190501KMB	339,00
21190501OR	480,00
21190501OM	480,00
21190501OP	480,00
21190501OPM	480,00

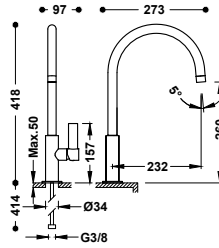

Grifo monomando XXL con maneta lateral para lavabo
Latiguillos de alimentación flexibles G3/8.

21190601	229,00
21190601NM	355,00
21190601BM	355,00
21190601AC	355,00
21190601KM	355,00
21190601KMB	355,00
21190601OR	504,00
21190601OM	504,00
21190601OP	504,00
21190601OPM	504,00

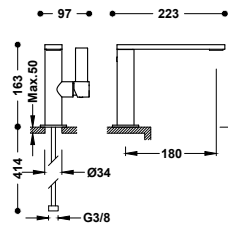

Grifo monomando con maneta lateral para lavabo
Latiguillos de alimentación flexibles G3/8.

21120501	184,00
21120501NM	285,00
21120501BM	285,00
21120501AC	285,00
21120501KM	285,00
21120501KMB	285,00
21120501OR	404,00
21120501OM	404,00
21120501OP	404,00
21120501OPM	404,00

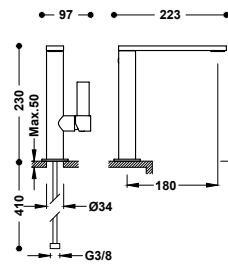

Grifo monomando alto con maneta lateral para lavabo
Latiguillos de alimentación flexibles G3/8.

21130501	205,00
21130501NM	317,00
21130501BM	317,00
21130501AC	317,00
21130501KM	317,00
21130501KMB	317,00
21130501OR	450,00
21130501OM	450,00
21130501OP	450,00
21130501OPM	450,00

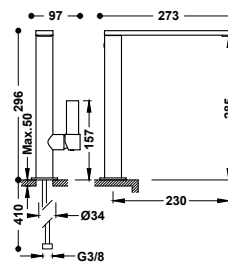

Grifo monomando XXL con maneta lateral para lavabo
Latiguillos de alimentación flexibles G3/8.

21140501	226,00
21140501NM	350,00
21140501BM	350,00
21140501AC	350,00
21140501KM	350,00
21140501KMB	350,00
21140501OR	497,00
21140501OM	497,00
21140501OP	497,00
21140501OPM	497,00



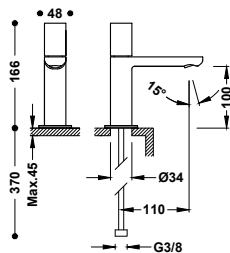

Grifo de 1 agua para lavabo
Con latiguillo de alimentación flexible G3/8.



21150301	105,00
21150301NM	163,00
21150301BM	163,00
21150301AC	163,00
21150301KM	163,00
21150301KMB	163,00
21150301OR	231,00
21150301OM	231,00
21150301OP	231,00
21150301OPM	231,00

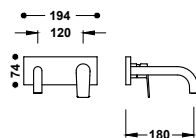

Pieza vista para cuerpo empotrado de lavabo
Solo parte vista. Incluye placa embellecedora, mando y caño de 180 mm. Cuerpo empotrado no incluido.



21130031	175,00
21130031NM	271,00
21130031BM	271,00
21130031AC	271,00
21130031KM	271,00
21130031KMB	271,00
21130031OR	385,00
21130031OM	385,00
21130031OP	385,00
21130031OPM	385,00



Cuerpo empotrado para grifo de lavabo	20830002	85,00
---------------------------------------	----------	-------

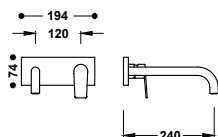

Pieza vista para cuerpo empotrado de lavabo
Solo parte vista. Incluye placa embellecedora, mando y caño de 240 mm. Cuerpo empotrado no incluido.



21130032	185,00
21130032NM	287,00
21130032BM	287,00
21130032AC	287,00
21130032KM	287,00
21130032KMB	287,00
21130032OR	407,00
21130032OM	407,00
21130032OP	407,00
21130032OPM	407,00



Cuerpo empotrado para grifo de lavabo	20830002	85,00
---------------------------------------	----------	-------

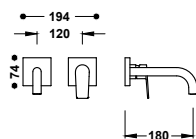

Pieza vista para cuerpo empotrado de lavabo
Solo parte vista. Incluye placa embellecedora, mando y caño de 180 mm. Cuerpo empotrado no incluido.



21130021	140,00
21130021NM	217,00
21130021BM	217,00
21130021AC	217,00
21130021KM	217,00
21130021KMB	217,00
21130021OR	308,00
21130021OM	308,00
21130021OP	308,00
21130021OPM	308,00



Cuerpo empotrado para grifo de lavabo	20830002	85,00
---------------------------------------	----------	-------

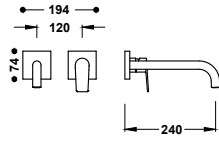

Pieza vista para cuerpo empotrado de lavabo

Solo parte vista. Incluye placa embellecedora, mando y caño de 240 mm. Cuerpo empotrado no incluido.



21130022	150,00
21130022NM	233,00
21130022BM	233,00
21130022AC	233,00
21130022KM	233,00
21130022KMB	233,00
21130022OR	330,00
21130022OM	330,00
21130022OP	330,00
21130022OPM	330,00



Cuerpo empotrado para grifo de lavabo

20830002	85,00
----------	-------

GRIFOS PARA BIDÉ

Grifo monomando para bidé

Rótula orientable. Latiguillos de alimentación flexibles G3/8.

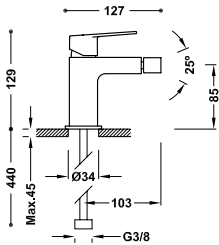

21112001	114,00
21112001D	138,00
21112001NM	177,00
21112001BM	177,00
21112001AC	177,00
21112001KM	177,00
21112001KMB	177,00
21112001OR	252,00
21112001OM	252,00
21112001OP	252,00
21112001OPM	252,00

Grifo monomando para bidé

Rótula orientable. Latiguillos de alimentación flexibles G3/8.

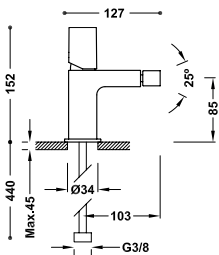

21112002	114,00
21112002D	138,00
21112002NM	177,00
21112002BM	177,00
21112002AC	177,00
21112002KM	177,00
21112002KMB	177,00
21112002OR	252,00
21112002OM	252,00
21112002OP	252,00
21112002OPM	252,00

Grifo monomando con maneta lateral para bidé

Rótula orientable. Latiguillos de alimentación flexibles G3/8.

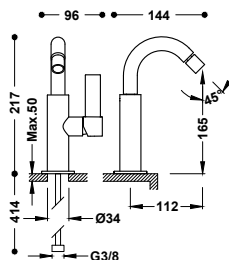

21122401	200,00
21122401NM	309,00
21122401BM	309,00
21122401AC	309,00
21122401KM	309,00
21122401KMB	309,00
21122401OR	439,00
21122401OM	439,00
21122401OP	439,00
21122401OPM	439,00

GRIFOS MURALES

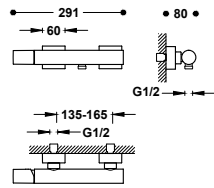

Grifo monomando mural para ducha

Ducha de mano anticalcárea de latón. Soporte orientable para ducha de mano. Flexo satinado.

21116701	231,00
21116701NM	358,00
21116701BM	358,00
21116701AC	358,00
21116701KM	358,00
21116701KMB	358,00
21116701OR	508,00
21116701OM	508,00
21116701OP	508,00
21116701OPM	508,00

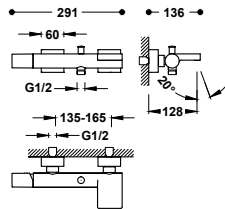

Grifo monomando mural para bañera y ducha

Con salida de agua en cascada. Ducha de mano anticalcárea de latón. Soporte orientable para ducha de mano. Flexo satinado.

21117001	252,00
21117001NM	391,00
21117001BM	391,00
21117001AC	391,00
21117001KM	391,00
21117001KMB	391,00
21117001OR	554,00
21117001OM	554,00
21117001OP	554,00
21117001OPM	554,00



GRIFOS EMPOTRADOS

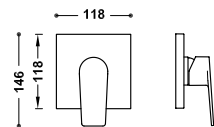

Pieza vista para caja empotrada de 1 vía Rapid-box

Sólo parte vista. Incluye placa embellecedora, mando, casquillo y tornillo de fijación oculto. Completar con la caja empotrada Rapid-box ref.: 20827810.

21127810	79,00
21127810NM	122,00
21127810BM	122,00
21127810AC	122,00
21127810KM	122,00
21127810KMB	122,00
21127810OR	173,00
21127810OM	173,00
21127810OP	173,00
21127810OPM	173,00



Caja empotrada de 1 vía Rapid-box con grifo monomando para ducha

20827810	80,00
----------	-------

Pieza vista para caja empotrada de 2 vías Rapid-box

Sólo parte vista. Incluye placa embellecedora, mando, volante distribuidor y tornillo de fijación oculto. Completar con la caja empotrada Rapid-box ref.: 20828110.

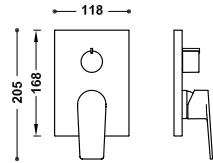

21128110	100,00
21128110NM	155,00
21128110BM	155,00
21128110AC	155,00
21128110KM	155,00
21128110KMB	155,00
21128110OR	219,00
21128110OM	219,00
21128110OP	219,00
21128110OPM	219,00



Caja empotrada de 2 vías Rapid-box con grifo monomando para ducha y bañera

20828110	90,00
----------	-------

Kit de grifo monomando empotrado de 2 vías Rapid-box para ducha

- Cuerpo empotrado incluido.
- Distribuidor cerámico de 2 vías.
- Brazo a pared con rociador de ducha orientable y de acero inoxidable: 300x300 mm.
- Soporte para ducha de mano con toma de agua a pared.
- Ducha de mano anticalcárea de latón.
- Flexo satinado.

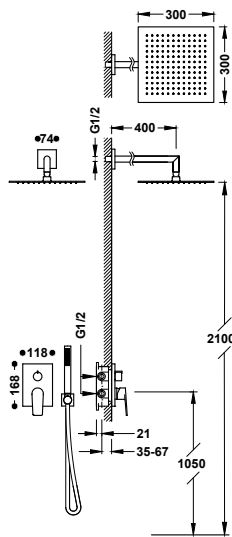

21128004	540,00
21128004NM	787,00
21128004BM	787,00
21128004AC	787,00
21128004KM	787,00
21128004KMB	787,00
21128004OR	1.081,00
21128004OM	1.081,00
21128004OP	1.081,00
21128004OPM	1.081,00

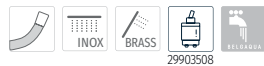

Kit de grifo monomando empotrado de 2 vías Rapid-box para ducha

- Cuerpo empotrado incluido.
- Distribuidor cerámico de 2 vías.
- Rociador de ducha a pared de acero inoxidable: 160x550 mm.
- Soporte para ducha de mano con toma de agua a pared.
- Ducha de mano anticalcárea de latón.
- Flexo satinado.

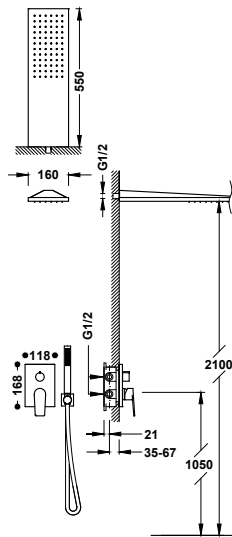

21128005	731,00
21128005NM	1.085,00
21128005BM	1.085,00
21128005AC	1.085,00
21128005KM	1.085,00
21128005KMB	1.085,00
21128005OR	1.504,00
21128005OM	1.504,00
21128005OP	1.504,00
21128005OPM	1.504,00

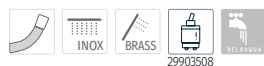

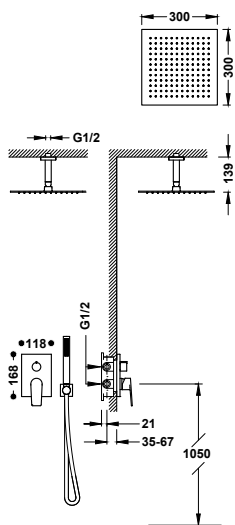

**Kit de grifo monomando empotrado de 2 vías
Rapid-box para ducha**

- Cuerpo empotrado incluido.
- Distribuidor cerámico de 2 vías.
- Brazo a techo con rociador de ducha orientable y de acero inoxidable: 300x300 mm.
- Soporte para ducha de mano con toma de agua a pared.
- Ducha de mano anticalcárea de latón.
- Flexo satinado.

21128003	506,00
21128003NM	735,00
21128003BM	735,00
21128003AC	735,00
21128003KM	735,00
21128003KMB	735,00
21128003OR	1.007,00
21128003OM	1.007,00
21128003OP	1.007,00
21128003OPM	1.007,00

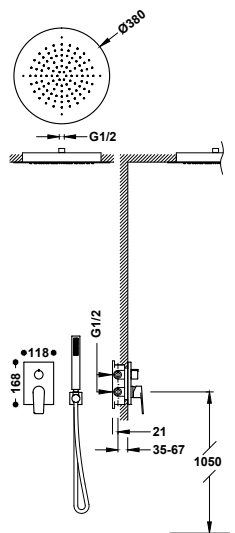
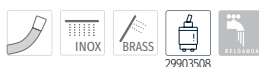

**Kit de grifo monomando empotrado de 2 vías
Rapid-box para ducha**

- Cuerpo empotrado incluido.
- Distribuidor cerámico de 2 vías.
- Rociador de ducha empotrado a techo de acero inoxidable: Ø 380 mm.
- Soporte para ducha de mano con toma de agua a pared.
- Ducha de mano anticalcárea de latón.
- Flexo satinado.

21128006	1.086,00
21128006NM	1.634,00
21128006BM	1.634,00
21128006AC	1.634,00
21128006KM	1.634,00
21128006KMB	1.634,00
21128006OR	2.282,00
21128006OM	2.282,00
21128006OP	2.282,00
21128006OPM	2.282,00

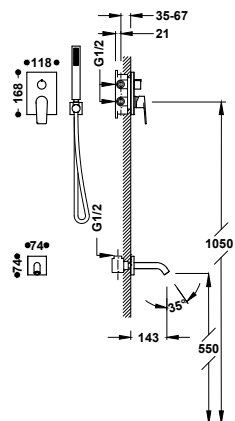
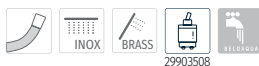

**Kit de grifo monomando empotrado de 2 vías
Rapid-box para bañera y ducha**

- Cuerpo empotrado incluido.
- Distribuidor cerámico de 2 vías.
- Caño fijo de bañera a pared.
- Soporte para ducha de mano con toma de agua a pared.
- Ducha de mano anticalcárea de latón.
- Flexo satinado.

21128007	394,00
21128007NM	560,00
21128007BM	560,00
21128007AC	560,00
21128007KM	560,00
21128007KMB	560,00
21128007OR	758,00
21128007OM	758,00
21128007OP	758,00
21128007OPM	758,00

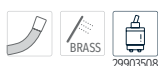

GRIFOS PARA BAÑERA

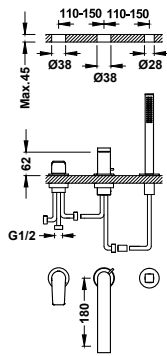

Grifo monomando para borde de bañera

- Inversor integrado en el caño de bañera.
- Ducha de mano anticalcárea de latón.
- Caño de bañera de 180 mm. Caudal: 3 bar - 13 l/min.
- Kit depósito opcional no incluido ref.: 20024501.

21116101	370,00
21116101NM	574,00
21116101BM	574,00
21116101AC	574,00
21116101KM	574,00
21116101KMB	574,00
21116101OR	814,00
21116101OM	814,00
21116101OP	814,00
21116101OPM	814,00



Depósito para grifería de borde de bañera

20024501	415,00
----------	--------



Válvula de desagüe Click-clack para bañera con rebosadero y toma de drenaje

134445	100,00
--------	--------

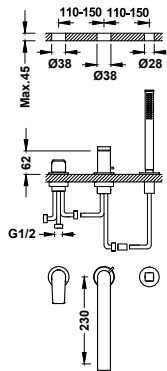

Grifo monomando para borde de bañera

- Inversor integrado en el caño de bañera.
- Ducha de mano anticalcárea de latón.
- Caño de bañera de 230 mm. Caudal: 3 bar - 13 l/min.
- Kit depósito opcional no incluido ref.: 20024501.

21116103	380,00
21116103NM	589,00
21116103BM	589,00
21116103AC	589,00
21116103KM	589,00
21116103KMB	589,00
21116103OR	836,00
21116103OM	836,00
21116103OP	836,00
21116103OPM	836,00



Depósito para grifería de borde de bañera

20024501	415,00
----------	--------



Válvula de desagüe Click-clack para bañera con rebosadero y toma de drenaje

134445	100,00
--------	--------

GRIFOS TERMOSTÁTICOS MURALES

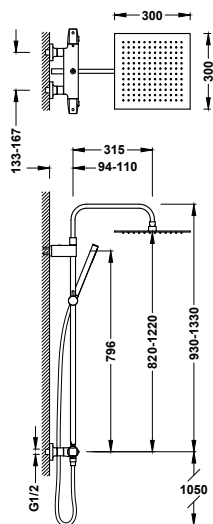

Conjunto de grifo termostático mural Over-wall de 2 vías para ducha

- Con inversor integrado en el regulador de caudal.
- Volante cuadrado-redondo.
- Barra de ducha telescópica.
- Rociador de ducha orientable de acero inoxidable: 300x300 mm.
- Soporte deslizante y orientable para ducha de mano.
- Ducha de mano anticalcárea de latón.
- Flexo satinado.

19039307	596,00
19039307NM	924,00
19039307BM	924,00
19039307AC	924,00
19039307KMB	924,00
19039307OM	1.311,00
19039307OPM	1.311,00



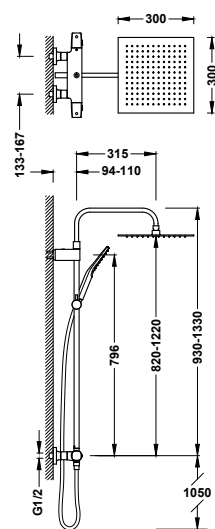

Conjunto de grifo termostático mural Over-wall de 2 vías para ducha

- Con inversor integrado en el regulador de caudal.
- Volante con bordes redondeados.
- Barra de ducha telescópica.
- Rociador de ducha orientable de acero inoxidable: 300x300 mm.
- Soporte deslizante y orientable para ducha de mano.
- Ducha de mano anticalcárea: 96x110 mm. (3 tipos de chorro).
- Flexo satinado.

19038702	609,00
19038702NM	944,00
19038702BM	944,00
19038702AC	944,00
19038702KMB	944,00
19038702OM	1.340,00
19038702OPM	1.340,00



GRIFOS TERMOSTÁTICOS EMPOTRADOS

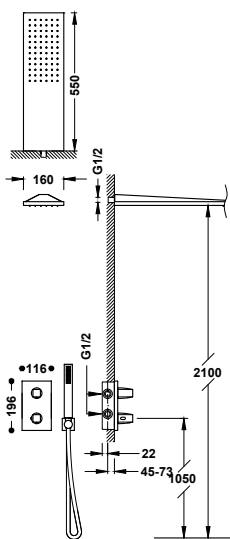

Kit de grifo termostático empotrado de 2 vías Therm-box para ducha

- Cuerpo empotrado incluido.
- Volante cuadrado-redondo con control de temperatura.
- Distribuidor cerámico de 2 vías.
- Rociador de ducha a pared de acero inoxidable: 160x550 mm.
- Soporte para ducha de mano con toma de agua a pared.
- Ducha de mano anticalcárea de latón.
- Flexo satinado.

21125005	785,00
21125005NM	1.147,00
21125005BM	1.147,00
21125005AC	1.147,00
21125005KM	1.147,00
21125005KMB	1.147,00
21125005OR	1.575,00
21125005OM	1.575,00
21125005OP	1.575,00
21125005OPM	1.575,00

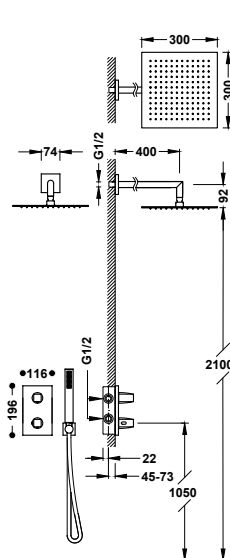

Kit de grifo termostático empotrado de 2 vías Therm-box para ducha

- Cuerpo empotrado incluido.
- Volante cuadrado-redondo con control de temperatura.
- Distribuidor cerámico de 2 vías.
- Brazo a pared con rociador de ducha orientable y de acero inoxidable: 300x300 mm.
- Soporte para ducha de mano con toma de agua a pared.
- Ducha de mano anticalcárea de latón.
- Flexo satinado.

21125004	595,00
21125004NM	849,00
21125004BM	849,00
21125004AC	849,00
21125004KM	849,00
21125004KMB	849,00
21125004OR	1.153,00
21125004OM	1.153,00
21125004OP	1.153,00
21125004OPM	1.153,00

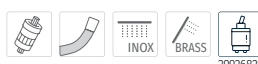

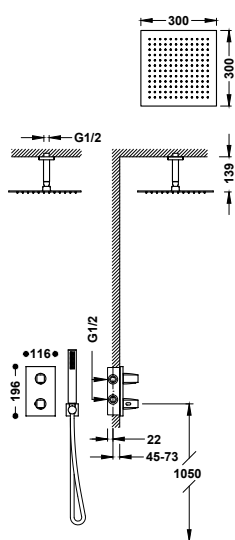

**Kit de grifo termostático empotrado de 2 vías
Therm-box para ducha**

- Cuerpo empotrado incluido.
- Volante cuadrado-redondo con control de temperatura.
- Distribuidor cerámico de 2 vías.
- Brazo a techo con rociador de ducha orientable y de acero inoxidable: 300x300 mm.
- Soporte para ducha de mano con toma de agua a pared.
- Ducha de mano anticalcárea de latón.
- Flexo satinado.

21125003	566,00
21125003NM	805,00
21125003BM	805,00
21125003AC	805,00
21125003KM	805,00
21125003KMB	805,00
21125003OR	1.089,00
21125003OM	1.089,00
21125003OP	1.089,00
21125003OPM	1.089,00





MAX

El cuidado estético junto con toda la tecnología desarrollada para su creación sitúan Max entre las series más elegantes y funcionales que aportan modernidad, sencillez y calidad al baño.







GRIFOS PARA LAVABO

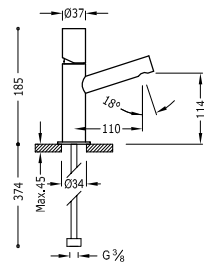

Grifo monomando para lavabo

Latiguillos de alimentación flexibles G3/8.

■ 06110301 109,00
 ■ 06110301D 132,00

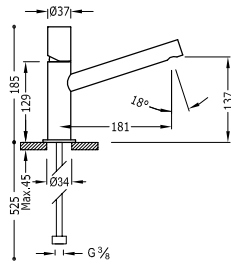

Grifo monomando para lavabo

Caño largo. Latiguillos de alimentación flexibles G3/8.

■ 06120301 125,00
 ■ 06120301D 148,00

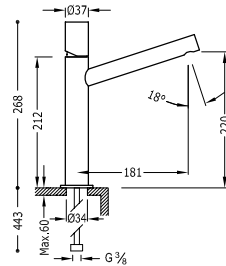

Grifo monomando alto para lavabo

Caño largo. Latiguillos de alimentación flexibles G3/8.

■ 06120601 217,00

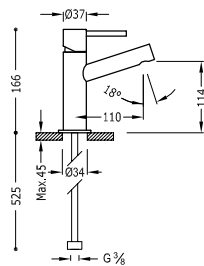

Grifo monomando para lavabo

Latiguillos de alimentación flexibles G3/8.

■ 06210301 109,00
 ■ 06210301D 132,00

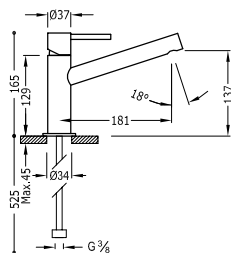

Grifo monomando para lavabo

Caño largo. Latiguillos de alimentación flexibles G3/8.

■ 06220301 125,00
 ■ 06220301D 148,00



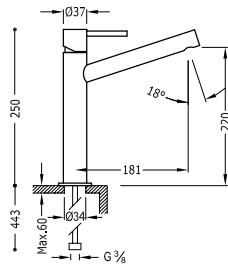

Grifo monomando alto para lavabo

Caño largo. Latiguillos de alimentación flexibles G3/8.

06220601

217,00



910719005

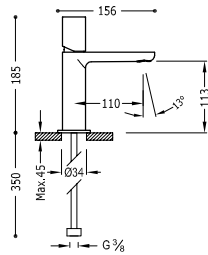

Grifo monomando para lavabo

Latiguillos de alimentación flexibles G3/8.

06110302

127,00

06110302D

150,00



9130190

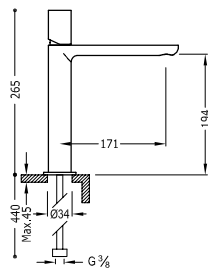

Grifo monomando alto para lavabo

Latiguillos de alimentación flexibles G3/8.

06120304

217,00



9130190

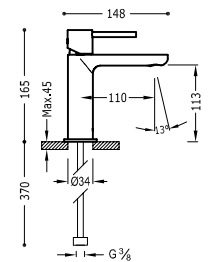

Grifo monomando para lavabo

Latiguillos de alimentación flexibles G3/8.

06210302

127,00

06210302D

150,00



9130190

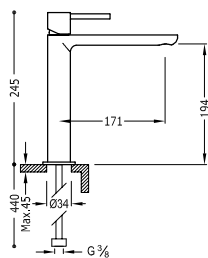

Grifo monomando alto para lavabo

Latiguillos de alimentación flexibles G3/8.

06220304

217,00



9130190

Pieza vista para cuerpo empotrado de lavabo

06230031

155,00

Solo parte vista. Incluye placa embellecedora, mando y caño de 180 mm. Cuerpo empotrado no incluido.

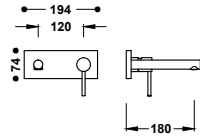

Cuerpo empotrado para grifo de lavabo

20830002

85,00

Pieza vista para cuerpo empotrado de lavabo

06230032

165,00

Solo parte vista. Incluye placa embellecedora, mando y caño de 240 mm. Cuerpo empotrado no incluido.

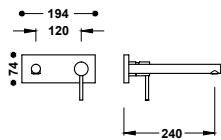

Cuerpo empotrado para grifo de lavabo

20830002

85,00

Pieza vista para cuerpo empotrado de lavabo

06230021

135,00

Solo parte vista. Incluye placa embellecedora, mando y caño de 177 mm. Cuerpo empotrado no incluido.

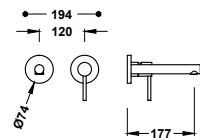

Cuerpo empotrado para grifo de lavabo

20830002

85,00

Pieza vista para cuerpo empotrado de lavabo

06230022

145,00

Solo parte vista. Incluye placa embellecedora, mando y caño de 237 mm. Cuerpo empotrado no incluido.

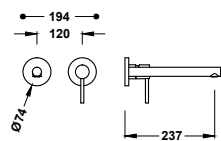

Cuerpo empotrado para grifo de lavabo

20830002

85,00

GRIFOS PARA BIDÉ

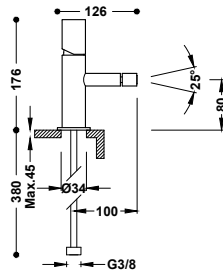

Grifo monomando para bidé

Rótula orientable. Latiguillos de alimentación flexibles G3/8.

- 06112001 112,00
- 06112001D 135,00

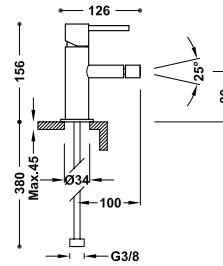

Grifo monomando para bidé

Rótula orientable. Latiguillos de alimentación flexibles G3/8.

- 06212001 112,00
- 06212001D 135,00

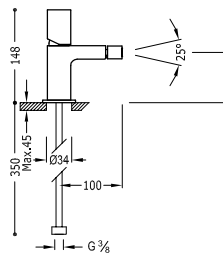

Grifo monomando para bidé

Rótula orientable. Latiguillos de alimentación flexibles G3/8.

- 06122001 130,00
- 06122001D 153,00

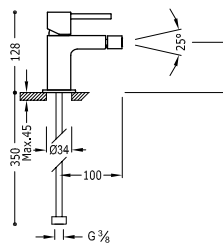

Grifo monomando para bidé

Rótula orientable. Latiguillos de alimentación flexibles G3/8.

- 06222001 130,00
- 06222001D 153,00

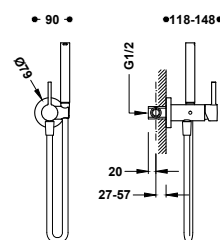

Grifo monomando empotrado con ducha para inodoro

Con agua fría y caliente. Ducha de mano con racor limitador a 5 l/min. y sistema antigoteo. Soporte fijo para la ducha de mano instalable a derecha o izquierda. Flexo satinado.

- 134123 190,00



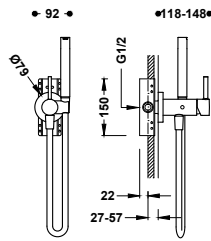

Grifo monomando empotrado con ducha para inodoro
 Opción para paredes de Pladur. Con agua fría y caliente. Ducha de mano con racor limitador a 5 l/min. y sistema antigoteo. Soporte fijo para la ducha de mano instalable a derecha o izquierda. Flexo satinado.

134122 230,00



9134591



Accesorio porta toallas para grifo con ducha para inodoro

03412401 37,00

Soporte instalable a derecha o izquierda (para ref.: 134122, 134123, 181122, 181123, 181222, 181223, 20522201, 20522301). Long: 180 mm.

GRIFOS MURALES

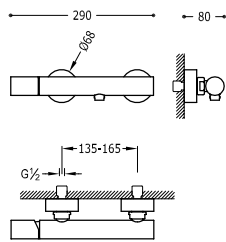

Grifo monomando mural para ducha

06116701 215,00

Ducha de mano anticalcárea. Soporte orientable para ducha de mano. Flexo satinado.



9130190

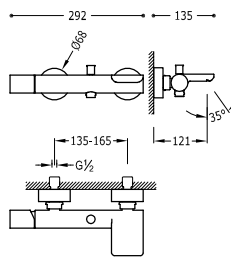

Grifo monomando mural para bañera y ducha

06117001 236,00

Ducha de mano anticalcárea. Caño cerrado con salida del agua en cascada. Soporte orientable para ducha de mano. Flexo satinado.



9130190

GRIFOS EMPOTRADOS

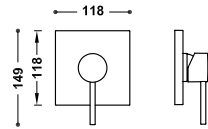

Pieza vista para caja empotrada de 1 vía Rapid-box

06227810

79,00

Sólo parte vista. Incluye placa embellecedora, mando, casquillo y tornillo de fijación oculto. Completar con la caja empotrada Rapid-box ref: 20827810.



Caja empotrada de 1 vía Rapid-box con grifo monomando para ducha

20827810

80,00

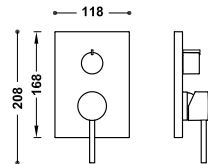

Pieza vista para caja empotrada de 2 vías Rapid-box

06228110

100,00

Sólo parte vista. Incluye placa embellecedora, mando, volante distribuidor y tornillo de fijación oculto. Completar con la caja empotrada Rapid-box ref: 20828110.



Caja empotrada de 2 vías Rapid-box con grifo monomando para ducha y bañera

20828110

90,00

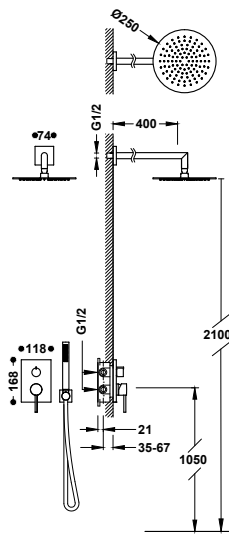

Kit de grifo monomando empotrado de 2 vías Rapid-box para ducha

06228004

427,00

- Cuerpo empotrado incluido.
- Distribuidor cerámico de 2 vías.
- Brazo a pared con rociador de ducha orientable y de acero inoxidable: Ø 250 mm.
- Soporte para ducha de mano con toma de agua a pared.
- Ducha de mano anticalcárea de latón.
- Flexo satinado.



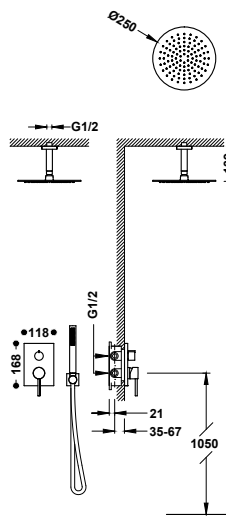

**Kit de grifo monomando empotrado de 2 vías
Rapid-box para ducha**

06228003

387,00

- Cuerpo empotrado incluido.
- Distribuidor cerámico de 2 vías.
- Brazo a techo con rociador de ducha orientable y de acero inoxidable: Ø 250 mm.
- Soporte para ducha de mano con toma de agua a pared.
- Ducha de mano anticalcárea de latón.
- Flexo satinado.

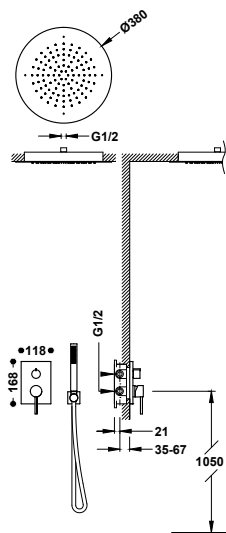

**Kit de grifo monomando empotrado de 2 vías
Rapid-box para ducha**

06228005

888,00

- Cuerpo empotrado incluido.
- Distribuidor cerámico de 2 vías.
- Rociador empotrado a techo de acero inoxidable: Ø 380 mm.
- Soporte para ducha de mano con toma de agua a pared.
- Ducha de mano anticalcárea de latón.
- Flexo satinado.

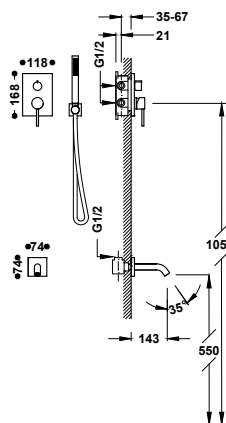

**Kit de grifo monomando empotrado de 2 vías
Rapid-box para bañera y ducha**

06228006

335,00

- Cuerpo empotrado incluido.
- Distribuidor cerámico de 2 vías.
- Caño fijo de bañera a pared.
- Soporte para ducha de mano con toma de agua a pared.
- Ducha de mano anticalcárea de latón.
- Flexo satinado.

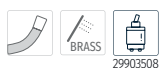

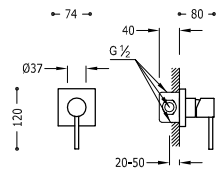
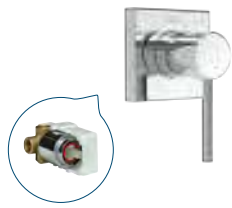

Grifo monomando empotrado de 1 vía para ducha
Cuerpo empotrado incluido.

06217702

116,00



9130190

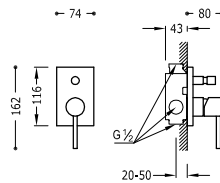

Grifo monomando empotrado de 2 vías para bañera y ducha

06218002

179,00

Cuerpo empotrado incluido. Inversor de 2 vías.



9130190

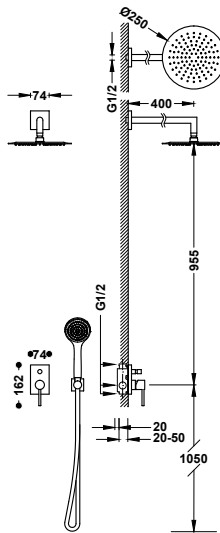

Kit de grifo monomando empotrado de 2 vías para ducha

06298004

442,00

- Cuerpo empotrado incluido.
- Inversor de 2 vías.
- Brazo a pared con rociador de ducha orientable y de acero inoxidable: Ø 250 mm.
- Soporte para ducha de mano con toma de agua a pared.
- Ducha de mano anticalcárea.
- Flexo satinado.



9130190

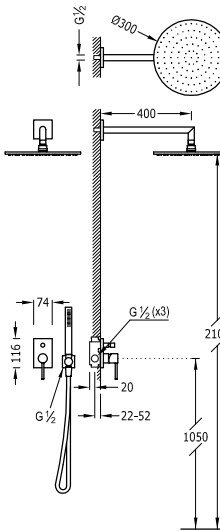

Kit de grifo monomando empotrado de 2 vías para ducha

06298001

513,00

- Cuerpo empotrado incluido.
- Inversor de 2 vías.
- Brazo a pared con rociador de ducha orientable y de acero inoxidable: Ø 300 mm.
- Soporte para ducha de mano con toma de agua a pared.
- Ducha de mano anticalcárea de latón.
- Flexo satinado.

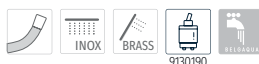

9130190



Kit de grifo monomando empotrado de 2 vías para ducha

06218081

414,00

- Cuerpo empotrado incluido.
- Inversor de 2 vías.
- Brazo a techo con rociador de ducha orientable y de acero inoxidable: Ø 250 mm.
- Soporte para ducha de mano con toma de agua a pared.
- Ducha de mano anticalcárea.
- Flexo satinado.

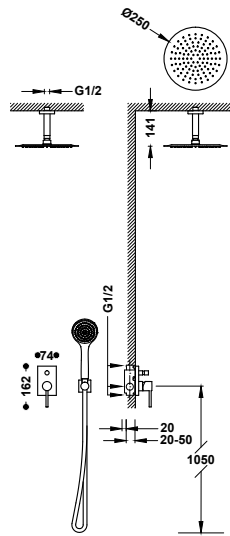

Kit de grifo monomando empotrado de 2 vías para ducha

06218080

479,00

- Cuerpo empotrado incluido.
- Inversor de 2 vías.
- Brazo a techo con rociador de ducha orientable y de acero inoxidable: Ø 300 mm.
- Soporte para ducha de mano con toma de agua a pared.
- Ducha de mano anticalcárea de latón.
- Flexo satinado.

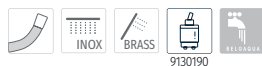
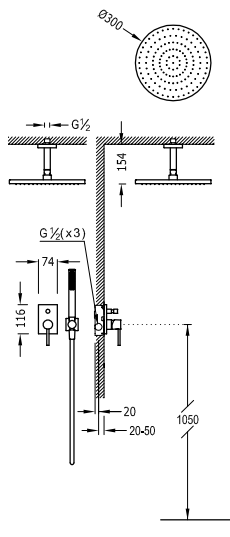

GRIFOS PARA BAÑERA



Grifo monomando para borde de bañera

06216103

350,00

- Inversor integrado en el caño de bañera.
- Ducha de mano anticalcárea de latón.
- Caño de bañera de 180 mm. Caudal: 3 bar - 16 l/m.
- Kit depósito opcional no incluido ref.: 20324501.

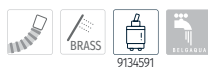
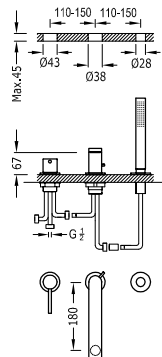

Depósito para grifería de borde de bañera

20324501

415,00



Válvula de desagüe Click-clack para bañera con rebosadero y toma de drenaje

134445

100,00

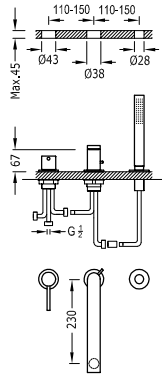

Grifo monomando para borde de bañera

06216102

360,00

- Inversor integrado en el caño de bañera.
- Ducha de mano anticalcárea de latón.
- Caño de bañera de 230 mm. Caudal: 3 bar - 16 l/m.
- Kit depósito opcional no incluido ref.: 20324501.

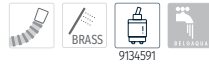

Depósito para grifería de borde de bañera

20324501

415,00



Válvula de desagüe Click-clack para bañera con rebosadero y toma de drenaje

134445

100,00

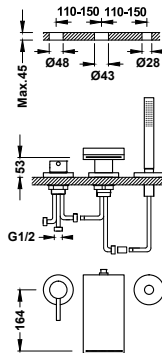

Grifo monomando para borde de bañera

162161

790,00

- Inversor integrado en el caño de bañera.
- Ducha de mano anticalcárea de latón.
- Caño de bañera con salida del agua en cascada. Caudal: 3 bar - 17 l/m.
- Kit depósito opcional no incluido ref.: 162245.



Depósito para grifería de borde de bañera

162245

415,00



Válvula de desagüe Click-clack para bañera con rebosadero y toma de drenaje

134445

100,00

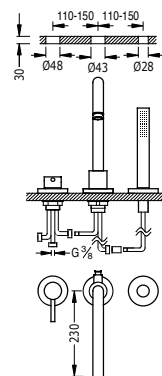

Grifo monomando para borde de bañera

26215001

450,00

- Inversor integrado en el caño de bañera.
- Ducha de mano anticalcárea de latón.
- Caudal: 3 bar - 14 l/min.
- Kit depósito opcional no incluido ref.: 162245.



Depósito para grifería de borde de bañera

162245

415,00



Válvula de desagüe Click-clack para bañera con rebosadero y toma de drenaje

134445

100,00

GRIFOS TERMOSTÁTICOS MURALES

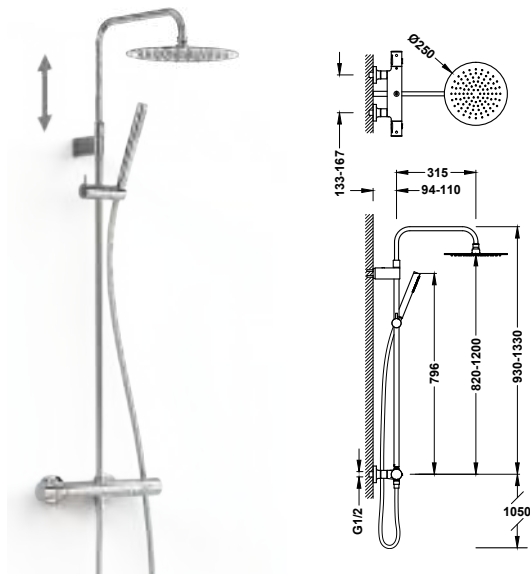

Conjunto de grifo termostático mural Over-wall de 2 vías para ducha

19038708

489,00

- Con inversor integrado en el regulador de caudal.
- Barra de ducha telescópica.
- Volante redondo.
- Rociador de ducha orientable de acero inoxidable: Ø250 mm.
- Soporte deslizante y orientable para ducha de mano.
- Ducha de mano anticalcárea de latón.
- Flexo satinado.

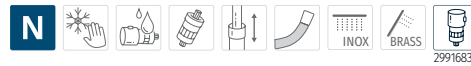

GRIFOS TERMOSTÁTICOS EMPOTRADOS

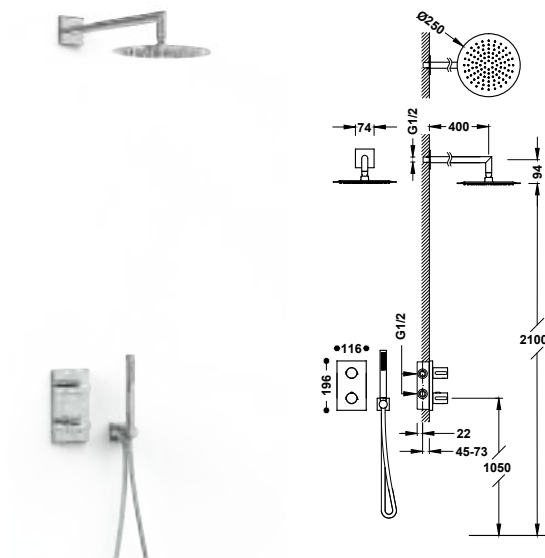

Kit de grifo termostático empotrado de 2 vías Therm-box para ducha

06225004

515,00

- Cuerpo empotrado incluido.
- Volante redondo con control de temperatura. Distribuidor cerámico de 2 vías.
- Brazo a pared con rociador de ducha orientable y de acero inoxidable: Ø 250 mm.
- Soporte para ducha de mano con toma de agua a pared.
- Ducha de mano anticalcárea de latón.
- Flexo satinado.

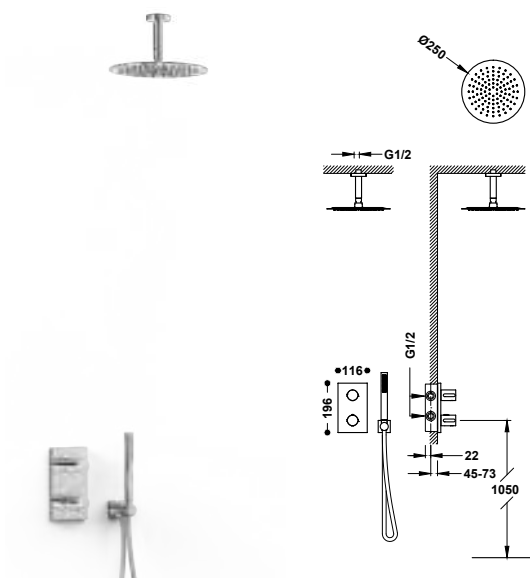

Kit de grifo termostático empotrado de 2 vías Therm-box para ducha

06225003

480,00

- Cuerpo empotrado incluido.
- Volante redondo con control de temperatura. Distribuidor cerámico de 2 vías.
- Brazo a techo con rociador de ducha orientable y de acero inoxidable: Ø 250 mm.
- Soporte para ducha de mano con toma de agua a pared.
- Ducha de mano anticalcárea de latón.
- Flexo satinado.





LEX-ALP

Un diseño clásico que invita a la calma. Lex-Alp es una serie equilibrada, que funciona a la perfección y nunca pasa de moda. Eso es lo que la hace más especial.





GRIFOS PARA LAVABO

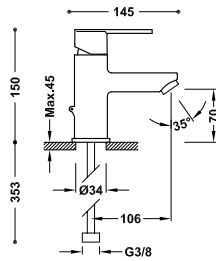

Grifo monomando para lavabo

Con aireador de fácil limpieza. Latiguillos de alimentación flexibles G3/8.

■	181103	109,00
■	186103	132,00

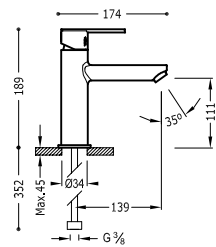

Grifo monomando para lavabo

Con aireador de fácil limpieza. Latiguillos de alimentación flexibles G3/8.

■	181203	135,00
■	186203	159,00

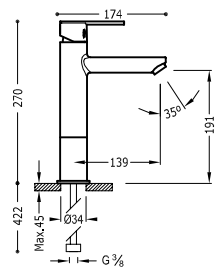

Grifo monomando alto para lavabo

Con aireador de fácil limpieza. Latiguillos de alimentación flexibles G3/8.

■	181217	214,00
■	186217	237,00

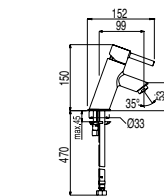

Grifo monomando inclinado para lavabo

Latiguillos de alimentación flexibles G3/8.

■	20310301	88,00
■	20310301D	111,00

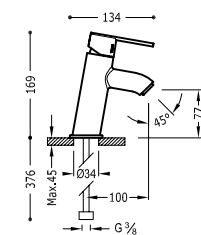

Grifo monomando inclinado para lavabo

Con aireador de fácil limpieza. Latiguillos de alimentación flexibles G3/8.

■	181903	113,00
---	--------	--------



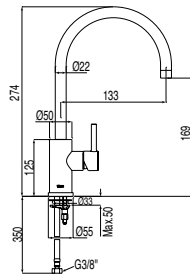

Grifo monomando con maneta lateral para lavabo
Latiguillos de alimentación flexibles G3/8.

20370301

168,00

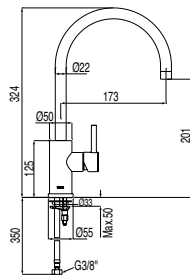

Grifo monomando alto con maneta lateral para lavabo
Latiguillos de alimentación flexibles G3/8.

20340301

179,00

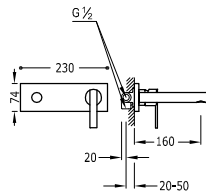

Grifo monomando empotrado para lavabo

08120001

242,00

Cuerpo empotrado incluido e indivisible. Caño de 160 mm.

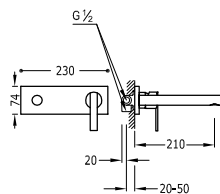

Grifo monomando empotrado para lavabo

08120021

252,00

Cuerpo empotrado incluido e indivisible. Caño de 210 mm.

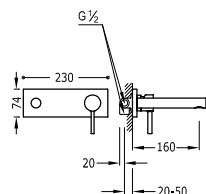

Grifo monomando empotrado para lavabo

20321001

242,00

Cuerpo empotrado incluido e indivisible. Caño de 160 mm.



Grifo monomando empotrado para lavabo

■ 20320002

252,00

Cuerpo empotrado incluido e indivisible. Caño de 210 mm.

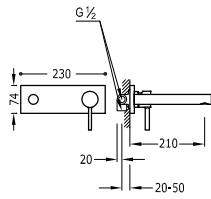

GRIFOS PARA BIDÉ

Grifo monomando para bidé

■ 181120

112,00

Rótula orientable. Con aireador de fácil limpieza. Latiguillos de alimentación flexibles G3/8.

■ 186120

135,00

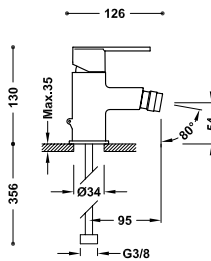

Grifo monomando inclinado para bidé

■ 181920

117,00

Rótula orientable. Con aireador de fácil limpieza. Latiguillos de alimentación flexibles G3/8.

■ 186920

140,00

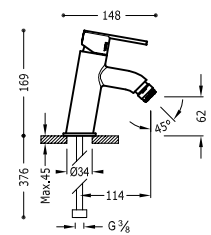

Grifo monomando inclinado para bidé

■ 20312001

91,00

Rótula orientable. Latiguillos de alimentación flexibles G3/8.

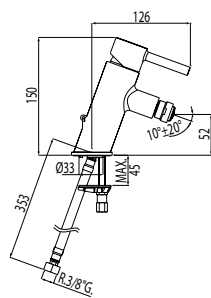

Grifo monomando con maneta lateral para bidé

■ 20322401

171,00

Rótula orientable. Latiguillos de alimentación flexibles G3/8.

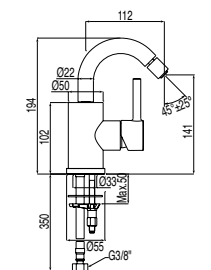

9134592

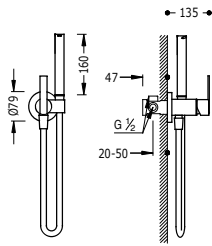

Grifo monomando empotrado con ducha para inodoro

181223

182,00

Con agua fría y caliente. Ducha de mano con racor limitador a 5 l/min. y sistema antigoteo. Soporte fijo para la ducha de mano instalable a derecha o izquierda. Flexo satinado.



9134591

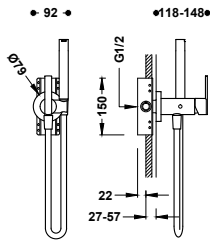

Grifo monomando empotrado con ducha para inodoro

181222

227,00

Opción para paredes de Pladur. Con agua fría y caliente. Ducha de mano con racor limitador a 5 l/min. y sistema antigoteo. Soporte fijo para la ducha de mano instalable a derecha o izquierda. Flexo satinado.



9134591



Accesorio porta toallas para grifo con ducha para inodoro

03412401

37,00

Soporte instalable a derecha o izquierda (para ref.: 134122, 134123, 181122, 181123, 181222, 181223, 20522201, 20522301). Long: 180 mm.

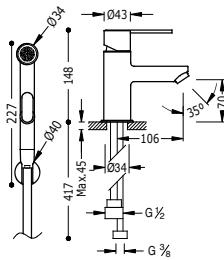

Grifo monomando para lavabo con ducha para inodoro

181113

194,00

Ducha de mano anticalcárea con cierre de caudal. Soporte fijo para ducha de mano. Flexo satinado. Latiguillos de alimentación flexibles G3/8.



913459210

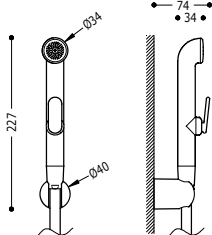

Kit de ducha para grifo monomando para inodoro

29995001

38,00

Ducha de mano con cierre de caudal. Soporte fijo para ducha de mano. Flexo satinado. Atención: Recambio solo para bidé ref: 181113.



GRIFOS MURALES

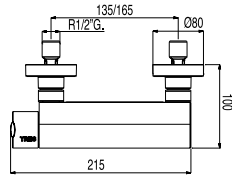

Grifo monomando mural para ducha

181468

173,00

Ducha de mano anticalcárea: Ø 100 mm. (5 tipos de chorro).
Soporte orientable para ducha de mano. Flexo satinado.

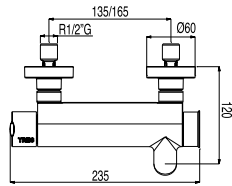

Grifo monomando mural para bañera y ducha

181474

194,00

Ducha de mano anticalcárea: Ø 100 mm. (5 tipos de chorro).
Soporte orientable para ducha de mano. Flexo satinado.

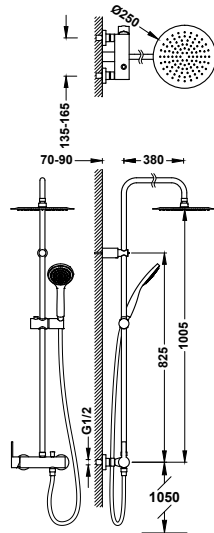

Conjunto de grifo monomando mural de 2 vías para ducha

18119102

412,00

- Rociador de ducha orientable de acero inoxidable: Ø 250 mm.
- Soporte deslizante y orientable para ducha de mano.
- Ducha de mano anticalcárea: Ø 100 mm.
- Flexo satinado.

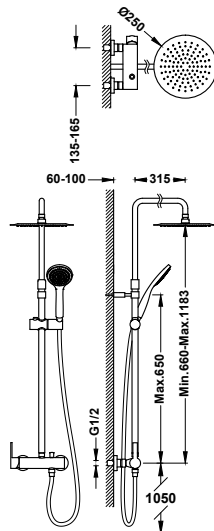

Conjunto de grifo monomando mural de 2 vías para ducha

08119703

470,00

- Rociador de ducha orientable de acero inoxidable: Ø 250 mm.
- Barra de ducha telescópica.
- Soporte deslizante y orientable para ducha de mano.
- Ducha de mano anticalcárea: Ø 100 mm.
- Flexo satinado.



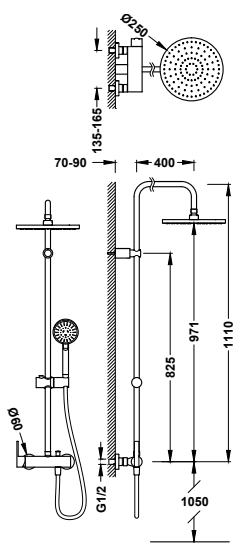

Conjunto de grifo monomando mural de 2 vías para ducha

181191

412,00

- Rociador de ducha orientable de acero inoxidable: Ø 250 mm.
- Soporte deslizante y orientable para ducha de mano.
- Ducha de mano anticalcárea: Ø 100 mm. (5 tipos de chorro).
- Flexo satinado.

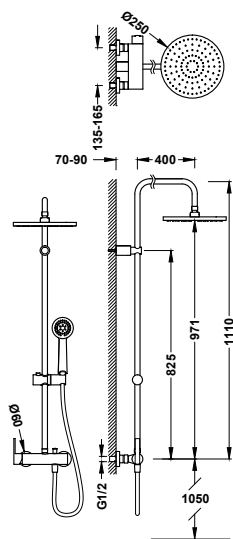

Conjunto de grifo monomando mural de 2 vías para ducha

081192

399,00

- Rociador de ducha orientable de acero inoxidable: Ø 250 mm.
- Soporte deslizante y orientable para ducha de mano.
- Ducha de mano anticalcárea: Ø 100 mm.
- Flexo metálico reforzado.

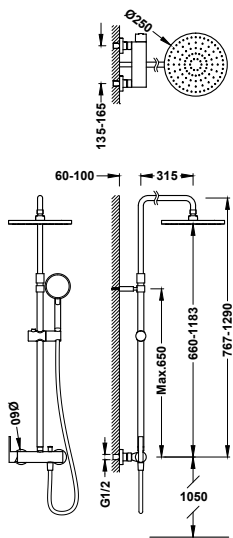

Conjunto de grifo monomando mural de 2 vías para ducha

08119702

475,00

- Rociador de ducha orientable de acero inoxidable: Ø 250 mm.
- Barra de ducha telescópica.
- Soporte deslizante y orientable para ducha de mano.
- Ducha de mano anticalcárea: Ø 100 mm. (5 tipos de chorro).
- Flexo satinado.



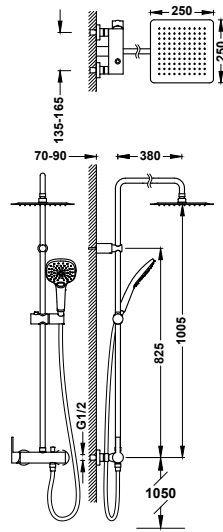

Conjunto de grifo monomando mural de 2 vías para ducha

08119302

433,00

- Rociador de ducha orientable de acero inoxidable: 250x250 mm.
- Soporte deslizante y orientable para ducha de mano.
- Ducha de mano anticalcárea: 120x120 mm. (3 tipos de chorro).
- Flexo satinado.

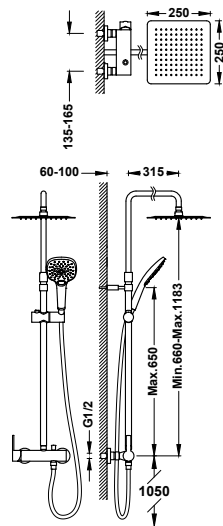

Conjunto de grifo monomando mural de 2 vías para ducha

08119704

497,00

- Rociador de ducha orientable de acero inoxidable: 250x250 mm.
- Barra de ducha telescópica.
- Soporte deslizante y orientable para ducha de mano.
- Ducha de mano anticalcárea: 120x120 mm. (3 tipos de chorro).
- Flexo satinado.

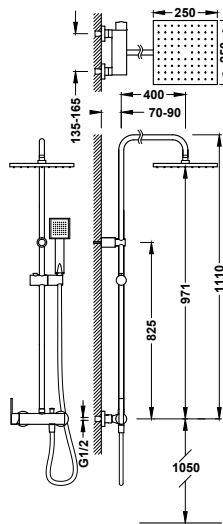

Conjunto de grifo monomando mural de 2 vías para ducha

08119301

425,00

- Rociador de ducha orientable de acero inoxidable: 250x250 mm.
- Soporte deslizante y orientable para ducha de mano.
- Ducha de mano anticalcárea: 80x80 mm.
- Flexo satinado.



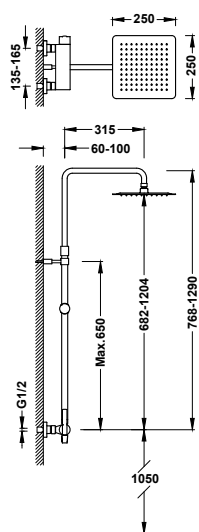

Conjunto de grifo monomando mural de 2 vías para ducha

08119701

451,00

- Rociador de ducha orientable de acero inoxidable: 250x250 mm.
- Barra de ducha telescópica.
- Soporte deslizante y orientable para ducha de mano.
- Ducha de mano anticalcárea.
- Flexo satinado.



GRIFOS EMPOTRADOS

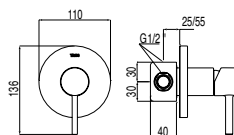

Grifo monomando empotrado de 1 vía para ducha

20317701

100,00

Cuerpo empotrado incluido.

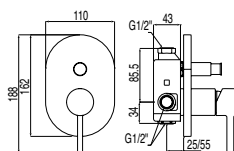

Grifo monomando empotrado de 2 vías para bañera y ducha

20318001

152,00

Cuerpo empotrado incluido. Inversor de 2 vías.

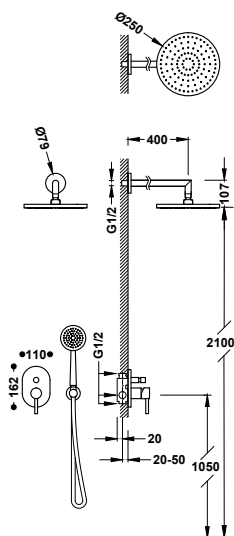

Kit de grifo monomando empotrado de 2 vías para ducha

20318002

401,00

- Cuerpo empotrado incluido.
- Inversor de 2 vías.
- Brazo a pared con rociador de ducha orientable y de acero inoxidable: Ø 250 mm.
- Soporte para ducha de mano con toma de agua a pared.
- Ducha de mano anticalcárea: Ø 100 mm.
- Flexo satinado.



GRIFOS PARA BAÑERA

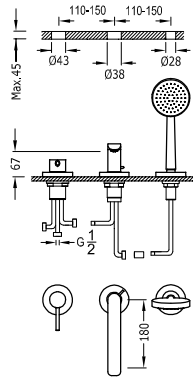

Grifo monomando para borde de bañera

20316102 330,00

- Inversor integrado en el caño de bañera.
- Ducha de mano anticalcárea: Ø 100 mm.
- Caño de bañera de 180 mm. Caudal: 3 bar - 16 l/m.
- Kit depósito opcional no incluido ref.: 20324501.



Depósito para grifería de borde de bañera

20324501 415,00



Válvula de desagüe Click-clack para bañera con rebosadero y toma de drenaje

134445 100,00

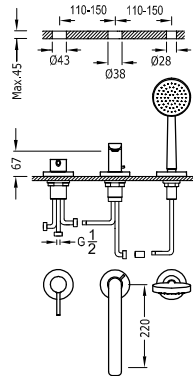

Grifo monomando para borde de bañera

20316101 340,00

- Inversor integrado en el caño de bañera.
- Ducha de mano anticalcárea: Ø 100 mm.
- Caño de bañera de 220 mm. Caudal: 3 bar - 16 l/m.
- Kit depósito opcional no incluido ref.: 20324501.



Depósito para grifería de borde de bañera

20324501 415,00



Válvula de desagüe Click-clack para bañera con rebosadero y toma de drenaje

134445 100,00

GRIFOS TERMOSTÁTICOS MURALES

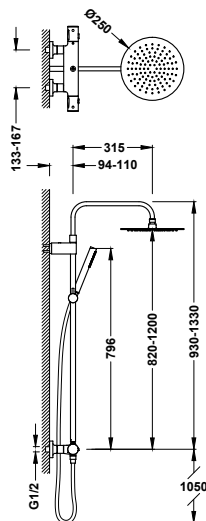

Conjunto de grifo termostático mural Over-wall de 2 vías para ducha

19038708 489,00

- Con inversor integrado en el regulador de caudal.
- Barra de ducha telescópica.
- Volante redondo.
- Rociador de ducha orientable de acero inoxidable: Ø250 mm.
- Soporte deslizante y orientable para ducha de mano.
- Ducha de mano anticalcárea de latón.
- Flexo satinado.

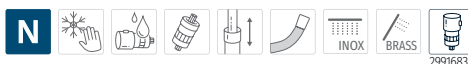

GRIFOS TERMOSTÁTICOS EMPOTRADOS

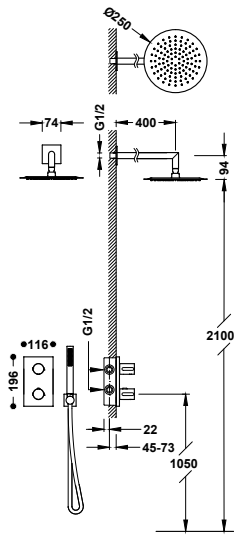

Kit de grifo termostático empotrado de 2 vías
Therm-box para ducha

06225004

515,00

- Cuerpo empotrado incluido.
- Volante redondo con control de temperatura. Distribuidor cerámico de 2 vías.
- Brazo a pared con rociador de ducha orientable y de acero inoxidable: Ø 250 mm.
- Soporte para ducha de mano con toma de agua a pared.
- Ducha de mano anticalcárea de latón.
- Flexo satinado.



LLAVES DE PASO

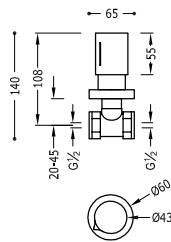

Llave de paso empotrada

06115501

83,00

Conexión a rosca hembra: 1/2".

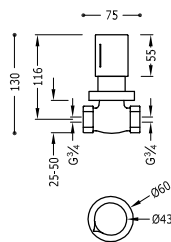

Llave de paso empotrada

06151101

91,00

Conexión a rosca hembra: 3/4".



CLASS

La serie Class nace con el claro objetivo de ofrecer todo el bienestar y confort posible en el cuarto de baño. Es una serie de líneas actuales que encaja a la perfección en todo tipo de espacios, tanto reducidos como amplios.







GRIFOS PARA LAVABO

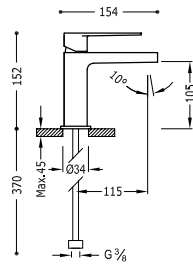

Grifo monomando para lavabo

Latiguillos de alimentación flexibles G3/8.

20510301 107,00
 20510301D 130,00

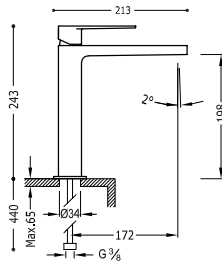

Grifo monomando alto para lavabo

Latiguillos de alimentación flexibles G3/8.

20510303 210,00

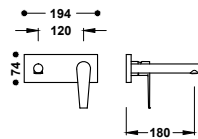

Pieza vista para cuerpo empotrado de lavabo

Solo parte vista. Incluye placa embellecedora, mando y caño de 180 mm. Cuerpo empotrado no incluido.

20530031 125,00



Cuerpo empotrado para grifo de lavabo

20830002 85,00

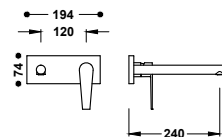

Pieza vista para cuerpo empotrado de lavabo

Solo parte vista. Incluye placa embellecedora, mando y caño de 240 mm. Cuerpo empotrado no incluido.

20530032 135,00



Cuerpo empotrado para grifo de lavabo

20830002 85,00

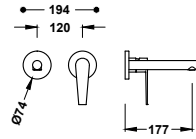

Pieza vista para cuerpo empotrado de lavabo

20530021

135,00

Solo parte vista. Incluye placa embellecedora, mando y caño de 177 mm. Cuerpo empotrado no incluido.



Cuerpo empotrado para grifo de lavabo

20830002

85,00

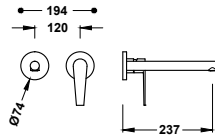

Pieza vista para cuerpo empotrado de lavabo

20530022

145,00

Solo parte vista. Incluye placa embellecedora, mando y caño de 237 mm. Cuerpo empotrado no incluido.



Cuerpo empotrado para grifo de lavabo

20830002

85,00

GRIFOS PARA BIDÉ

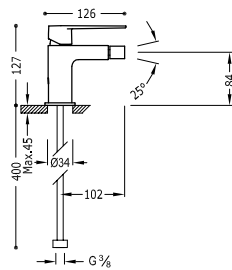

Grifo monomando para bidé

20512001

110,00

Rótula orientable. Latiguillos de alimentación flexibles G3/8.

20512001D

133,00



GRIFOS MURALES

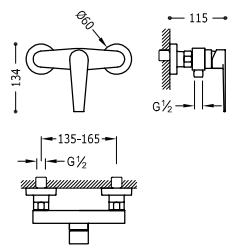

Grifo monomando mural para ducha

20516701

137,00

Ducha de mano anticálcarea. Soporte orientable para ducha de mano. Flexo satinado.

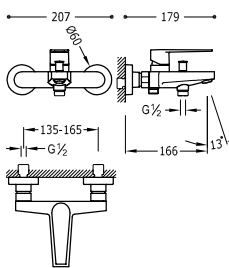

Grifo monomando mural para bañera y ducha

20517001

158,00

Ducha de mano anticálcarea. Soporte orientable para ducha de mano. Flexo satinado.



GRIFOS EMPOTRADOS

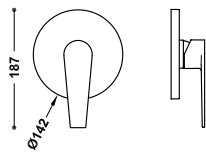

Pieza vista para caja empotrada de 1 vía Rapid-box

20527810

79,00

Sólo parte vista. Incluye placa embellecedora, mando, casquillo y tornillo de fijación oculto. Completar con la caja empotrada Rapid-box ref.: 20827810.



Caja empotrada de 1 vía Rapid-box con grifo monomando para ducha

20827810

80,00

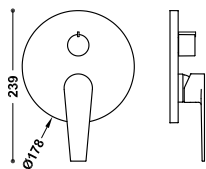

Pieza vista para caja empotrada de 2 vías Rapid-box

20528110

100,00

Sólo parte vista. Incluye placa embellecedora, mando, volante distribuidor y tornillo de fijación oculto. Completar con la caja empotrada Rapid-box ref.: 20828110.



Caja empotrada de 2 vías Rapid-box con grifo monomando para ducha y bañera

20828110

90,00

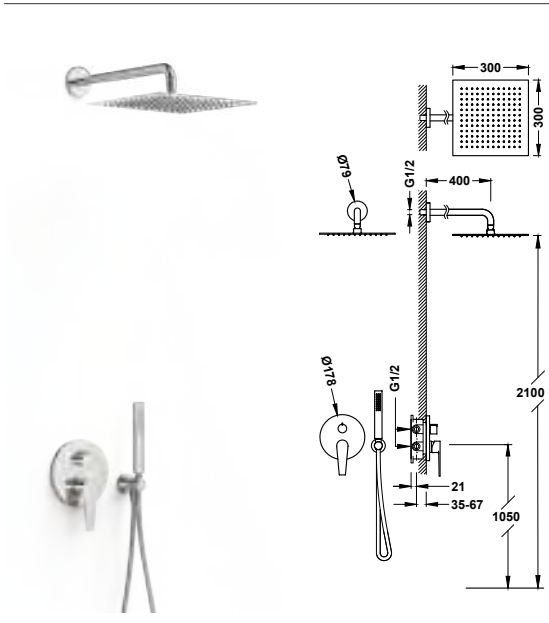

**Kit de grifo monomando empotrado de 2 vías
Rapid-box para ducha**

20528004

452,00

- Cuerpo empotrado incluido.
- Distribuidor cerámico de 2 vías.
- Brazo a pared con rociador de ducha orientable y de acero inoxidable: 300x300 mm.
- Soporte para ducha de mano con toma de agua a pared.
- Ducha de mano anticalcárea.
- Flexo satinado.

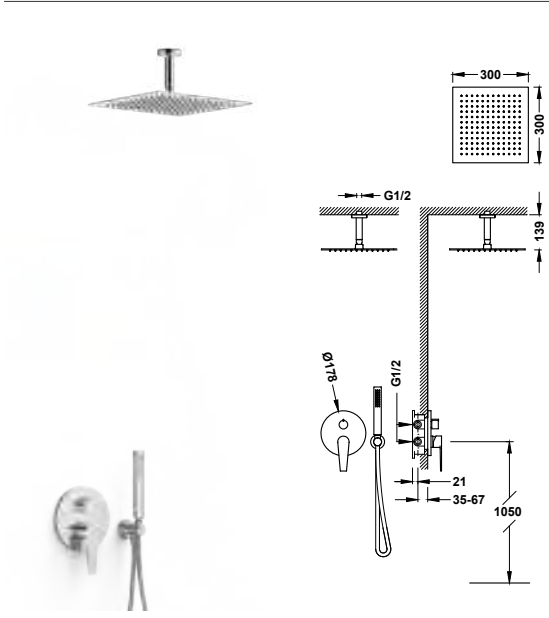

**Kit de grifo monomando empotrado de 2 vías
Rapid-box para ducha**

20528003

428,00

- Cuerpo empotrado incluido.
- Distribuidor cerámico de 2 vías.
- Brazo a techo con rociador de ducha orientable y de acero inoxidable: 300x300 mm.
- Soporte para ducha de mano con toma de agua a pared.
- Ducha de mano anticalcárea.
- Flexo satinado.

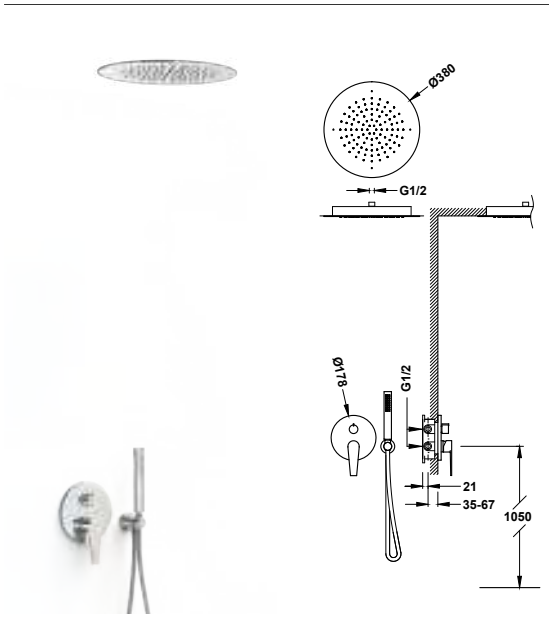

**Kit de grifo monomando empotrado de 2 vías
Rapid-box para ducha**

20528005

905,00

- Cuerpo empotrado incluido.
- Distribuidor cerámico de 2 vías.
- Rociador de ducha empotrado a techo de acero inoxidable: Ø 380 mm.
- Soporte para ducha de mano con toma de agua a pared.
- Ducha de mano anticalcárea.
- Flexo satinado.

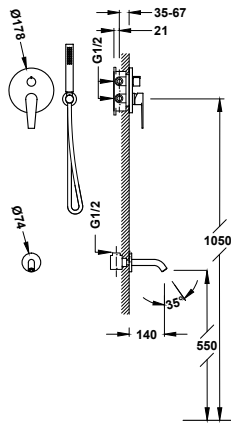

Kit de grifo monomando empotrado de 2 vías Rapid-box para bañera y ducha

20528006 335,00

- Cuerpo empotrado incluido.
- Distribuidor cerámico de 2 vías.
- Caño fijo de bañera a pared.
- Soporte para ducha de mano con toma de agua a pared.
- Ducha de mano anticalcárea.
- Flexo satinado.

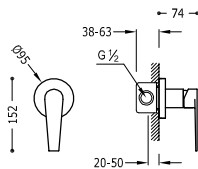

Grifo monomando empotrado de 1 vía para ducha

20517701 97,00

Cuerpo empotrado incluido.

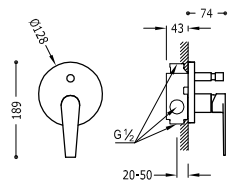

Grifo monomando empotrado de 2 vías para bañera y ducha

20518001 139,00

Cuerpo empotrado incluido. Inversor de 2 vías.

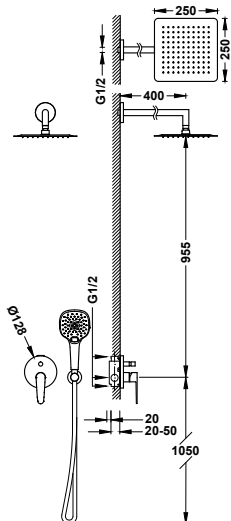

Kit de grifo monomando empotrado de 2 vías para ducha

20518006 418,00

- Cuerpo empotrado incluido.
- Inversor de 2 vías.
- Brazo a pared con rociador de ducha orientable y de acero inoxidable: 250x250 mm.
- Soporte para ducha de mano con toma de agua a pared.
- Ducha de mano anticalcárea: 120x120 mm. (3 tipos de chorro).
- Flexo satinado.



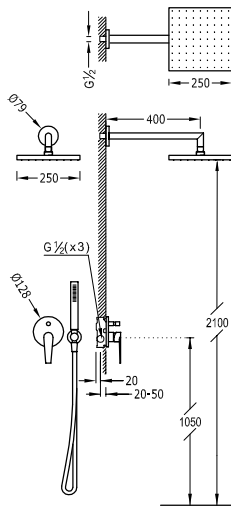

Kit de grifo monomando empotrado de 2 vías para ducha

20518002

412,00

- Cuerpo empotrado incluido.
- Inversor de 2 vías.
- Brazo a pared con rociador de ducha orientable y de acero inoxidable: 250x250 mm.
- Soporte para ducha de mano con toma de agua a pared.
- Ducha de mano anticalcárea.
- Flexo satinado.

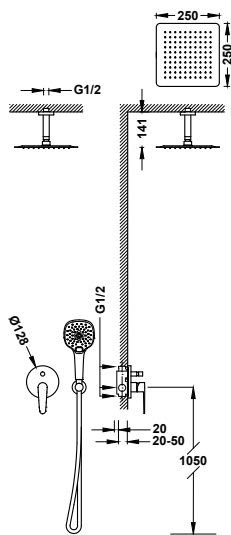

Kit de grifo monomando empotrado de 2 vías para ducha

20518007

391,00

- Cuerpo empotrado incluido.
- Inversor de 2 vías.
- Brazo a techo con rociador de ducha orientable y de acero inoxidable: 250x250 mm.
- Soporte para ducha de mano con toma de agua a pared.
- Ducha de mano anticalcárea: 120x120 mm. (3 tipos de chorro).
- Flexo satinado.



GRIFOS PARA BAÑERA

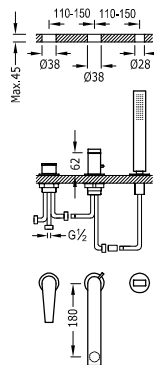

Grifo monomando para borde de bañera

20516103

310,00

- Inversor integrado en el caño de bañera.
- Ducha de mano anticalcárea.
- Caño de bañera de 180 mm. Caudal: 3 bar - 13 l/m.
- Kit depósito opcional no incluido ref.: 20024501.



Depósito para grifería de borde de bañera

20324501

415,00



Válvula de desagüe Click-clack para bañera con rebosadero y toma de drenaje

134445

100,00



Grifo monomando para borde de bañera

20516101 320,00

- Inversor integrado en el caño de bañera.
- Ducha de mano anticalcárea.
- Caño de bañera de 230 mm. Caudal: 3 bar - 13 l/m.
- Kit depósito opcional no incluido ref.: 20024501.



Depósito para grifería de borde de bañera

20324501 415,00

Válvula de desagüe Click-clack para bañera con rebosadero y toma de drenaje

134445 100,00

GRIFOS TERMOSTÁTICOS MURALES

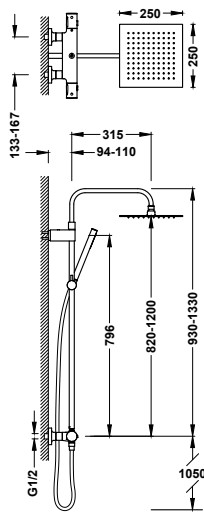

Conjunto de grifo termostático mural Over-wall de 2 vías para ducha

19038709 539,00

- Con inversor integrado en el regulador de caudal.
- Barra de ducha telescópica.
- Volante redondo.
- Rociador de ducha orientable de acero inoxidable: 250x250 mm.
- Soporte deslizante y orientable para ducha de mano.
- Ducha de mano anticalcárea de latón.
- Flexo satinado.

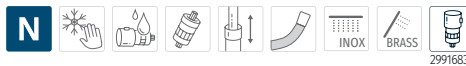

GRIFOS TERMOSTÁTICOS EMPOTRADOS

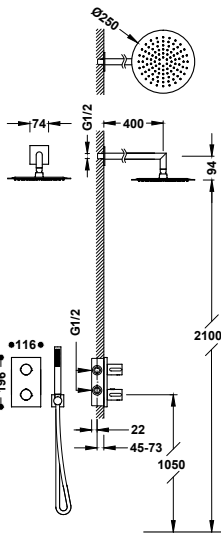

Kit de grifo termostático empotrado de 2 vías Therm-box para ducha

06225004 515,00

- Cuerpo empotrado incluido.
- Volante redondo con control de temperatura. Distribuidor cerámico de 2 vías.
- Brazo a pared con rociador de ducha orientable y de acero inoxidable: Ø 250 mm.
- Soporte para ducha de mano con toma de agua a pared.
- Ducha de mano anticalcárea de latón.
- Flexo satinado.





FLAT

El punto fuerte de Flat reside en su sencillez. Esbelta, cómoda y funcional, esta serie da como resultado un baño asequible a la vez que especial. Flat es la sencillez que destaca.

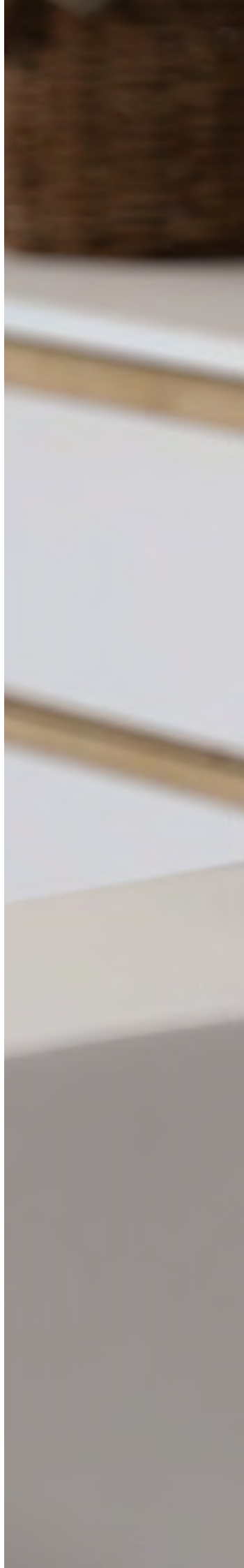





GRIFOS PARA LAVABO

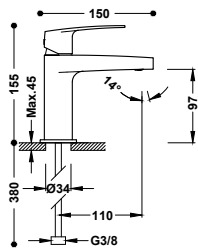

Grifo monomando para lavabo

22010301

85,00

Latiguillos de alimentación flexibles G3/8.

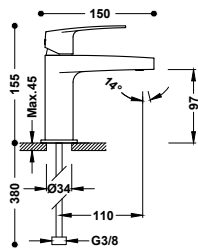

Grifo monomando ecoeficiente para lavabo

22010401

93,00

Latiguillos de alimentación flexibles G3/8.

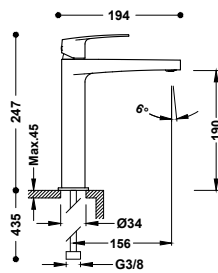

Grifo monomando alto ecoeficiente para lavabo

22020401

155,00

Latiguillos de alimentación flexibles G3/8.

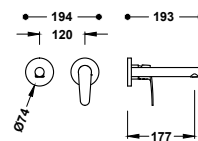

Pieza vista para cuerpo empotrado de lavabo

22030021

200,00

Solo parte vista. Incluye placa embellecedora, mando y caño de 177 mm. Cuerpo empotrado no incluido.



Cuerpo empotrado para grifo de lavabo

20830002

→405

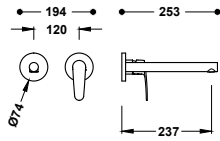

Pieza vista para cuerpo empotrado de lavabo

22030022

210,00

Solo parte vista. Incluye placa embellecedora, mando y caño de 237 mm. Cuerpo empotrado no incluido.



Cuerpo empotrado para grifo de lavabo

20830002

→405

GRIFOS PARA BIDÉ

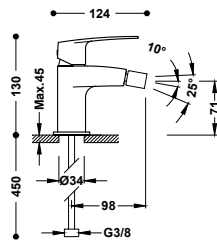

Grifo monomando para bidé

22012001

88,00

Latiguillos de alimentación flexibles G3/8.



GRIFOS MURALES

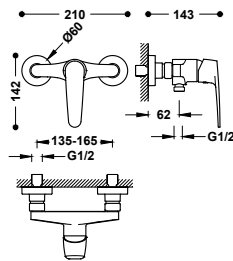

Grifo monomando mural para ducha

22016701

120,00

Ducha de mano anticalcárea. Soporte orientable para ducha de mano. Flexo metálico.

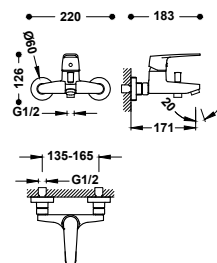

Grifo monomando mural para bañera y ducha

22017001

140,00

Ducha de mano anticalcárea. Soporte orientable para ducha de mano. Flexo metálico.



GRIFOS EMPOTRADOS

Pieza vista para caja empotrada de 1 vía Rapid-box

20427810

63,00

Sólo parte vista. Incluye placa embellecedora, mando, casquillo y tornillo de fijación oculto. Completar con la caja empotrada Rapid-box ref: 20827810.

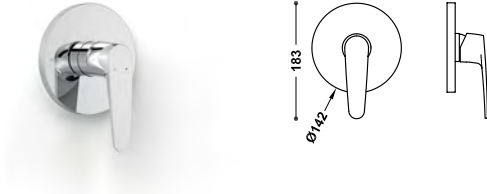

Caja empotrada de 1 vía Rapid-box con grifo monomando para ducha

20827810

[→405](#)

Pieza vista para caja empotrada de 2 vías Rapid-box

20428110

79,00

Sólo parte vista. Incluye placa embellecedora, mando, volante distribuidor y tornillo de fijación oculto. Completar con la caja empotrada Rapid-box ref: 20828110.

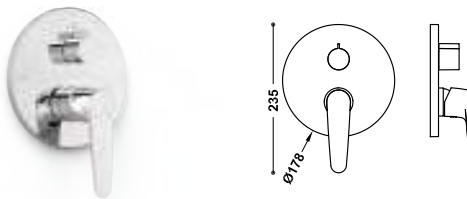

Caja empotrada de 2 vías Rapid-box con grifo monomando para ducha y bañera

20828110

[→405](#)

Kit de grifo monomando empotrado de 2 vías Rapid-box para ducha

20428004

364,00

- Cuerpo empotrado incluido.
- Distribuidor cerámico de 2 vías.
- Brazo a pared con rociador de ducha orientable y de acero inoxidable: Ø 250 mm.
- Soporte para ducha de mano con toma de agua a pared.
- Ducha de mano anticalcárea: Ø 110 mm.
- Flexo satinado.

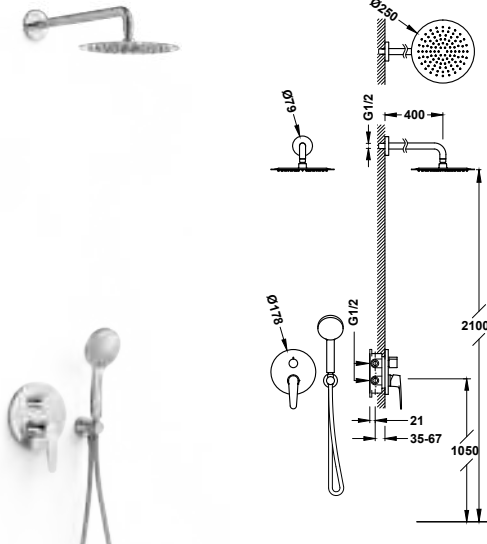

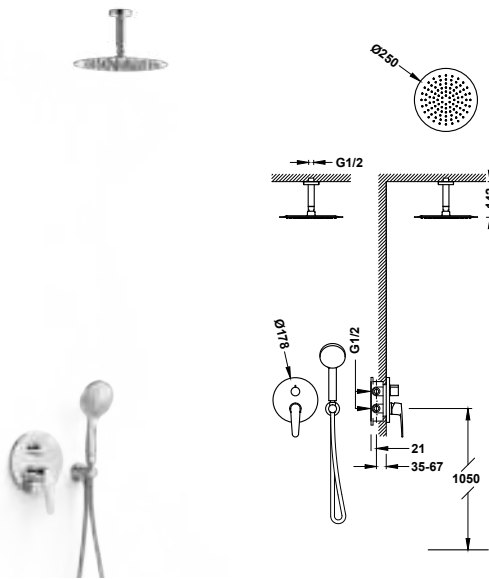

**Kit de grifo monomando empotrado de 2 vías
Rapid-box para ducha**

20428003

337,00

- Cuerpo empotrado incluido.
- Distribuidor cerámico de 2 vías.
- Brazo a techo con rociador de ducha orientable y de acero inoxidable: Ø 250 mm.
- Soporte para ducha de mano con toma de agua a pared.
- Ducha de mano anticalcárea: Ø 110 mm.
- Flexo satinado.

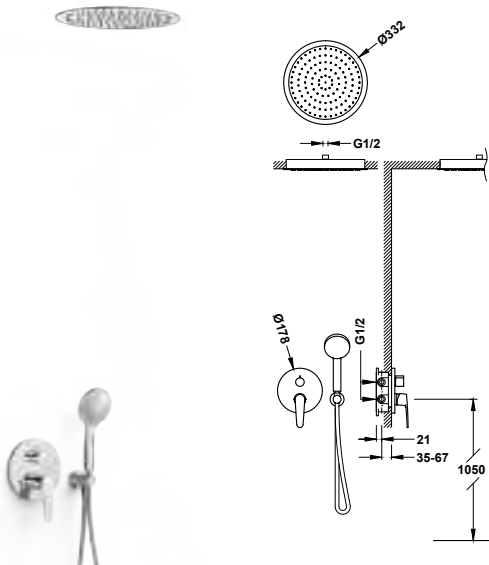

**Kit de grifo monomando empotrado de 2 vías
Rapid-box para ducha**

20428005

603,00

- Cuerpo empotrado incluido.
- Distribuidor cerámico de 2 vías.
- Rociador empotrado a techo de latón: Ø 332 mm.
- Soporte para ducha de mano con toma de agua a pared.
- Ducha de mano anticalcárea: Ø 110 mm.
- Flexo satinado.

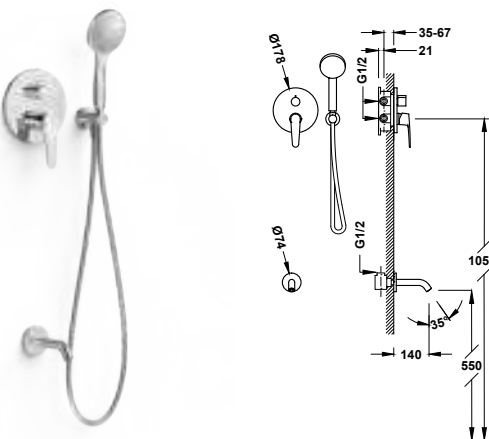

**Kit de grifo monomando empotrado de 2 vías
Rapid-box para bañera y ducha**

20428006

310,00

- Cuerpo empotrado incluido.
- Distribuidor cerámico de 2 vías.
- Caño fijo de bañera a pared.
- Soporte para ducha de mano con toma de agua a pared.
- Ducha de mano anticalcárea: Ø 110 mm.
- Flexo satinado.



Grifo monomando empotrado de 1 vía para ducha
Cuerpo empotrado incluido.

■ 20417701

95,00

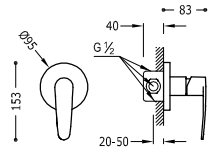

9130190

Grifo monomando empotrado de 2 vías para bañera y ducha

■ 20418001

135,00

Cuerpo empotrado incluido. Inversor de 2 vías.

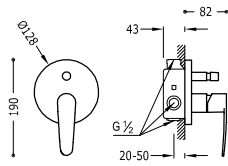

9130190

Kit de grifo monomando empotrado de 2 vías para ducha

■ 20418002

375,00

- Cuerpo empotrado incluido.
- Inversor de 2 vías.
- Brazo a pared con rociador de ducha orientable y de acero inoxidable: Ø 250 mm.
- Soporte para ducha de mano con toma de agua a pared.
- Ducha de mano anticalcárea: Ø 100 mm.
- Flexo satinado.

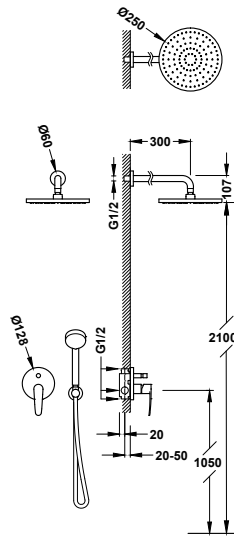

9130190

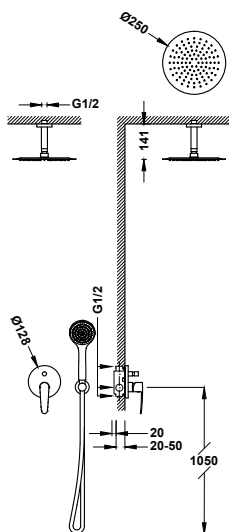

Kit de grifo monomando empotrado de 2 vías para ducha

■ 20418005 354,00

- Cuerpo empotrado incluido.
- Inversor de 2 vías.
- Brazo a techo con rociador de ducha orientable y de acero inoxidable: Ø 250 mm.
- Soporte para ducha de mano con toma de agua a pared.
- Ducha de mano anticalcárea: Ø 100 mm.
- Flexo satinado.



GRIFOS TERMOSTÁTICOS MURALES

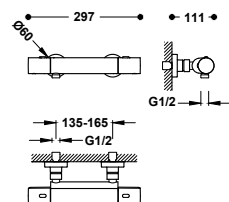

Grifo termostático mural Over-wall para ducha

■ 19016419 163,00
 ■ 19016419NM 346,00

Ducha de mano anticalcárea: Ø 100 mm. Soporte orientable para ducha de mano. Flexo metálico. Volante redondo de ABS.



Grifo termostático sin complementos

■ 19016401 178,00
 ■ 19016401NM 276,00

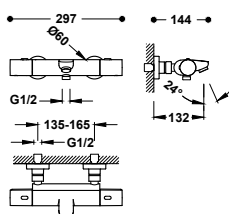

Grifo termostático mural Over-wall para bañera y ducha

■ 19017419 288,00
 ■ 19017419NM 446,00

Ducha de mano anticalcárea: Ø 100 mm. Soporte orientable para ducha de mano. Flexo metálico. Volante redondo de ABS.



Grifo termostático sin complementos

■ 19017401 243,00
 ■ 19017401NM 377,00



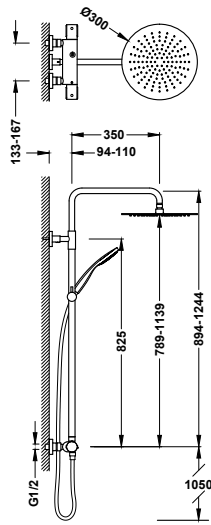

Conjunto de grifo termostático mural Over-wall de 2 vías para ducha

■ 19038701	480,00
■ 19038701NM	744,00

- Con inversor integrado en el regulador de caudal.
- Volante redondo de ABS.
- Barra de ducha telescópica.
- Rociador de ducha orientable de acero inoxidable: Ø 300 mm.
- Soporte deslizante y orientable para ducha de mano.
- Ducha de mano anticalcárea.
- Flexo metálico.



299168310X

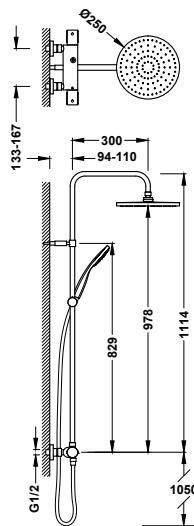

Conjunto de grifo termostático mural Over-wall de 2 vías para ducha

■ 19039301	412,00
■ 19039301NM	639,00

- Con inversor integrado en el regulador de caudal.
- Volante redondo de ABS.
- Rociador de ducha orientable: Ø 250 mm.
- Soporte deslizante y orientable para ducha de mano.
- Ducha de mano anticalcárea: Ø 100 mm.
- Flexo metálico.



299168310X

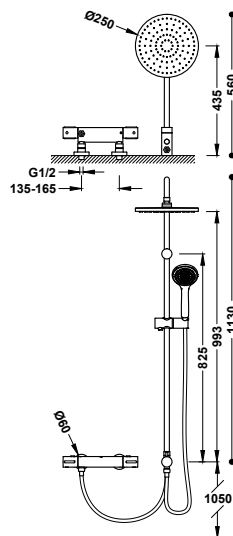

Conjunto de grifo termostático mural Over-wall de 2 vías para ducha

■ 19038501	475,00
------------	--------

- Con inversor integrado en la barra de ducha.
- Volante redondo de ABS.
- Rociador de ducha orientable: Ø 250 mm.
- Soporte deslizante y orientable para ducha de mano.
- Ducha de mano anticalcárea: Ø 100 mm.
- Flexo metálico.

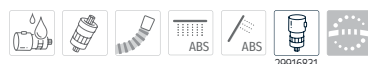

29916831

GRIFOS TERMOSTÁTICOS EMPOTRADOS

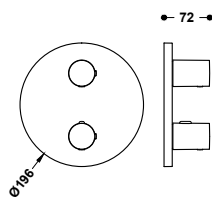

Pieza vista para caja empotrada de 2 vías Therm-box

20425001

90,00

Sólo parte vista. Volante redondo de ABS. Incluye placa embellecedora, mando y volante distribuidor. Completar con la caja empotrada Therm-box ref: 20785001.



Caja empotrada de 2 vías Therm-box con grifo termostático para ducha y bañera

20785001

→405

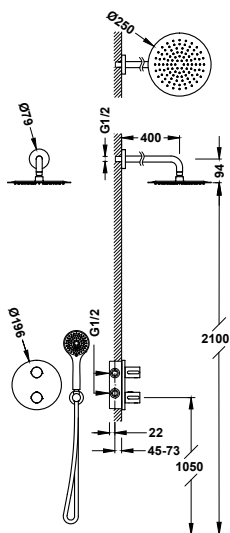

Kit de grifo termostático empotrado de 2 vías Therm-box para ducha

20425004

526,00

- Cuerpo empotrado incluido.
- Volante redondo de ABS con control de temperatura.
- Distribuidor cerámico de 2 vías.
- Brazo a pared con rociador de ducha orientable y de acero inoxidable: Ø 250 mm.
- Soporte para ducha de mano con toma de agua a pared.
- Ducha de mano anticalcárea: Ø 100 mm. (3 tipos de chorro).
- Flexo satinado.

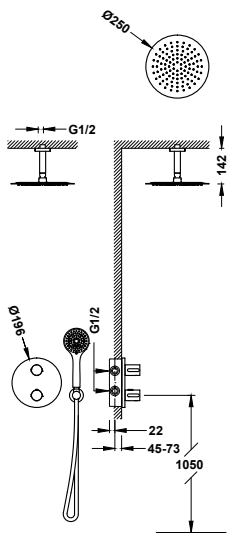

Kit de grifo termostático empotrado de 2 vías Therm-box para ducha

20425003

496,00

- Cuerpo empotrado incluido.
- Volante redondo de ABS con control de temperatura.
- Distribuidor cerámico de 2 vías.
- Brazo a techo con rociador de ducha orientable y de acero inoxidable: Ø 250 mm.
- Soporte para ducha de mano con toma de agua a pared.
- Ducha de mano anticalcárea: Ø 100 mm. (3 tipos de chorro).
- Flexo satinado.



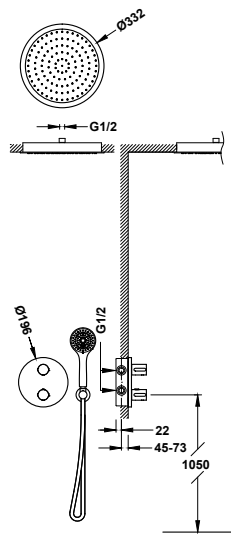

**Kit de grifo termostático empotrado de 2 vías
Therm-box para ducha**

20425005

805,00

- Cuerpo empotrado incluido.
- Volante redondo de ABS con control de temperatura.
- Distribuidor cerámico de 2 vías.
- Rociador empotrado a techo de latón: Ø 332 mm.
- Soporte para ducha de mano con toma de agua a pared.
- Ducha de mano anticalcárea: Ø 100 mm. (3 tipos de chorro).
- Flexo satinado.

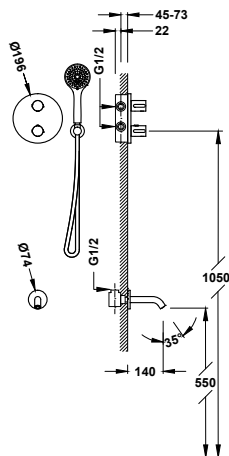
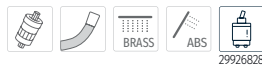

**Kit de grifo termostático empotrado de 2 vías
Therm-box para bañera y ducha**

20425006

510,00

- Cuerpo empotrado incluido.
- Volante redondo de ABS con control de temperatura.
- Distribuidor cerámico de 2 vías.
- Caño fijo de bañera a pared.
- Soporte para ducha de mano con toma de agua a pared.
- Ducha de mano anticalcárea: Ø 100 mm. (3 tipos de chorro).
- Flexo satinado.





CANIGÓ PLUS

El equilibrio entre el diseño y una buena experiencia en el baño no está reñido con la sostenibilidad. Canigó Plus incorpora en su grifería unas características que favorecen el ahorro de agua y energía ayudando a convertir cualquier baño en un espacio sostenible.







GRIFOS PARA LAVABO

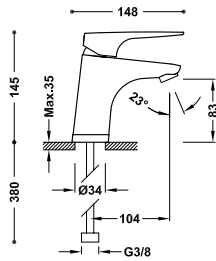

Grifo monomando para lavabo

Latiguillos de alimentación flexibles G3/8.

21810303

82,00

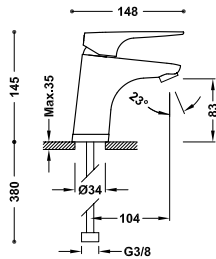

Grifo monomando para lavabo con Tres-duo

Latiguillos de alimentación flexibles G3/8.

21810301

84,00

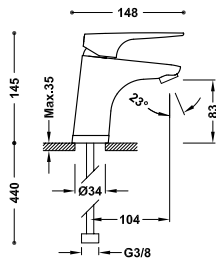

Grifo monomando ecoeficiente para lavabo

Latiguillos de alimentación flexibles G3/8.

21810401

91,00

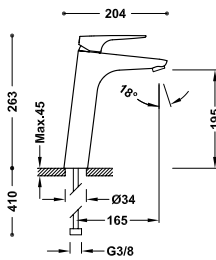

Grifo monomando alto para lavabo

Latiguillos de alimentación flexibles G3/8.

21820303

145,00

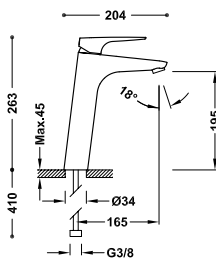

Grifo monomando alto para lavabo con Tres-duo

Latiguillos de alimentación flexibles G3/8.

21820301



147,00

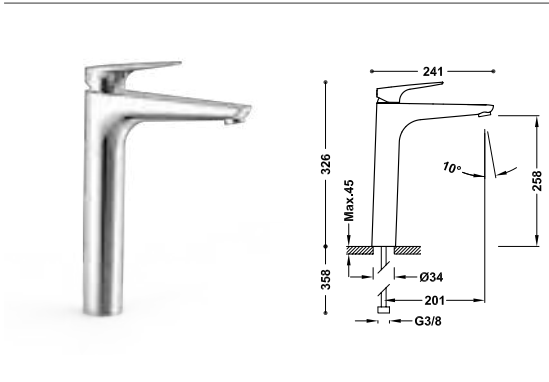

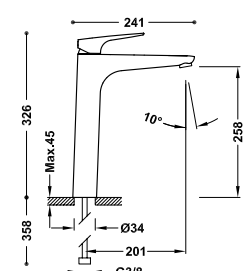

Grifo monomando XXL para lavabo 21880301 180,00

Latiguillos de alimentación flexibles G3/8.

Grifo monomando con maneta lateral para lavabo 21830802 128,00

Latiguillos de alimentación flexibles G3/8.





Grifo monomando alto con maneta lateral para lavabo 21830801 134,00

Latiguillos de alimentación flexibles G3/8.



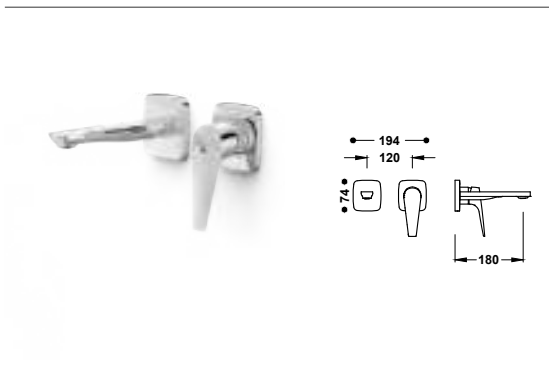

Pieza vista para cuerpo empotrado de lavabo 21830023 108,00

Solo parte vista. Incluye placa embellecedora, mando y caño de 180 mm. Cuerpo empotrado no incluido.

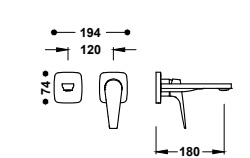

N



Cuerpo empotrado para grifo de lavabo 20830002

[→405](#)

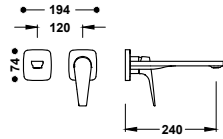

Pieza vista para cuerpo empotrado de lavabo

21830024

118,00

Solo parte vista. Incluye placa embellecedora, mando y caño de 240 mm. Cuerpo empotrado no incluido.



Cuerpo empotrado para grifo de lavabo

20830002

[→ 405](#)

GRIFOS PARA BIDÉ

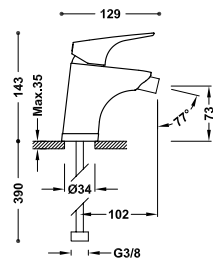

Grifo monomando para bidé

21812001

85,00

Latiguillos de alimentación flexibles G3/8.



GRIFOS MURALES

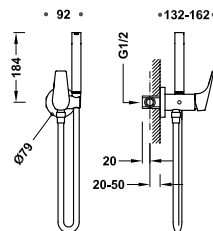

Grifo monomando empotrado con ducha para inodoro

21712301

175,00

Con agua fría y caliente. Ducha de mano con racor limitador a 5 l/min. y sistema antigoteo. Soporte fijo para la ducha de mano instalable a derecha o izquierda. Flexo satinado.

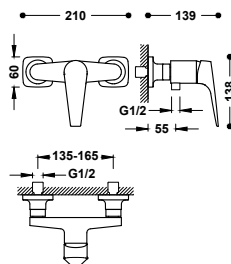

Grifo monomando mural para ducha

21826701

98,00

Sin complementos.



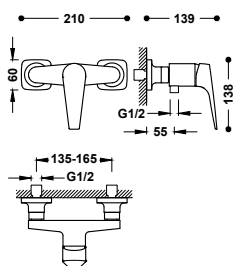

Grifo monomando mural para ducha

■ 21816701

118,00

Ducha de mano anticalcárea 120x120 mm. (3 tipos de chorro). Soporte orientable para ducha de mano. Flexo metálico.

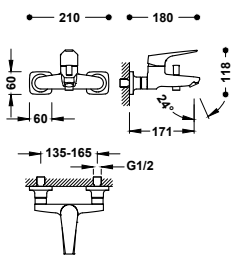

Grifo monomando mural para bañera y ducha

■ 21827001

118,00

Sin complementos.

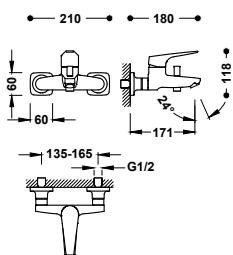

Grifo monomando mural para bañera y ducha

■ 21817001

139,00

Ducha de mano anticalcárea 120x120 mm. (3 tipos de chorro). Soporte orientable para ducha de mano. Flexo metálico.

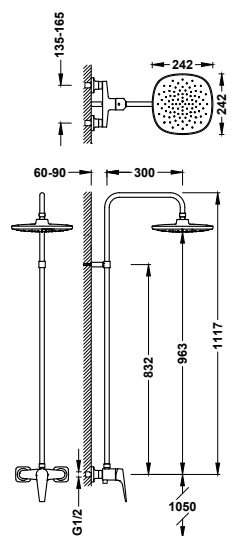

Conjunto de grifo monomando mural de 1 vía para ducha

■ 21899501

255,00

· Rociador de ducha orientable: 242x242 mm.



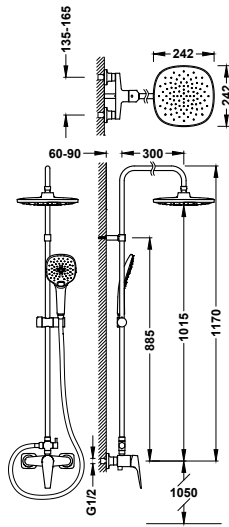

Conjunto de grifo monomando mural de 2 vías para ducha

21819101

300,00

- Con inversor integrado en la barra de ducha.
- Rociador de ducha orientable: 242x242 mm.
- Soporte deslizante y orientable para ducha de mano.
- Ducha de mano anticalcárea 120x120 mm. (3 tipos de chorro).
- Flexo metálico.

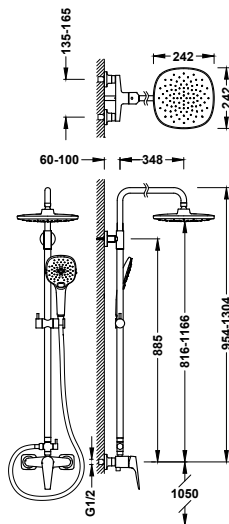

Conjunto de grifo monomando mural de 2 vías para ducha

21831221

417,00

- Con inversor integrado en la barra de ducha.
- Barra de ducha telescópica.
- Rociador de ducha orientable: 242x242 mm.
- Soporte deslizante y orientable para ducha de mano.
- Ducha de mano anticalcárea 120x120 mm. (3 tipos de chorro).
- Flexo metálico.

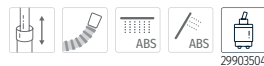

GRIFOS EMPOTRADOS

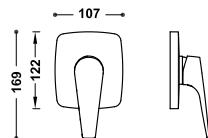

Pieza vista para caja empotrada de 1 vía Rapid-box

21827810

63,00

Sólo parte vista. Incluye placa embellecedora, mando, casquillo y tornillo de fijación oculto. Completar con la caja empotrada Rapid-box ref.: 20827810.



Caja empotrada de 1 vía Rapid-box con grifo monomando para ducha

20827810

→ 405

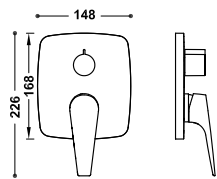

Pieza vista para caja empotrada de 2 vías Rapid-box

21828110

79,00

Sólo parte vista. Incluye placa embellecedora, mando, volante distribuidor y tornillo de fijación oculto. Completar con la caja empotrada Rapid-box ref: 20828110.



Caja empotrada de 2 vías Rapid-box con grifo monomando para ducha y bañera

20828110

[→405](#)

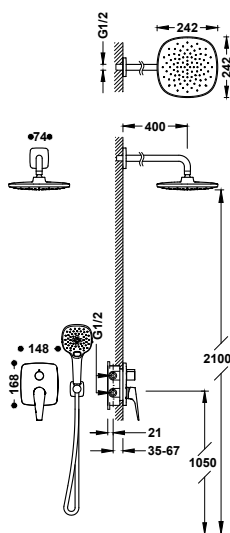

Kit de grifo monomando empotrado de 2 vías Rapid-box para ducha

21828004

370,00

- Cuerpo empotrado incluido.
- Distribuidor cerámico de 2 vías.
- Brazo a pared con rociador de ducha orientable: 242x242 mm.
- Soporte para ducha de mano con toma de agua a pared.
- Ducha de mano anticalcárea 120x120 mm. (3 tipos de chorro).
- Flexo metálico.

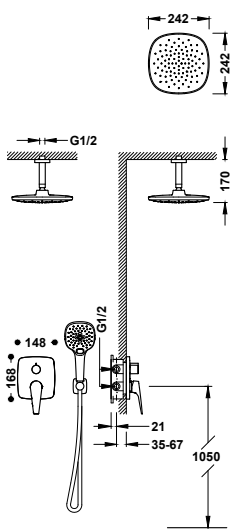

Kit de grifo monomando empotrado de 2 vías Rapid-box para ducha

21828003

343,00

- Cuerpo empotrado incluido.
- Distribuidor cerámico de 2 vías.
- Brazo a techo con rociador de ducha orientable: 242x242 mm.
- Soporte para ducha de mano con toma de agua a pared.
- Ducha de mano anticalcárea 120x120 mm. (3 tipos de chorro).
- Flexo metálico.



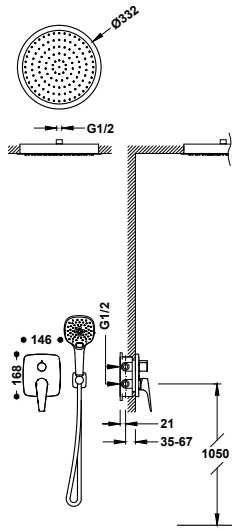

Kit de grifo monomando empotrado de 2 vías Rapid-box para ducha

21828005

592,00

- Cuerpo empotrado incluido.
- Distribuidor cerámico de 2 vías.
- Rociador empotrado a techo de latón: Ø 332 mm.
- Soporte para ducha de mano con toma de agua a pared.
- Ducha de mano anticalcárea 120x120 mm. (3 tipos de chorro).
- Flexo metálico.



Kit de grifo monomando empotrado de 2 vías Rapid-box para bañera y ducha

21828006

340,00

- Cuerpo empotrado incluido.
- Distribuidor cerámico de 2 vías.
- Caño fijo de bañera a pared.
- Soporte para ducha de mano con toma de agua a pared.
- Ducha de mano anticalcárea 120x120 mm. (3 tipos de chorro).
- Flexo metálico.

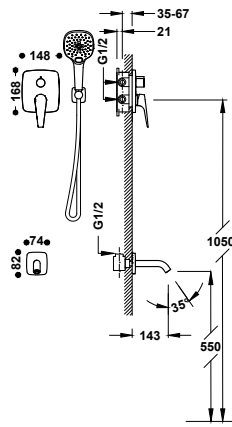

GRIFOS TERMOSTÁTICOS MURALES

Grifo termostático mural para ducha

21716409

227,00

- Ducha de mano anticalcárea 120x120 mm. (3 tipos de chorro).
- Soporte orientable para ducha de mano. Flexo metálico.
- Volante redondo.

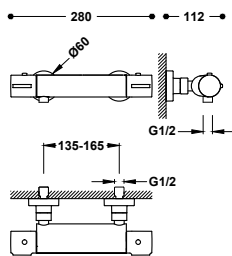

Grifo termostático mural para bañera y ducha

21717419

302,00

- Inversor integrado en el regulador de caudal. Ducha de mano anticalcárea 120x120 mm. (3 tipos de chorro). Soporte orientable para ducha de mano. Flexo metálico.

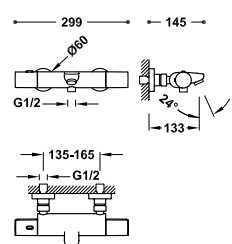

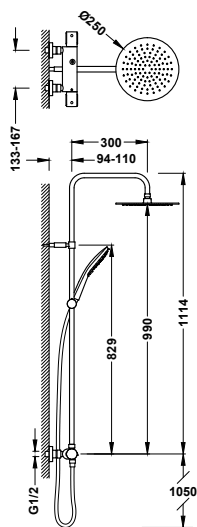

Conjunto de grifo termostático mural Over-wall de 2 vías para ducha

19039316

464,00

- Con inversor integrado en el regulador de caudal.
- Volante redondo de ABS.
- Rociador de ducha orientable de acero inoxidable: Ø250 mm.
- Soporte deslizante y orientable para ducha de mano.
- Ducha de mano anticalcárea: 120x120 mm. (3 tipos de chorro).
- Flexo metálico.



GRIFOS TERMOSTÁTICOS EMPOTRADOS

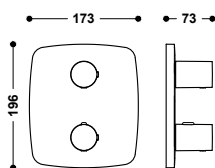

Pieza vista para caja empotrada de 2 vías Therm-box

21725001

90,00

Sólo parte vista. Volante redondo de ABS. Incluye placa embellecedora, mando y volante distribuidor. Completar con la caja empotrada Therm-box ref.: 20785001.



Caja empotrada de 2 vías Therm-box con grifo termostático para ducha y bañera

20785001

[→ 405](#)

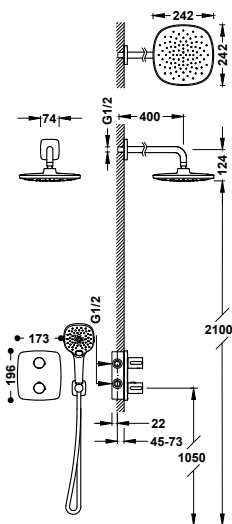

Kit de grifo termostático empotrado de 2 vías Therm-box para ducha

21725004

512,00

- Cuerpo empotrado incluido.
- Volante redondo de ABS con control de temperatura.
- Distribuidor cerámico de 2 vías.
- Brazo a pared con rociador de ducha orientable: 242x242 mm.
- Soporte para ducha de mano con toma de agua a pared.
- Ducha de mano anticalcárea 120x120 mm. (3 tipos de chorro).
- Flexo metálico.



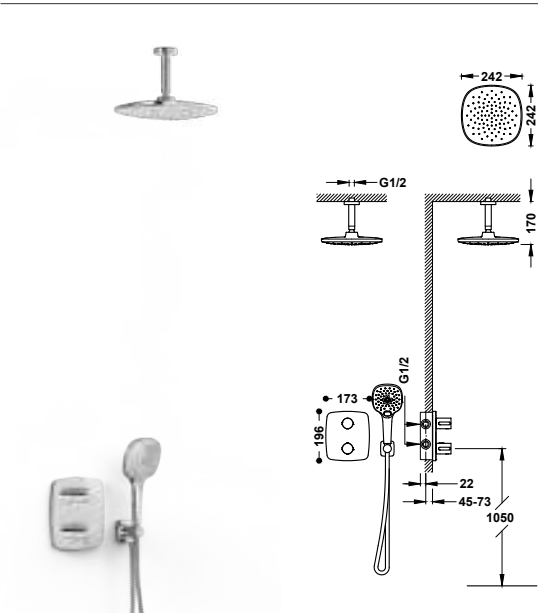

**Kit de grifo termostático empotrado de 2 vías
Therm-box para ducha**

21725003

482,00

- Cuerpo empotrado incluido.
- Volante redondo de ABS con control de temperatura.
- Distribuidor cerámico de 2 vías.
- Brazo a techo con rociador de ducha orientable: 242x242 mm.
- Soporte para ducha de mano con toma de agua a pared.
- Ducha de mano anticalcárea 120x120 mm. (3 tipos de chorro).
- Flexo metálico.



29926828

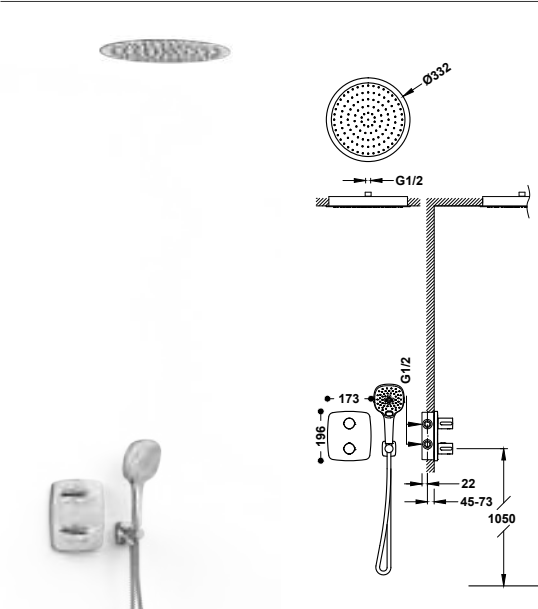

**Kit de grifo termostático empotrado de 2 vías
Therm-box para ducha**

21725005

790,00

- Cuerpo empotrado incluido.
- Volante redondo de ABS con control de temperatura.
- Distribuidor cerámico de 2 vías.
- Rociador empotrado a techo de latón: Ø 332 mm.
- Soporte para ducha de mano con toma de agua a pared.
- Ducha de mano anticalcárea 120x120 mm. (3 tipos de chorro).
- Flexo metálico.

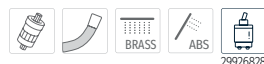

29926828

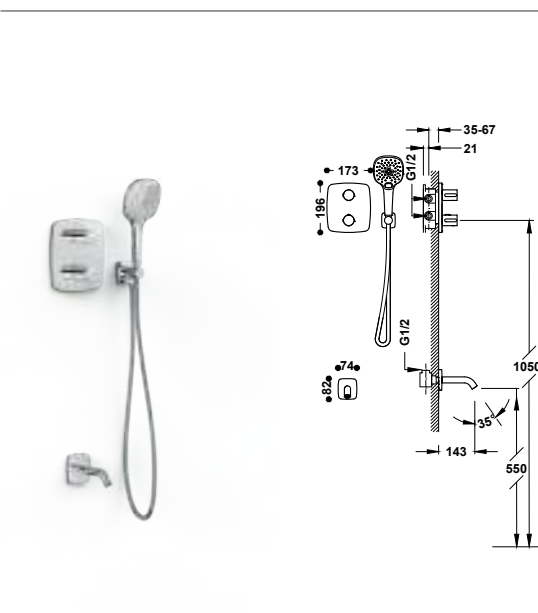

**Kit de grifo termostático empotrado de 2 vías
Therm-box para bañera y ducha**

21725006

495,00

- Cuerpo empotrado incluido.
- Volante redondo de ABS con control de temperatura.
- Distribuidor cerámico de 2 vías.
- Caño fijo de bañera a pared.
- Soporte para ducha de mano con toma de agua a pared.
- Ducha de mano anticalcárea 120x120 mm. (3 tipos de chorro).
- Flexo metálico.



29926828



CANIGÓ

Tres ha otorgado a la serie Canigó unas características que fomentan el ahorro de agua y de energía. La trayectoria inclinada de la maneta y la robustez de los cuerpos se integra con los ángulos redondeados de sus contornos, dotando de personalidad y diferenciación a toda la serie.







GRIFOS PARA LAVABO

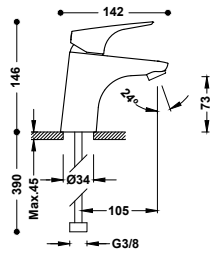

Grifo monomando para lavabo

■ 21710303

77,00

Latiguillos de alimentación flexibles G3/8.

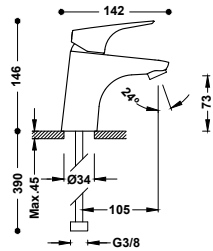

Grifo monomando para lavabo con Tres-duo

■ 21710301

79,00

Latiguillos de alimentación flexibles G3/8.

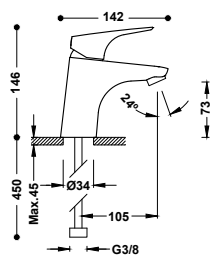

Grifo monomando ecoeficiente para lavabo

■ 21710401

85,00

Latiguillos de alimentación flexibles G3/8.

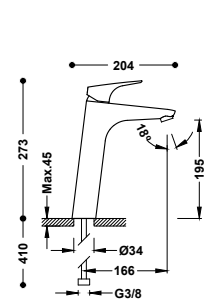

Grifo monomando alto para lavabo con Tres-duo

■ 21720301

144,00

Latiguillos de alimentación flexibles G3/8.

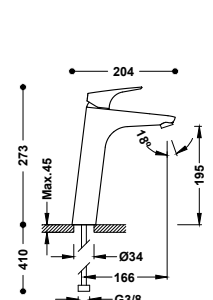

Grifo monomando alto para lavabo

■ 21720303

142,00

Latiguillos de alimentación flexibles G3/8.



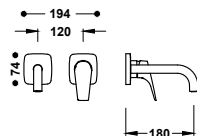

Pieza vista para cuerpo empotrado de lavabo

21730021

98,00

Solo parte vista. Incluye placa embellecedora, mando y caño de 180 mm. Cuerpo empotrado no incluido.



Cuerpo empotrado para grifo de lavabo

20830002

→405

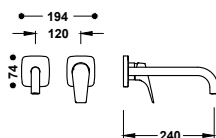

Pieza vista para cuerpo empotrado de lavabo

21730022

108,00

Solo parte vista. Incluye placa embellecedora, mando y caño de 240 mm. Cuerpo empotrado no incluido.



Cuerpo empotrado para grifo de lavabo

20830002

→405

GRIFOS PARA BIDÉ

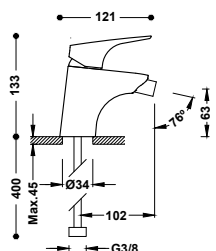

Grifo monomando para bidé

21712001

80,00

Latiguillos de alimentación flexibles G3/8.



29903504

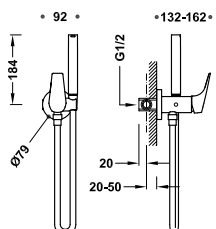

Grifo monomando empotrado con ducha para inodoro

21712301

175,00

Con agua fría y caliente. Ducha de mano con rcon limitador a 5 l/min. y sistema antigoteo. Soporte fijo para la ducha de mano instalable a derecha o izquierda. Flexo satinado.



9134591

GRIFOS MURALES

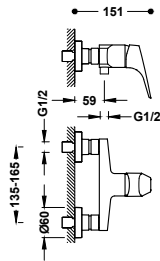

Grifo monomando mural para ducha

■ 21726701

82,00

Sin complementos.

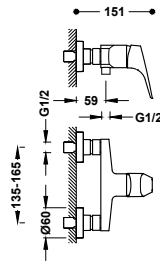

Grifo monomando mural para ducha

■ 21716701

103,00

Ducha de mano anticalcárea 120x120 mm. (3 tipos de chorro).
Soporte orientable para ducha de mano. Flexo metálico.

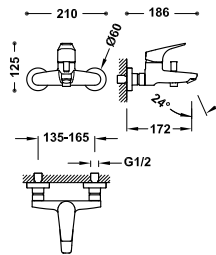

Grifo monomando mural para bañera y ducha

■ 21727001

103,00

Sin complementos.

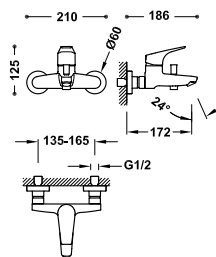

Grifo monomando mural para bañera y ducha

■ 21717001

123,00

Ducha de mano anticalcárea 120x120 mm. (3 tipos de chorro).
Soporte orientable para ducha de mano. Flexo metálico.



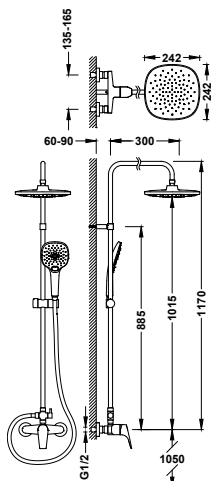

Conjunto de grifo monomando mural de 2 vías para ducha

21719101

293,00

- Con inversor integrado en la barra de ducha.
- Rociador de ducha orientable: 242x242 mm.
- Soporte deslizante y orientable para ducha de mano.
- Ducha de mano anticalcárea 120x120 mm. (3 tipos de chorro).
- Flexo metálico.

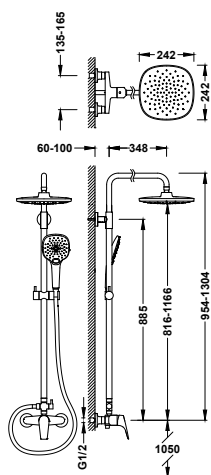

Conjunto de grifo monomando mural de 2 vías para ducha

21731221

405,00

- Con inversor integrado en la barra de ducha.
- Barra de ducha telescópica.
- Rociador de ducha orientable: 242x242 mm.
- Soporte deslizante y orientable para ducha de mano.
- Ducha de mano anticalcárea 120x120 mm. (3 tipos de chorro).
- Flexo metálico.



GRIFOS EMPOTRADOS

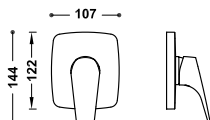

Pieza vista para caja empotrada de 1 vía Rapid-box

21727810

63,00

Sólo parte vista. Incluye placa embellecedora, mando, casquillo y tornillo de fijación oculto. Completar con la caja empotrada Rapid-box ref.: 20827810.



Caja empotrada de 1 vía Rapid-box con grifo monomando para ducha

20827810

[→405](#)

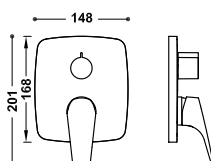

Pieza vista para caja empotrada de 2 vías Rapid-box

21728110

79,00

Sólo parte vista. Incluye placa embellecedora, mando, volante distribuidor y tornillo de fijación oculto. Completar con la caja empotrada Rapid-box ref.: 20828110.



Caja empotrada de 2 vías Rapid-box con grifo monomando para ducha y bañera

20828110

[→405](#)

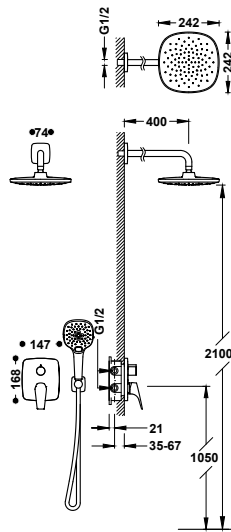

**Kit de grifo monomando empotrado de 2 vías
Rapid-box para ducha**

■ 21728004

368,00

- Cuerpo empotrado incluido.
- Distribuidor cerámico de 2 vías.
- Brazo a pared con rociador de ducha orientable: 242x242 mm.
- Soporte para ducha de mano con toma de agua a pared.
- Ducha de mano anticalcárea 120x120 mm. (3 tipos de chorro).
- Flexo metálico.

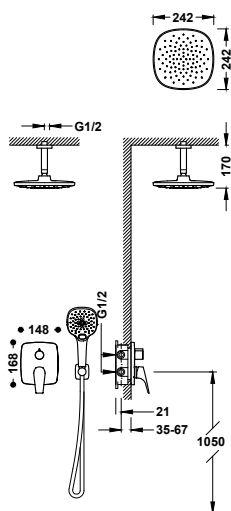

**Kit de grifo monomando empotrado de 2 vías
Rapid-box para ducha**

■ 21728003

341,00

- Cuerpo empotrado incluido.
- Distribuidor cerámico de 2 vías.
- Brazo a techo con rociador de ducha orientable: 242x242 mm.
- Soporte para ducha de mano con toma de agua a pared.
- Ducha de mano anticalcárea 120x120 mm. (3 tipos de chorro).
- Flexo metálico.

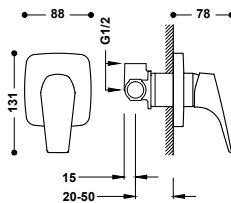
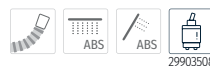

Grifo monomando empotrado de 1 vía para ducha

■ 21717701

95,00

Cuerpo empotrado incluido.

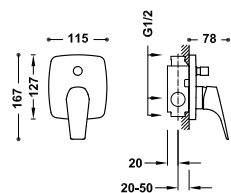

Grifo monomando empotrado de 2 vías para bañera y ducha

■ 21718001

136,00

Cuerpo empotrado incluido. Inversor de 2 vías.



GRIFOS TERMOSTÁTICOS MURALES

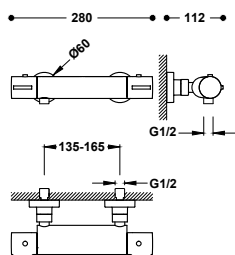

Grifo termostático mural para ducha

21716401

182,00

Sin complementos. Volante redondo.

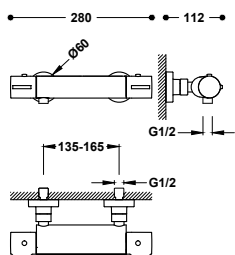

Grifo termostático mural para ducha

21716409

227,00

Ducha de mano anticalcárea 120x120 mm. (3 tipos de chorro). Soporte orientable para ducha de mano. Flexo metálico. Volante redondo.

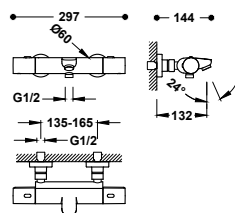

Grifo termostático mural Over-wall para bañera y ducha

19017401

243,00

Sin complementos. Inversor integrado en el regulador de caudal. Volante redondo de ABS.

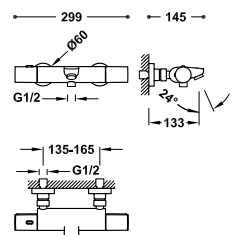

Grifo termostático mural para bañera y ducha

21717419

302,00

Inversor integrado en el regulador de caudal. Ducha de mano anticalcárea 120x120 mm. (3 tipos de chorro). Soporte orientable para ducha de mano. Flexo metálico.

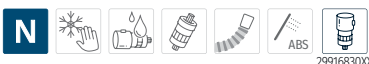

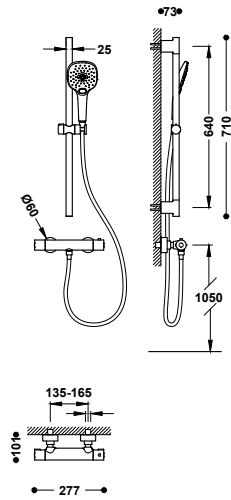

Kit de grifo termostático mural para ducha

21738502

259,00

- Barra de ducha: long. 640 mm.
- Soporte deslizante y orientable para ducha de mano.
- Ducha de mano anticalcárea 120x120 mm. (3 tipos de chorro).
- Flexo metálico.

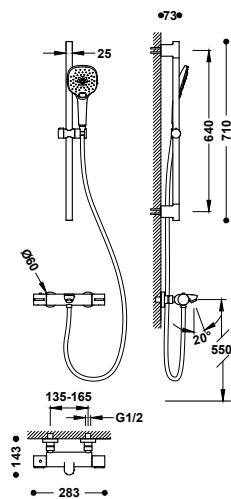

Kit de grifo termostático mural para bañera y ducha

21738501

312,00

- Barra de ducha: long. 640 mm.
- Soporte deslizante y orientable para ducha de mano.
- Ducha de mano anticalcárea 120x120 mm. (3 tipos de chorro).
- Flexo metálico.



29916804

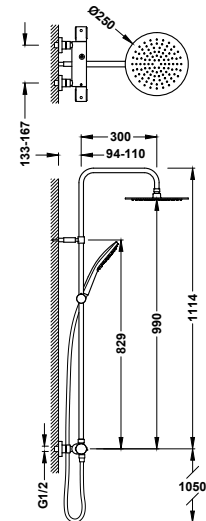

Conjunto de grifo termostático mural Over-wall de 2 vías para ducha

19039316

464,00

- Con inversor integrado en el regulador de caudal.
- Volante redondo de ABS.
- Rociador de ducha orientable de acero inoxidable: Ø250 mm.
- Soporte deslizante y orientable para ducha de mano.
- Ducha de mano anticalcárea: 120x120 mm. (3 tipos de chorro).
- Flexo metálico.



29916831

GRIFOS TERMOSTÁTICOS EMPOTRADOS

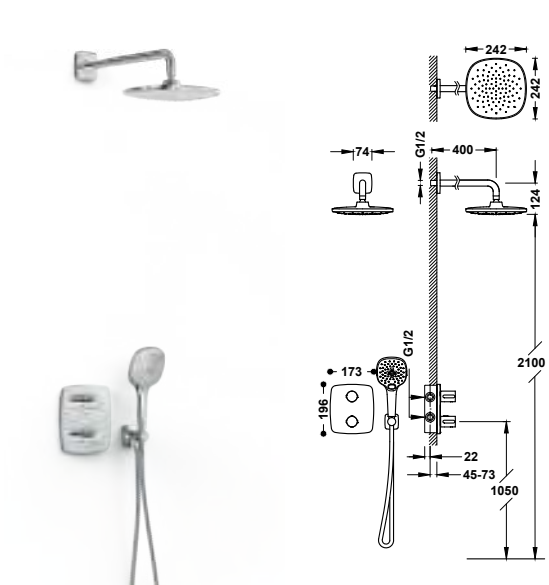

**Kit de grifo termostático empotrado de 2 vías
Therm-box para ducha**

21725004

512,00

- Cuerpo empotrado incluido.
- Volante redondo de ABS con control de temperatura.
- Distribuidor cerámico de 2 vías.
- Brazo a pared con rociador de ducha orientable: 242x242 mm.
- Soporte para ducha de mano con toma de agua a pared.
- Ducha de mano anticalcárea 120x120 mm. (3 tipos de chorro).
- Flexo metálico.

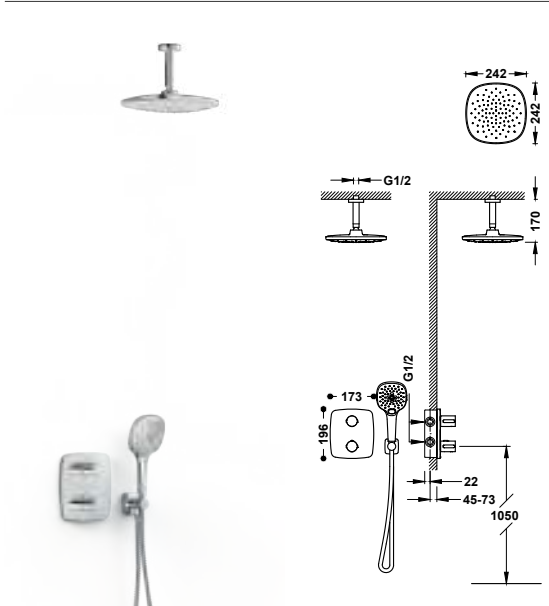

**Kit de grifo termostático empotrado de 2 vías
Therm-box para ducha**

21725003

482,00

- Cuerpo empotrado incluido.
- Volante redondo de ABS con control de temperatura.
- Distribuidor cerámico de 2 vías.
- Brazo a techo con rociador de ducha orientable: 242x242 mm.
- Soporte para ducha de mano con toma de agua a pared.
- Ducha de mano anticalcárea 120x120 mm. (3 tipos de chorro).
- Flexo metálico.

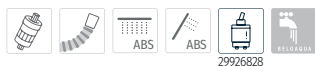





BASE PLUS

La serie Base Plus se caracteriza por sus líneas simples y adaptables a cualquier ambiente. Su aspecto minimalista, así como un mando ergonómico y un cuerpo con líneas sinuosas, agradables y claras, permite equipar el baño con los elementos esenciales.

CR

NM

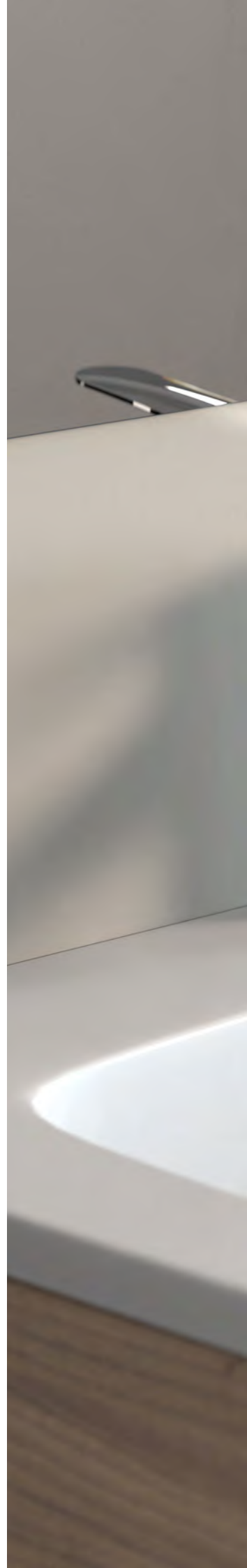



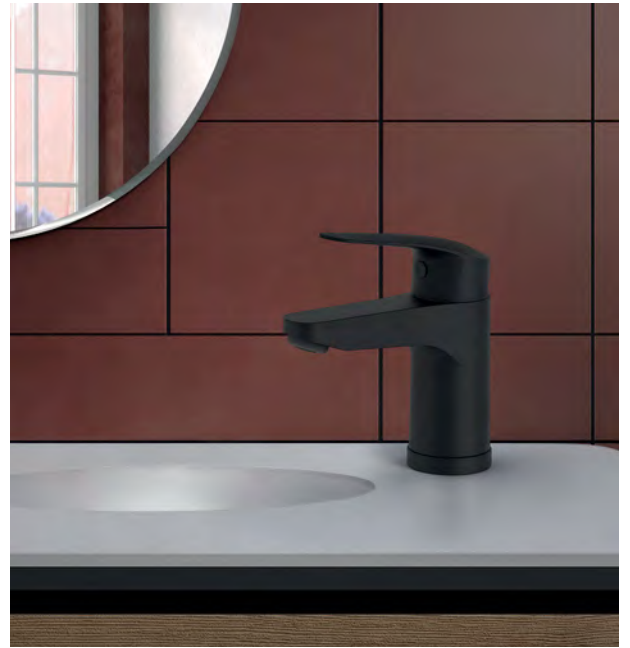

GRIFOS PARA LAVABO

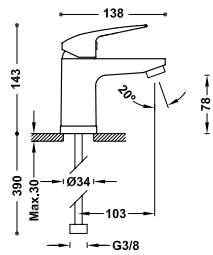

Grifo monomando para lavabo

Latiguillos de alimentación flexibles G3/8.

21610303

60,00

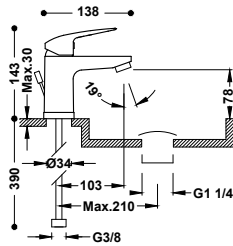

Grifo monomando para lavabo con desagüe automático

Latiguillos de alimentación flexibles G3/8.

21610303DA

74,00

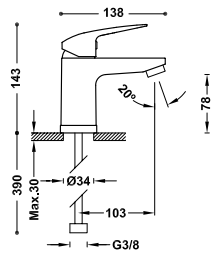

Grifo monomando para lavabo

Latiguillos de alimentación flexibles G3/8.

21610303NM

93,00

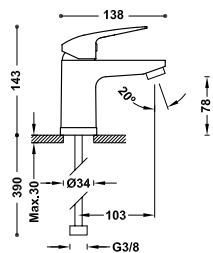

Grifo monomando para lavabo con Tres-duo

Latiguillos de alimentación flexibles G3/8.

21610310

62,00

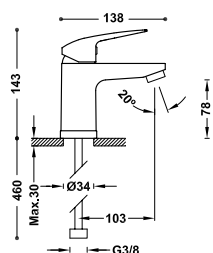

Grifo monomando ecoeficiente para lavabo

Latiguillos de alimentación flexibles G3/8.

21610410

68,00



GRIFOS PARA BIDÉ

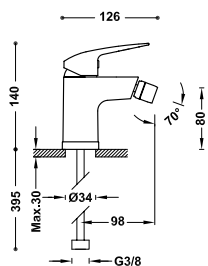

Grifo monomando para bidé
Latiguillos de alimentación flexibles G3/8.

21612010 63,00

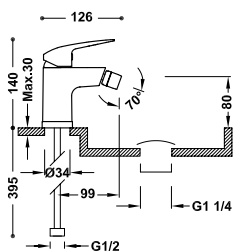

Grifo monomando para bidé con desagüe automático
Rótula orientable. Latiguillos de alimentación flexibles G3/8.

21612010DA 77,00

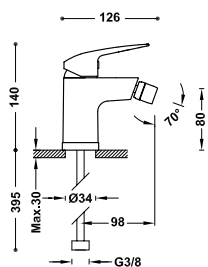

Grifo monomando para bidé
Latiguillos de alimentación flexibles G3/8.

21612010NM 97,00



GRIFOS MURALES

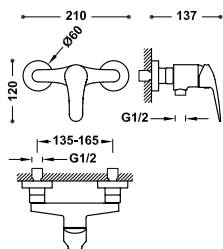

Grifo monomando mural para ducha
Sin complementos.

21626710 75,00

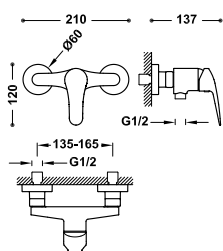

Grifo monomando mural para ducha
Ducha de mano anticalcárea. Soporte orientable para ducha de mano. Flexo metálico.

21616710 89,00
21616710NM 138,00



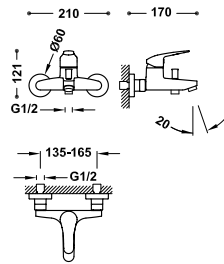

Grifo monomando mural para bañera y ducha
Sin complementos.

■ 21627010 98,00

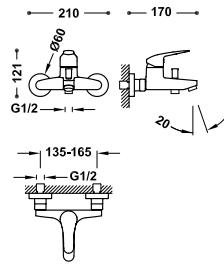

Grifo monomando mural para bañera y ducha

Ducha de mano anticalcárea. Soporte orientable para ducha de mano. Flexo metálico.

■ 21617010 112,00
■ 21617010NM 174,00

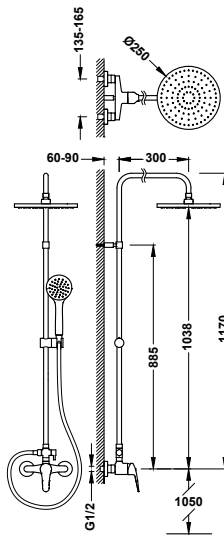

Conjunto de grifo monomando mural de 2 vías para ducha

- Con inversor integrado en la barra de ducha.
- Rociador de ducha orientable: Ø 250 mm.
- Soporte deslizante y orientable para ducha de mano.
- Ducha de mano anticalcárea.
- Flexo metálico.

■ 21619110 289,00

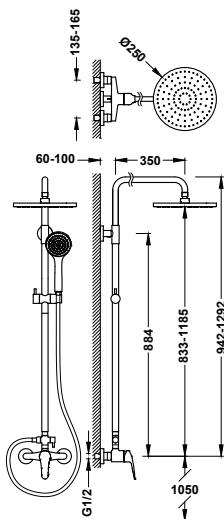

Conjunto de grifo monomando mural de 2 vías para ducha

- Con inversor integrado en la barra de ducha.
- Rociador de ducha orientable: Ø 250 mm.
- Barra de ducha telescópica.
- Soporte deslizante y orientable para ducha de mano.
- Ducha de mano anticalcárea.
- Flexo metálico.

■ 21631221 389,00

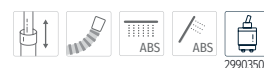

GRIFOS EMPOTRADOS

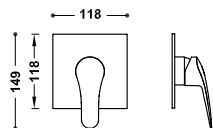

Pieza vista para caja empotrada de 1 vía Rapid-box

21627810

58,00

Sólo parte vista. Incluye placa embellecedora, mando, casquillo y tornillo de fijación oculto. Completar con la caja empotrada Rapid-box ref.: 20827810.



Caja empotrada de 1 vía Rapid-box con grifo monomando para ducha

20827810

→405

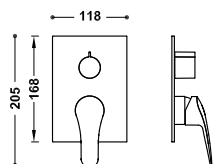

Pieza vista para caja empotrada de 2 vías Rapid-box

21628110

74,00

Sólo parte vista. Incluye placa embellecedora, mando, volante distribuidor y tornillo de fijación oculto. Completar con la caja empotrada Rapid-box ref.: 20828110.



Caja empotrada de 2 vías Rapid-box con grifo monomando para ducha y bañera

20828110

→405

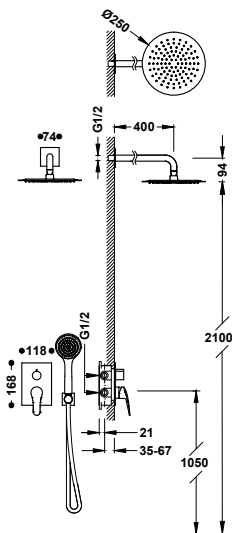

Kit de grifo monomando empotrado de 2 vías Rapid-box para ducha

21628004

344,00

- Cuerpo empotrado incluido.
- Distribuidor cerámico de 2 vías.
- Brazo a pared con rociador de ducha orientable y de acero inoxidable: Ø 250 mm.
- Soporte para ducha de mano con toma de agua a pared.
- Ducha de mano anticalcárea: Ø 100 mm.
- Flexo metálico.



29903508

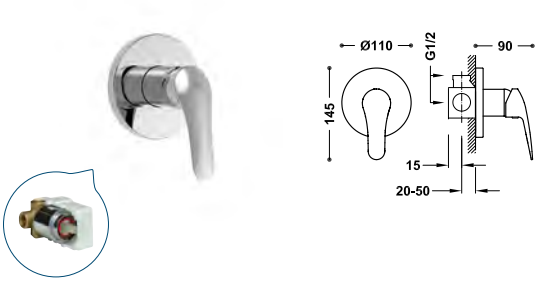

Grifo monomando empotrado de 1 vía para ducha
Cuerpo empotrado incluido.

■ 21617701 90,00



9134592

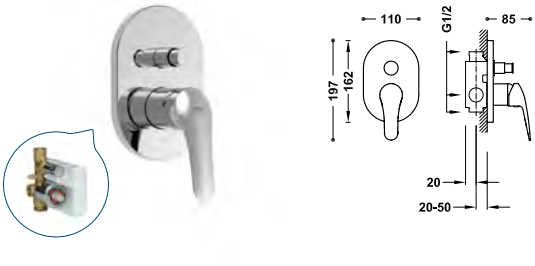

Grifo monomando empotrado de 2 vías para bañera y ducha
Cuerpo empotrado incluido. Inversor de 2 vías.

■ 21618001 126,00



9134592

GRIFOS TERMOSTÁTICOS MURALES

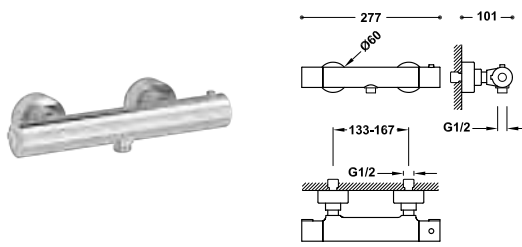

Grifo termostático mural para ducha
Sin complementos.

■ 21616401 139,00
■ 21616401NM 215,00

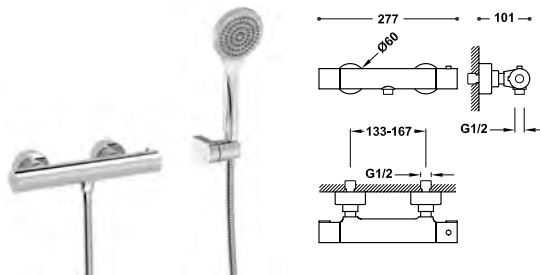

Grifo termostático mural para ducha
Ducha de mano anticalcárea: Ø 100 mm. Soporte orientable para ducha de mano. Flexo metálico.

■ 21616409 153,00
■ 21616409NM 238,00

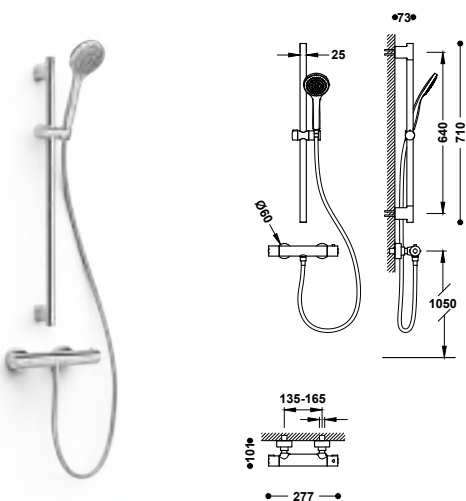

Kit de grifo termostático mural para ducha

- Barra de ducha: long. 640 mm.
- Soporte deslizante y orientable para ducha de mano.
- Ducha de mano anticalcárea: Ø 100 mm.
- Flexo metálico.

■ 21619601 249,00
■ 21619601NM 363,00



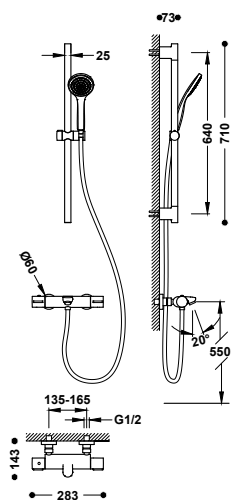

Kit de grifo termostático mural para bañera y ducha

21619602

302,00

- Barra de ducha: long. 640 mm.
- Soporte deslizante y orientable para ducha de mano.
- Ducha de mano anticalcárea: Ø 100 mm.
- Flexo metálico.

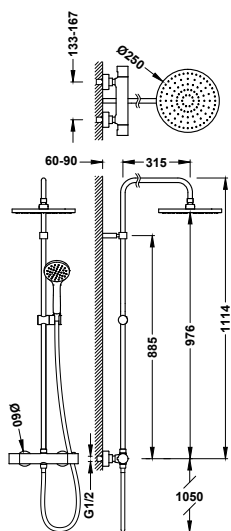

Conjunto de grifo termostático mural de 2 vías para ducha

21639301

315,00

- Con inversor integrado en el regulador de caudal.
- Volante redondo de ABS.
- Rociador de ducha orientable: Ø 250 mm.
- Soporte deslizante y orientable para ducha de mano.
- Ducha de mano anticalcárea: Ø 100 mm.
- Flexo metálico.

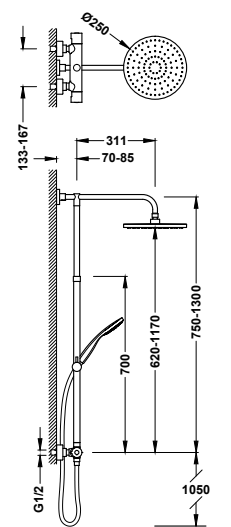

Conjunto de grifo termostático mural de 2 vías para ducha

21639302NM

488,00

- Con inversor integrado en el regulador de caudal.
- Volante redondo de ABS.
- Barra de ducha de longitud variable hasta su fijación.
- Rociador de ducha orientable: Ø 250 mm.
- Soporte deslizante y orientable para ducha de mano.
- Ducha de mano anticalcárea: Ø 100 mm.
- Flexo satinado.



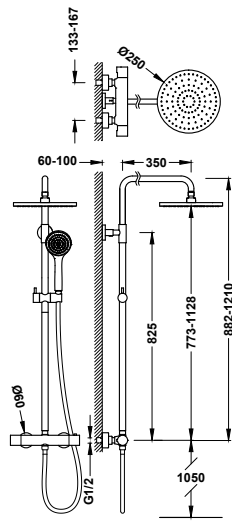

Conjunto de grifo termostático mural de 2 vías para ducha

■ 21639521

405,00

- Con inversor integrado en el regulador de caudal.
- Volante redondo de ABS.
- Barra de ducha telescópica.
- Rociador de ducha orientable: Ø 250 mm.
- Soporte deslizante y orientable para ducha de mano.
- Ducha de mano anticalcárea: Ø 100 mm.
- Flexo metálico.

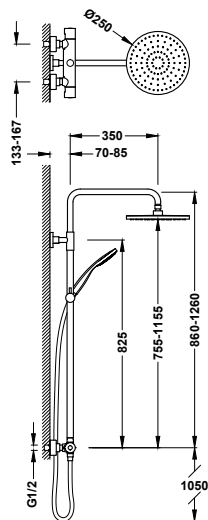

Conjunto de grifo termostático mural de 2 vías para ducha

■ 21639502NM

628,00

- Con inversor integrado en el regulador de caudal.
- Barra de ducha telescópica.
- Rociador de ducha orientable: Ø 250 mm.
- Soporte deslizante y orientable para ducha de mano.
- Ducha de mano anticalcárea: Ø 100 mm.
- Flexo satinado.



GRIFOS TERMOSTÁTICOS EMPOTRADOS

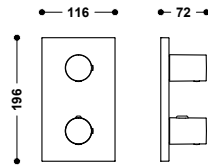

Pieza vista para caja empotrada de 2 vías Therm-box

Sólo parte vista. Volante redondo de ABS. Incluye placa embellecedora, mando y volante distribuidor. Completar con la caja empotrada Therm-box ref.: 20785001.

■ 21625001	85,00
■ 21625001NM	130,00



Caja empotrada de 2 vías Therm-box con grifo termostático para ducha y bañera

20785001
[→ 405](#)

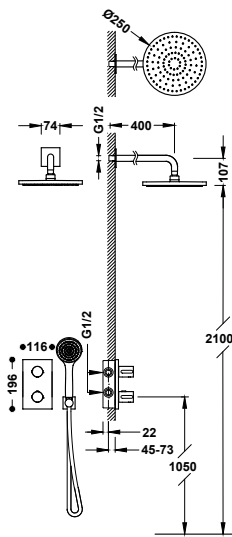

Kit de grifo termostático empotrado de 2 vías Therm-box para ducha

- Cuerpo empotrado incluido.
- Volante redondo de ABS con control de temperatura.
- Distribuidor cerámico de 2 vías.
- Brazo a pared con rociador de ducha orientable: Ø 250 mm.
- Soporte para ducha de mano con toma de agua a pared.
- Ducha de mano anticalcárea.
- Flexo metálico.

■ 21625004	498,00
■ 21625004NM	772,00













BASE

Con la serie Base se puede equipar el baño con lo esencial ya que cada grifo de esta serie cumple una función y ha sido diseñado para combinar la eficiencia y seguridad con la simpleza de su funcionalidad. Base es básicamente simple. Básicamente única.

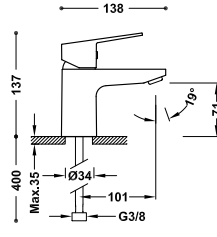

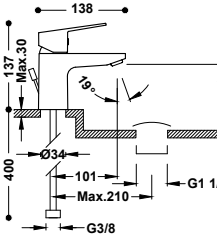
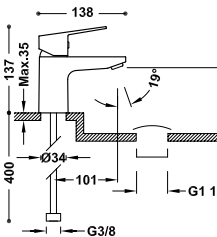

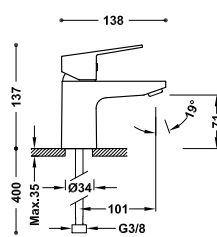
GRIFOS PARA LAVABO

		<p>Grifo monomando para lavabo</p> <p>Latiguillos de alimentación flexibles G3/8.</p>	<p>21510303 53,00</p>
		<p>Grifo monomando para lavabo con desagüe automático</p> <p>Latiguillos de alimentación flexibles G3/8.</p>	<p>21510303DA 69,00</p>
		<p>Grifo monomando para lavabo con válvula desagüe Click-clack</p> <p>Latiguillos de alimentación flexibles G3/8.</p>	<p>21510303D 63,00</p>
		<p>Grifo monomando para lavabo con Tres-duo</p> <p>Latiguillos de alimentación flexibles G3/8.</p>	<p>21510310 56,00</p>
		<p>Grifo monomando para lavabo con Tres-duo y válvula desagüe Click-clack</p> <p>Latiguillos de alimentación flexibles G3/8.</p>	<p>21510310D 66,00</p>



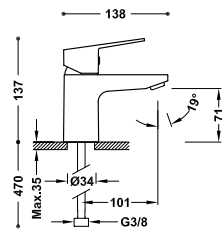

Grifo monomando ecoeficiente para lavabo
Latiguillos de alimentación flexibles G3/8.

■ 21510410

62,00

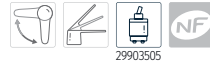

29903505

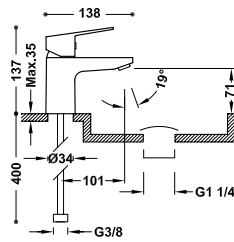

Grifo monomando ecoeficiente para lavabo con válvula desagüe Click-clack
Latiguillos de alimentación flexibles G3/8.

■ 21510410D

72,00



29903505

GRIFOS PARA BIDÉ

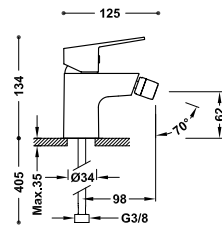

Grifo monomando para bidé
Latiguillos de alimentación flexibles G3/8.

■ 21512010

56,00



29903504

IA

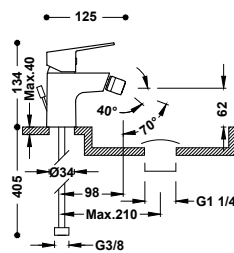

Grifo monomando para bidé con desagüe automático
Rótula orientable. Latiguillos de alimentación flexibles G3/8.

■ 21512010DA

70,00



29903504

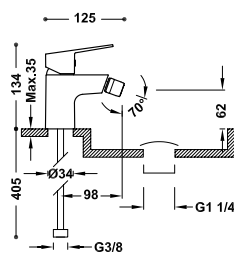

Grifo monomando para bidé con válvula desagüe Click-clack
Latiguillos de alimentación flexibles G3/8.

■ 21512010D

66,00



29903504

GRIFOS MURALES

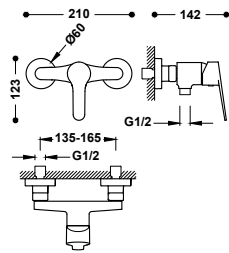

Grifo monomando mural para ducha
Sin complementos.

21526710

72,00

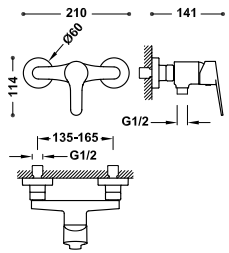

Grifo monomando mural para ducha
Ducha de mano anticálcarea. Soporte articulado para ducha de mano. Flexo metálico.

21516710

87,00

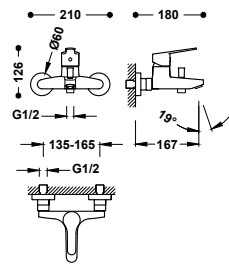

Grifo monomando mural para bañera y ducha
Sin complementos.

21527010

88,00

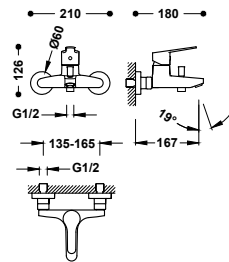

Grifo monomando mural para bañera y ducha
Ducha de mano anticálcarea. Soporte articulado para ducha de mano. Flexo metálico.

21517010

102,00



GRIFOS EMPOTRADOS

Pieza vista para caja empotrada de 1 vía Rapid-box

21527810

58,00

Sólo parte vista. Incluye placa embellecedora, mando, casquillo y tornillo de fijación oculto. Completar con la caja empotrada Rapid-box ref: 20827810.

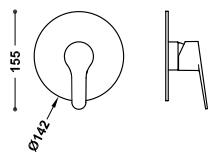

Caja empotrada de 1 vía Rapid-box con grifo monomando para ducha

20827810

[→405](#)

Pieza vista para caja empotrada de 2 vías Rapid-box

21528110

74,00

Sólo parte vista. Incluye placa embellecedora, mando, volante distribuidor y tornillo de fijación oculto. Completar con la caja empotrada Rapid-box ref: 20828110.

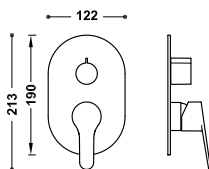

Caja empotrada de 2 vías Rapid-box con grifo monomando para ducha y bañera

20828110

[→405](#)

Grifo monomando empotrado de 1 vía para ducha

21517701

82,00

Cuerpo empotrado incluido.

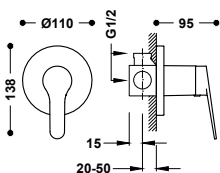

Grifo monomando empotrado de 2 vías para bañera y ducha

21518001

118,00

Cuerpo empotrado incluido. Inversor de 2 vías.

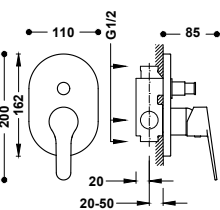

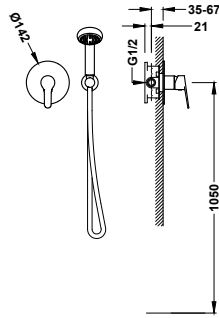

Kit de grifo monomando empotrado de 1 vía Rapid-box para ducha

21527702

209,00

- Cuerpo empotrado incluido.
- Soporte para ducha de mano con toma de agua a pared.
- Ducha de mano anticalcárea.
- Flexo metálico.

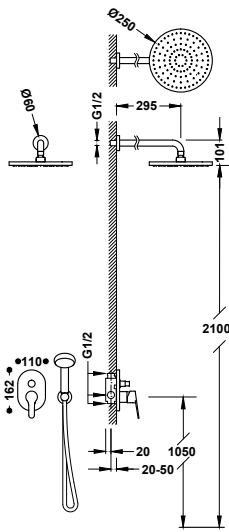

Kit de grifo monomando empotrado de 2 vías para ducha

21599002

248,00

- Cuerpo empotrado incluido.
- Inversor de 2 vías.
- Brazo a pared con rociador de ducha orientable: Ø 250 mm.
- Soporte para ducha de mano con toma de agua a pared.
- Ducha de mano anticalcárea.
- Flexo metálico.



GRIFOS TERMOSTÁTICOS MURALES

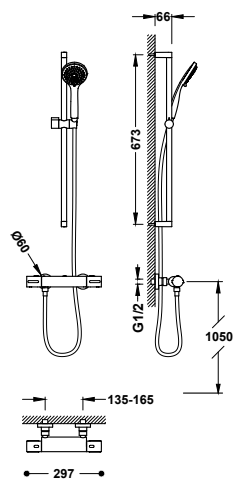

Kit de grifo termostático mural Over-wall para ducha

19019601

259,00

- Volante redondo de ABS.
- Barra de ducha: long. 673 mm y Ø 20,6 mm.
- Soporte deslizante y orientable para ducha de mano.
- Ducha de mano anticalcárea: Ø 100 mm. (3 tipos de chorro).
- Flexo metálico.



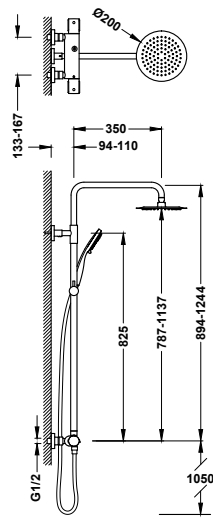

Conjunto de grifo termostático mural Over-wall de 2 vías para ducha

19038710

420,00

- Con inversor integrado en el regulador de caudal.
- Barra de ducha telescópica.
- Volante redondo de ABS.
- Rociador de ducha orientable de acero inoxidable: Ø200 mm.
- Soporte deslizante y orientable para ducha de mano.
- Ducha de mano anticalcárea: Ø100 mm. (3 tipos de chorro).
- Flexo metálico.

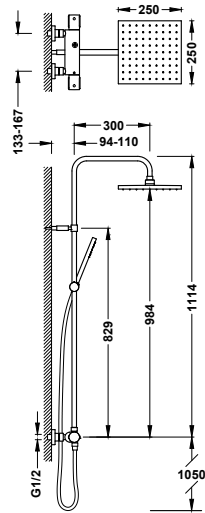
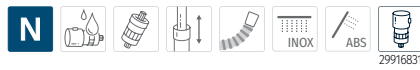

Conjunto de grifo termostático mural Over-wall de 2 vías para ducha

19039317

429,00

- Con inversor integrado en el regulador de caudal.
- Volante redondo de ABS.
- Rociador de ducha orientable: 250x250 mm.
- Soporte deslizante y orientable para ducha de mano.
- Ducha de mano anticalcárea.
- Flexo metálico.



GRIFOS TERMOSTÁTICOS EMPOTRADOS

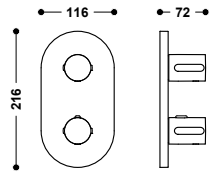

Pieza vista para caja empotrada de 2 vías Therm-box

21525001

85,00

Sólo parte vista. Volante redondo de ABS. Incluye placa embellecedora, mando y volante distribuidor. Completar con la caja empotrada Therm-box ref: 20785001.



Caja empotrada de 2 vías Therm-box con grifo termostático para ducha y bañera

20785001

→405

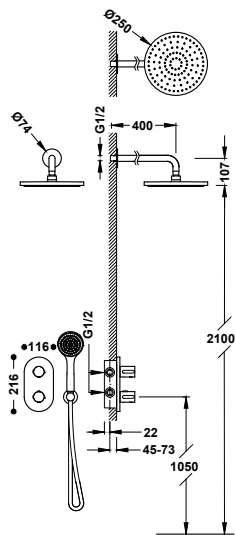

Kít de grifo termostático empotrado de 2 vías Therm-box para ducha

21525004

435,00

- Cuerpo empotrado incluido.
- Volante redondo de ABS con control de temperatura.
- Distribuidor cerámico de 2 vías.
- Brazo a pared con rociador de ducha orientable: Ø 250 mm.
- Soporte para ducha de mano con toma de agua a pared.
- Ducha de mano anticalcárea.
- Flexo metálico.

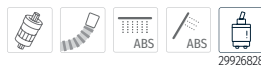

29926828



ESE-23

La serie bimando ESE-23 es la alternativa asequible para la grifería básica. Los volantes retro con indicadores de agua caliente o fría y sus cuerpos condensados caracterizan una serie con las piezas principales para una vivienda.

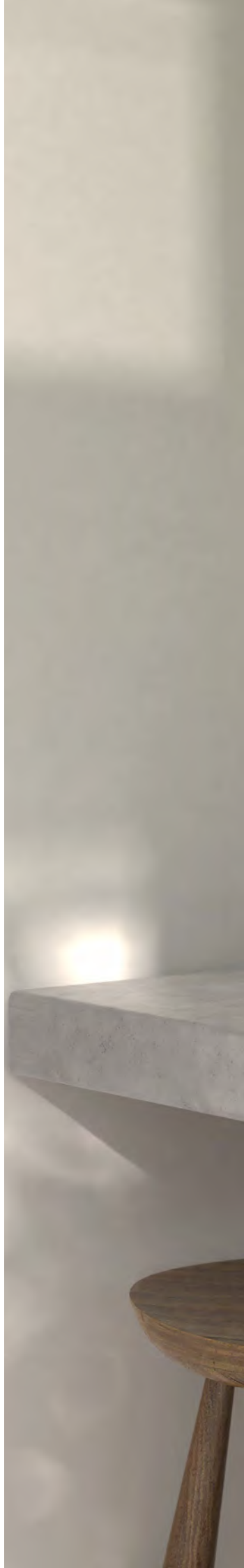



GRIFOS PARA LAVABO

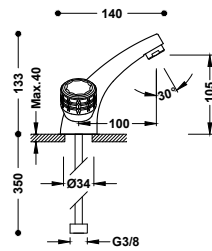

Grifo bimando para lavabo

Latiguillos de alimentación flexibles G3/8.

■ 123103

108,00



9134284

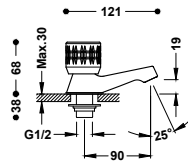

Grifo de 1 agua para lavabo

Conexión roscada macho de G1/2.

* ■ 123100F

36,00

* ■ 123100C

36,00



9134284

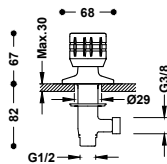

Grifo lateral sin caño para lavabo

* ■ 123510F

59,00

* ■ 123510C

59,00



9134285

GRIFOS PARA BIDÉ

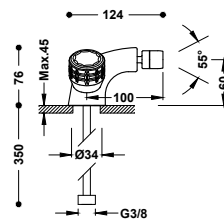

Grifo bimando para bidé

Latiguillos de alimentación flexibles G3/8.

■ 123120

111,00



9134284

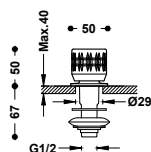

Grifo lateral sin caño para bidé

Conexión roscada macho de G1/2.

* ■ 123125F

40,00

* ■ 123125C

40,00



9134284

GRIFOS MURALES

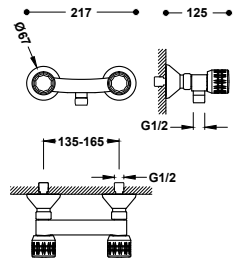

Grifo bimando mural para ducha

■ 123167

118,00

Ducha de mano anticalcárea. Soporte orientable para ducha de mano. Flexo metálico reforzado.



9134284

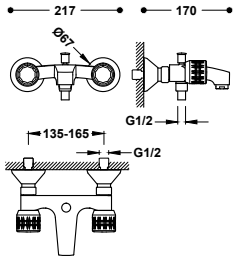

Grifo bimando mural para bañera y ducha

■ 123170

160,00

Ducha de mano anticalcárea. Soporte orientable para ducha de mano. Flexo metálico reforzado.



9134284

GRIFOS PARA VARIOS USOS

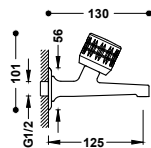

Grifo mural de 1 agua para office o lavadero

* ■ 123520F

36,00

Conexión roscada macho de G1/2.

* ■ 123520C

36,00



9134283

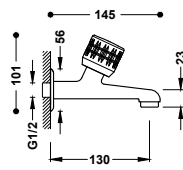

Grifo mural de 1 agua para office o lavadero

* ■ 02352001F

43,00

Conexión roscada macho de G1/2.

* ■ 02352001C

43,00



9134283

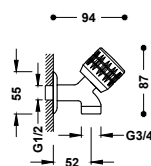

Grifo mural de 1 agua para lavadora

* ■ 123500F

25,00

Conexión roscada macho de G1/2.

* ■ 123500C

25,00



9134283



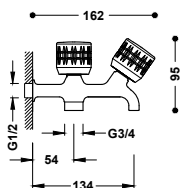

Grifo mural doble de 1 agua para lavadora

■ 123515

43,00

Salida 1: Conexión roscada macho: 3/4". Salida 2: a lavadero.



9134283

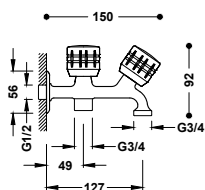

Grifo mural doble de 1 agua para lavadora

■ 02351501

46,00

Salida 1 y 2: Conexión roscada macho: 3/4".



9134283

LLAVES DE PASO

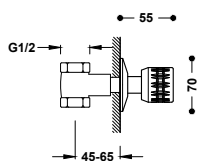

Llave de paso empotrada 1/2"

* ■ 123155F

33,00

Conexión roscada hembra: 1/2".

* ■ 123155C

33,00



9134286

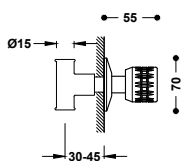

Llave de paso empotrada Ø 15 mm

* ■ 123511F

31,00

Conexión soldada hembra: Ø 15 mm.

* ■ 123511C

31,00



9134286

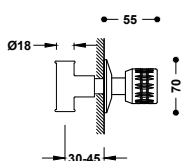

Llave de paso empotrada Ø 18 mm

* ■ 123512F

30,00

Conexión soldada hembra: Ø 18 mm.

* ■ 123512C

30,00



9134286

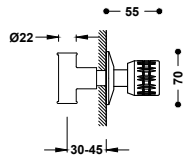

Llave de paso empotrada \varnothing 22 mm
Conexión soldada hembra: \varnothing 22 mm.

- 123513F 29,00
- 123513C 29,00

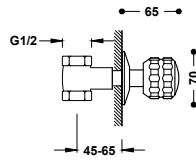

Llave de paso empotrada 1/2"
Conexión roscada hembra: 1/2".

- 13315510F 62,00
- 13315510C 62,00

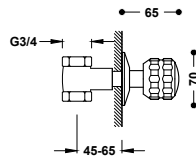

Llave de paso empotrada 3/4"
Conexión roscada hembra: 3/4".

- 13315710F 74,00
- 13315710C 74,00

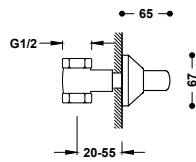

Llave de paso empotrada con regulación oculta 1/2"
Conexión roscada hembra: 1/2".

- 133516 56,00

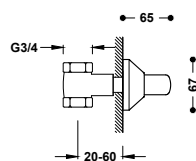

Llave de paso empotrada con regulación oculta 3/4"
Conexión roscada hembra: 3/4".

- 133517 58,00







ESPACIO DE DUCHA

ELECTRÓNICOS

258 Shower Technology

TERMOSTÁTICOS

270 Empotrados B-system

280 Empotrados Therm-box

294 Murales Over-wall

MONOMANDOS

318 Empotrados Rapid-box

338 Murales



SHOWER TECHNOLOGY

Equipar la ducha o bañera con Shower technology da mucha más satisfacción. Tres ha mejorado su innovación electrónica para tener un control absoluto de la ducha. La ducha está al servicio del usuario ya que integra nuevas capacidades para aumentar su seguridad, el ahorro de agua y la comodidad para ducharse cuando todo esté listo.







SHOWER TECHNOLOGY

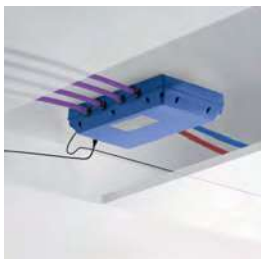
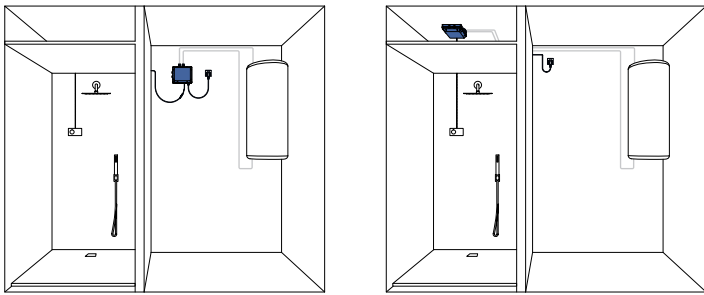

La centralita termostática electrónica se puede instalar hasta un máximo de **10 metros de distancia** de la pantalla de control.



La temperatura se encuentra en **38°C** cuando se abre inicialmente. Su límite es 46°C como máximo. El nivel de temperatura seleccionada se indica numéricamente y en escala de colores.



Sistema empotrado totalmente **estanco y antihumedades** con juntas Schlüter.



El grifo se parará cuando llegue a la **temperatura programada** y la ducha estará preparada para que entres cuando quieras.



La pantalla de control es totalmente **hermética**, con iluminación en los botones en funcionamiento y con acabado en blanco o en negro.



Incluye un programa para **prevenir la legionela** (5 minutos a 60°C) o directamente para desinfectar (10 minutos a 60°C).

KITS DE 2 VÍAS

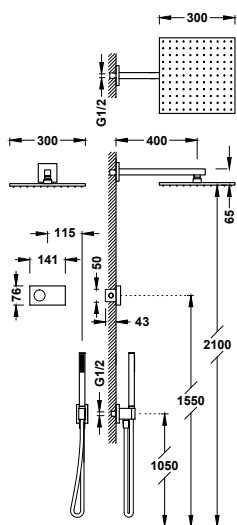

Kit de grifo termostático electrónico empotrado de 2 vías Shower technology para ducha

- Control electrónico incluido con juntas antihumedad Schlüter.
- Centralita termostática electrónica incluida (2 vías).
- Brazo a pared con rociador de ducha orientable y de acero inoxidable: 300x300 mm.
- Soporte para ducha de mano con toma de agua a pared.
- Ducha de mano anticalcárea de latón.
- Flexo satinado.



	09286563	1.242,00
	09286563OM	1.831,00
	09286563OPM	1.831,00
	09288563NM	1.346,00

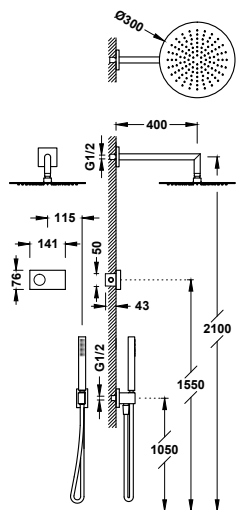

Kit de grifo termostático electrónico empotrado de 2 vías Shower technology para ducha

- Control electrónico incluido con juntas antihumedad Schlüter.
- Centralita termostática electrónica incluida (2 vías).
- Brazo a pared con rociador de ducha orientable y de acero inoxidable: Ø 300 mm.
- Soporte para ducha de mano con toma de agua a pared.
- Ducha de mano anticalcárea de latón.
- Flexo satinado.



	09286558	1.195,00
	09286558OM	1.766,00
	09286558OPM	1.766,00
	09288558NM	1.301,00

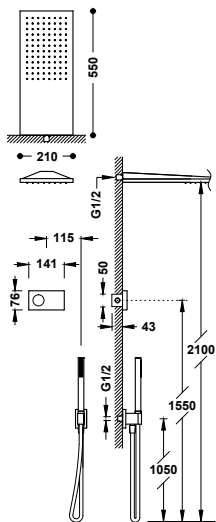

Kit de grifo termostático electrónico empotrado de 2 vías Shower technology para ducha

- Control electrónico incluido con juntas antihumedad Schlüter.
- Centralita termostática electrónica incluida de 2 vías.
- Rociador de ducha a pared de acero inoxidable: 210x550 mm.
- Soporte para ducha de mano con toma de agua a pared.
- Ducha de mano anticalcárea de latón.
- Flexo satinado.



	09286551	1.384,00
	09286551OM	2.357,00
	09286551OPM	2.357,00
	09288551NM	1.718,00

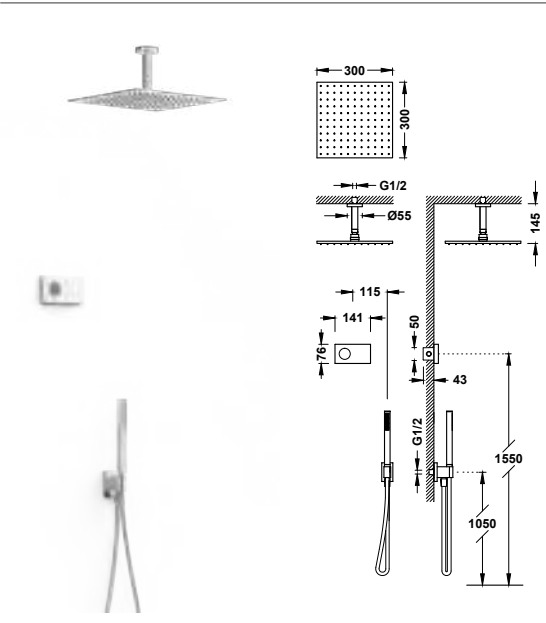

Kit de grifo termostático electrónico empotrado de 2 vías Shower technology para ducha

- Control electrónico incluido con juntas antihumedad Schlüter.
- Centralita termostática electrónica incluida (2 vías).
- Brazo a techo con rociador de ducha orientable y de acero inoxidable: 300x300 mm.
- Soporte para ducha de mano con toma de agua a pared.
- Ducha de mano anticalcárea de latón.
- Flexo satinado.

	09286564	1.190,00
	09286564OM	1.757,00
	09286564OPM	1.757,00
	09288564NM	1.296,00

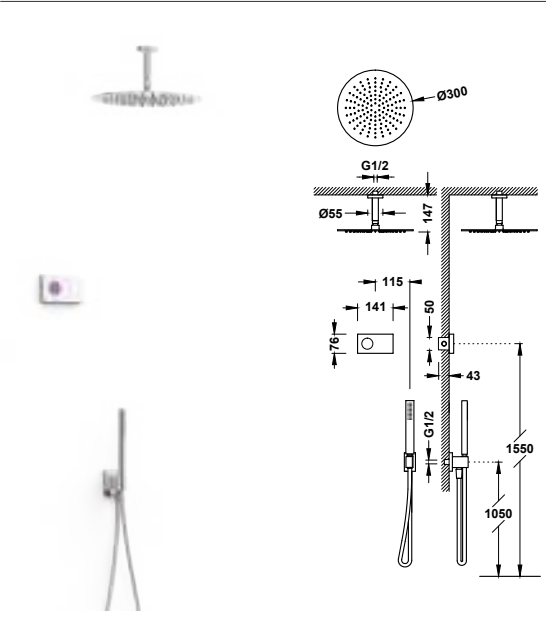

Kit de grifo termostático electrónico empotrado de 2 vías Shower technology para ducha

- Control electrónico incluido con juntas antihumedad Schlüter.
- Centralita termostática electrónica incluida (2 vías).
- Brazo a techo con rociador de ducha orientable y de acero inoxidable: Ø 300 mm.
- Soporte para ducha de mano con toma de agua a pared.
- Ducha de mano anticalcárea de latón.
- Flexo satinado.

	09286567	1.181,00
	09286567OM	1.692,00
	09286567OPM	1.692,00
	09288567NM	1.250,00

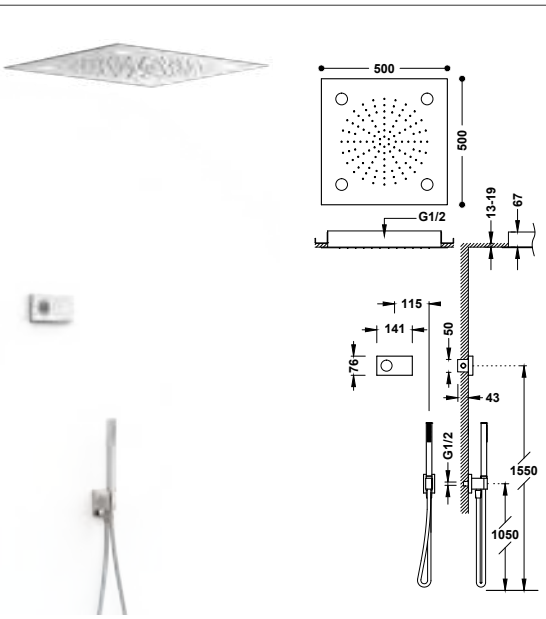

Kit de grifo termostático electrónico empotrado de 2 vías Shower technology con Cromoterapia para ducha

- Control electrónico incluido con juntas antihumedad Schlüter.
- Centralita termostática electrónica incluida (2 vías).
- Rociador de ducha empotrado a techo con Cromoterapia de acero inoxidable: 500x500 mm
- Soporte para ducha de mano con toma de agua a pared.
- Ducha de mano anticalcárea de latón.
- Flexo satinado.

	09286562	2.064,00



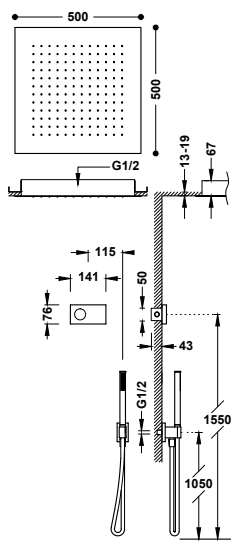

Kit de grifo termostático electrónico empotrado de 2 vías Shower technology para ducha

- Control electrónico incluido con juntas antihumedad Schlüter.
- Centralita termostática electrónica incluida (2 vías).
- Rociador de ducha empotrado a techo de acero inoxidable: 500x500 mm.
- Soporte para ducha de mano con toma de agua a pared.
- Ducha de mano anticalcárea de latón.
- Flexo satinado.

09286561 1.766,00



09288561NM 2.310,00

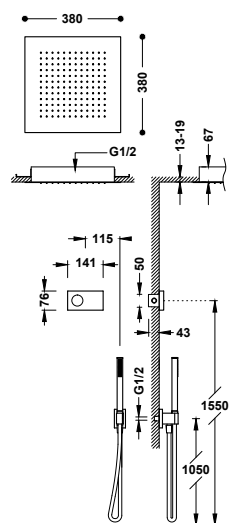

Kit de grifo termostático electrónico empotrado de 2 vías Shower technology para ducha

- Control electrónico incluido con juntas antihumedad Schlüter.
- Centralita termostática electrónica incluida (2 vías).
- Rociador de ducha empotrado a techo de acero inoxidable: 380x380 mm.
- Soporte para ducha de mano con toma de agua a pared.
- Ducha de mano anticalcárea de latón.
- Flexo satinado.

09286552 1.617,00



09288552NM 2.050,00

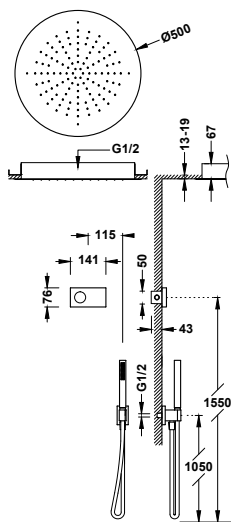

Kit de grifo termostático electrónico empotrado de 2 vías Shower technology para ducha

- Control electrónico incluido con juntas antihumedad Schlüter.
- Centralita termostática electrónica incluida (2 vías).
- Rociador de ducha empotrado a techo de acero inoxidable: Ø 500 mm.
- Soporte para ducha de mano con toma de agua a pared.
- Ducha de mano anticalcárea de latón.
- Flexo satinado.

09286557 1.766,00



09288557NM 2.300,00



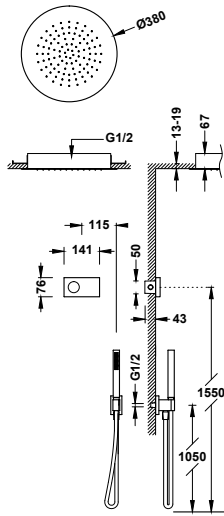

Kit de grifo termostático electrónico empotrado de 2 vías Shower technology para ducha

- Control electrónico incluido con juntas antihumedad Schlüter.
- Centralita termostática electrónica incluida (2 vías).
- Rociador de ducha empotrado a techo de acero inoxidable: Ø 380 mm.
- Soporte para ducha de mano con toma de agua a pared.
- Ducha de mano anticalcárea de latón.
- Flexo satinado.

09286555 1.592,00



09288555NM 2.039,00



Kit de grifo termostático electrónico empotrado de 2 vías Shower technology para bañera y ducha

- Control electrónico incluido con juntas antihumedad Schlüter.
- Centralita termostática electrónica incluida (2 vías).
- Caño fijo de pared con salida en cascada.
- Soporte para ducha de mano con toma de agua a pared.
- Ducha de mano anticalcárea de latón.
- Flexo satinado.

09286556 1.294,00



09288556NM 1.577,00

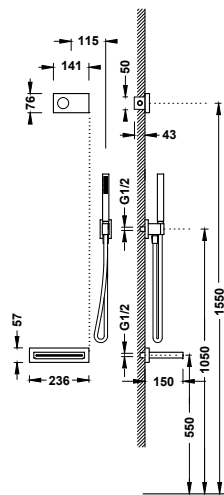

KITS DE 3 VÍAS

Kit de grifo termostático electrónico empotrado de 3 vías Shower technology para ducha

- Control electrónico incluido con juntas antihumedad Schlüter.
- Centralita termostática electrónica incluida (3 vías).
- Rociador de ducha a pared de acero inoxidable con 2 tipos de chorro (lluvia/cascada). 280x550 mm. IMPORTANTE: Montar un desagüe de >50 l/min.
- Soporte para ducha de mano con toma de agua a pared.
- Ducha de mano anticalcárea de latón.
- Flexo satinado.

09286308 1.611,00

092863080M 2.727,00

092863080PM 2.727,00



09288308NM 1.978,00

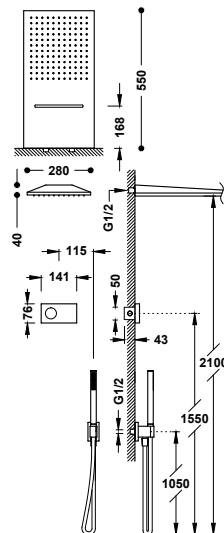

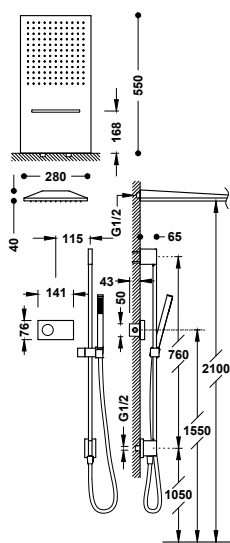

Kit de grifo termostático electrónico empotrado de 3 vías Shower technology para ducha

09286307 1.678,00



- Control electrónico incluido con juntas antihumedad Schlüter.
- Centralita termostática electrónica incluida (3 vías).
- Rociador de ducha a pared de acero inoxidable con 2 tipos de chorro (lluvia/cascada). 280x550 mm. IMPORTANTE: Montar un desagüe de >50 l/min.
- Barra deslizante para ducha con toma de agua a pared.
- Ducha de mano anticalcárea de latón.
- Flexo satinado.

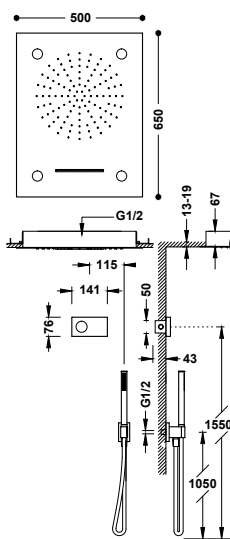

Kit de grifo termostático electrónico empotrado de 3 vías Shower technology con Cromoterapia para ducha

09286302 3.005,00



- Control electrónico incluido con juntas antihumedad Schlüter.
- Centralita termostática electrónica incluida (3 vías).
- Rociador de ducha empotrado a techo con Cromoterapia de acero inoxidable con 2 tipos de chorro (lluvia/cascada). 500x650 mm. IMPORTANTE: Montar un desagüe de >50 l/min.
- Soporte para ducha de mano con toma de agua a pared.
- Ducha de mano anticalcárea de latón.
- Flexo satinado.

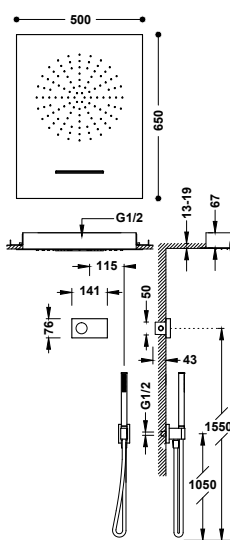

Kit de grifo termostático electrónico empotrado de 3 vías Shower technology para ducha

09286304 2.249,00



- Control electrónico incluido con juntas antihumedad Schlüter.
- Centralita termostática electrónica incluida (3 vías).
- Rociador de ducha empotrado a techo de acero inoxidable con 2 tipos de chorro (lluvia/cascada). 500x650 mm. IMPORTANTE: Montar un desagüe de >50 l/min.
- Soporte para ducha de mano con toma de agua a pared.
- Ducha de mano anticalcárea de latón.
- Flexo satinado.



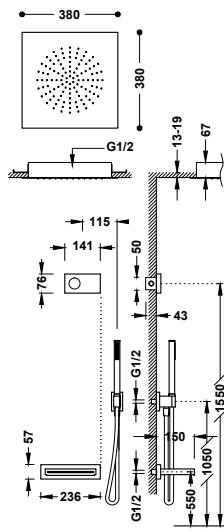

Kit de grifo termostático electrónico empotrado de 3 vías Shower technology para bañera y ducha

- Control electrónico incluido con juntas antihumedad Schlüter.
- Centralita termostática electrónica incluida (3 vías).
- Rociador de ducha empotrado a techo de acero inoxidable: 380x380 mm. **IMPORTANTE:** Montar un desagüe de >50 l/min.
- Caño fijo de pared con salida en cascada.
- Soporte para ducha de mano con toma de agua a pared.
- Ducha de mano anticalcárea de latón.
- Flexo satinado.

09286315 2.006,00



09288315NM 2.649,00



KITS DE 4 VÍAS

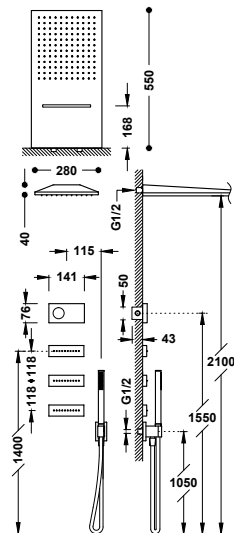

Kit de grifo termostático electrónico empotrado de 4 vías Shower technology para ducha

- Control electrónico incluido con juntas antihumedad Schlüter.
- Centralita termostática electrónica incluida (4 vías).
- Rociador de ducha a pared de acero inoxidable con 2 tipos de chorro (lluvia/cascada). 280x550 mm. **IMPORTANTE:** Montar un desagüe de >50 l/min.
- 3 jets empotrados de hidromasaje de latón.
- Soporte para ducha de mano con toma de agua a pared.
- Ducha de mano anticalcárea de latón.
- Flexo satinado.

09286408 2.224,00



09288408NM 2.896,00

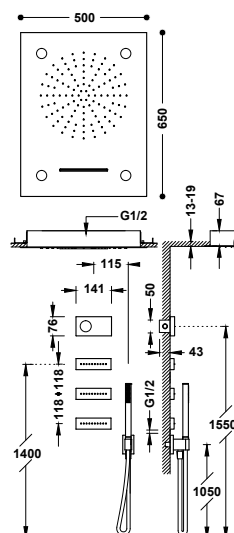

Kit de grifo termostático electrónico empotrado de 4 vías Shower technology con Cromoterapia para ducha

- Control electrónico incluido con juntas antihumedad Schlüter.
- Centralita termostática electrónica incluida (4 vías).
- Rociador de ducha empotrado a techo con Cromoterapia de acero inoxidable con 2 tipos de chorro (lluvia/cascada). 500x650 mm. **IMPORTANTE:** Montar un desagüe de >50 l/min.
- 3 jets empotrados de hidromasaje de latón.
- Soporte para ducha de mano con toma de agua a pared.
- Ducha de mano anticalcárea de latón.
- Flexo satinado.

09286402 3.618,00



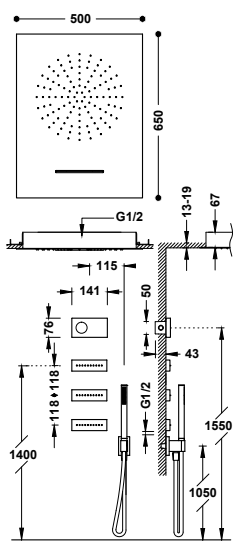

Kit de grifo termostático electrónico empotrado de 4 vías Shower technology para ducha

- Control electrónico incluido con juntas antihumedad Schlüter.
- Centralita termostática electrónica incluida (4 vías).
- Rociador de ducha empotrado a techo de acero inoxidable con 2 tipos de chorro (lluvia/cascada). 500x650 mm. IMPORTANTE: Montar un desagüe de >50 l/min.
- 3 jets empotrados de hidromasaje de latón.
- Soporte para ducha de mano con toma de agua a pared.
- Ducha de mano anticalcárea de latón.
- Flexo satinado.

09286404 2.862,00



09288404NM 3.756,00



PANTALLA DE CONTROL

COMPLETA TU DUCHA ELECTRÓNICA

Adquiere la pantalla con centralita termostática y complete la ducha con los elementos que necesite según la cantidad de vías de agua que ha elegido.

* Es obligatoria la instalación de complementos de ducha de Tres para garantizar su buen funcionamiento.



+



492 862 99 - 492 882 99

•

•

492 863 98 - 492 883 98

•

•

•

492 863 99 - 492 883 99

•

•

•

492 864 99 - 492 884 99

•

•

•

•

-371
-395

-354

-398

-499

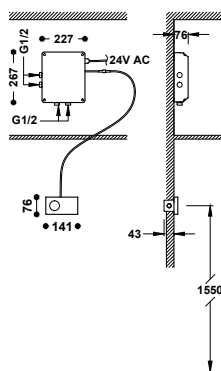

Control termostático electrónico empotrado de 2 vías Shower technology

- Control electrónico incluido con juntas antihumedad Schlüter.
- Centralita termostática electrónica incluida (2 vías).
- Temperatura mínima disponible inferior a los 25°C.
- Sistema puesta a punto: Preparación de la temperatura deseada.
- Con programas antilegionela.

49286299 * 1.040,00

49288299 * 1.040,00



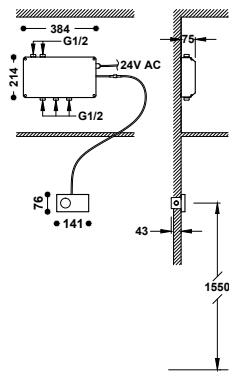

Control termostático electrónico empotrado de 3 vías Shower technology

	49286398 *	1.113,00
	49288398 *	1.113,00

- Control electrónico incluido con juntas antihumedad Schlüter.
- Centralita termostática electrónica incluida (3 vías).
- Temperatura mínima disponible inferior a los 25°C.
- Sistema puesta a punto: Preparación de la temperatura deseada.
- Con programas antilegionela.

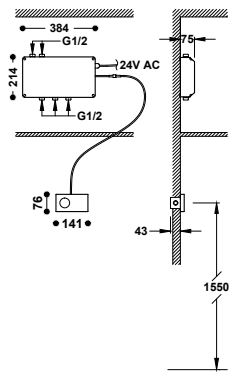
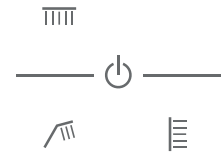

Control termostático electrónico empotrado de 3 vías Shower technology

	49286399 *	1.113,00
	49288399 *	1.113,00

- Control electrónico incluido con juntas antihumedad Schlüter.
- Centralita termostática electrónica incluida (3 vías).
- Temperatura mínima disponible inferior a los 25°C.
- Sistema puesta a punto: Preparación de la temperatura deseada.
- Con programas antilegionela.

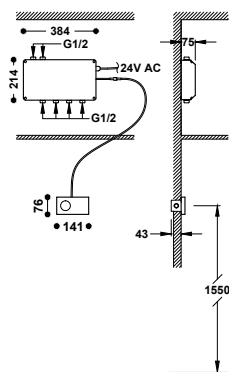
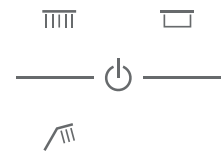

Control termostático electrónico empotrado de 4 vías Shower technology

	49286499 *	1.187,00
	49288499 *	1.187,00

- Control electrónico incluido con juntas antihumedad Schlüter.
- Centralita termostática electrónica incluida (4 vías).
- Temperatura mínima disponible inferior a los 25°C.
- Sistema puesta a punto: Preparación de la temperatura deseada.
- Con programas antilegionela.





B-SYSTEM

La colección de termostáticas empotradas B-system se caracteriza por su diseño refinado de líneas sobrias. La caja empotrada interior permite una instalación más limpia y simple. B-system es elegancia y confort en la ducha.







B-SYSTEM



La caja empotrada está incluida en cada pieza vista (no se suministra por separado).



La caja empotrada permite **instalarse por delante o por detrás de la pared**, tanto en paredes de obra como paredes ligeras de cartón y yeso (tipo Pladur).



Solo se necesita un **mínimo de 66 mm de profundidad** para la instalación de la caja empotrada.



Las piezas vistas tienen **poca profundidad**, permitiendo ganar más espacio útil dentro de la ducha.

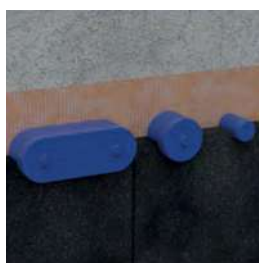

La caja aísla la transmisión de temperatura del cuerpo de latón hacia la pared. Asimismo, al ser **estanca**, evita que en caso de fuga el agua se filtre por la pared. La junta impermeable **evita las humedades**.



Control de temperatura con **botón de seguridad** que restringe la temperatura a 38°C.



Los **amortiguadores** evitan la transmisión del ruido del grifo a la pared y a la tuberías.



De 2 a 4 salidas de agua. Con un sencillo giro del distribuidor se puede escoger la salida de agua deseada.



El cartucho garantiza un **caudal de agua constante** a la temperatura deseada de ± 1 grado ante variaciones de presión y/o temperatura. Concebido para la **desinfección de la legionela**.

GRIFOS TERMOSTÁTICOS EMPOTRADOS

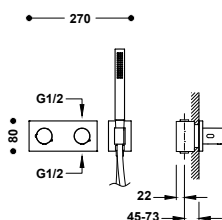

Grifo termostático empotrado de 2 vías B-system

- Cuerpo empotrado termostático de instalación horizontal incluido.
- Regulador de caudal y distribuidor cerámico de 2 vías.
- Volante redondo.
- Soporte para ducha de mano con toma de agua a pared.
- Ducha móvil anticalcárea de latón.
- Flexo satinado.

	30735201	540,00
	30735201NM	837,00
	30735201AC	837,00
	30735201KMB	837,00
	30735201OR	1.188,00
	30735201OM	1.188,00
	30735201OP	1.188,00
	30735201OPM	1.188,00

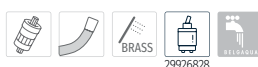

Grifo termostático empotrado de 2 vías B-system

- Cuerpo empotrado termostático de instalación horizontal incluido.
- Regulador de caudal y distribuidor cerámico de 2 vías.
- Volante cuadrado-redondo.
- Soporte para ducha de mano con toma de agua a pared.
- Ducha móvil anticalcárea de latón.
- Flexo satinado.

	30725201	560,00
	30725201NM	868,00
	30725201AC	868,00
	30725201KMB	868,00
	30725201OR	1.232,00
	30725201OM	1.232,00
	30725201OP	1.232,00
	30725201OPM	1.232,00

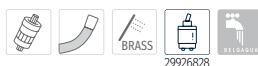
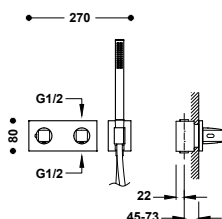

Grifo termostático empotrado de 3 vías B-system

- Cuerpo empotrado termostático de instalación horizontal incluido.
- Regulador de caudal y distribuidor de 3 vías.
- Volante redondo.
- Soporte para ducha de mano con toma de agua a pared.
- Ducha móvil anticalcárea de latón.
- Flexo satinado.

	30735301	640,00
	30735301NM	992,00
	30735301AC	992,00
	30735301KMB	992,00
	30735301OR	1.408,00
	30735301OM	1.408,00
	30735301OP	1.408,00
	30735301OPM	1.408,00

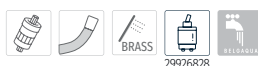
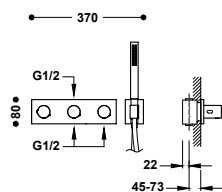

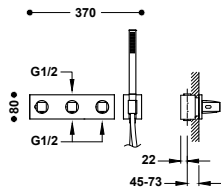

Grifo termostático empotrado de 3 vías B-system

- Cuerpo empotrado termostático de instalación horizontal incluido.
- Regulador de caudal y distribuidor de 3 vías.
- Volante cuadrado-redondo.
- Soporte para ducha de mano con toma de agua a pared.
- Ducha móvil anticalcárea de latón.
- Flexo satinado.

30725301	660,00
30725301NM	1.023,00
30725301AC	1.023,00
30725301KMB	1.023,00 N
30725301OR	1.452,00
30725301OM	1.452,00
30725301OP	1.452,00
30725301OPM	1.452,00

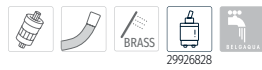

29926828

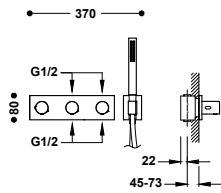

Grifo termostático empotrado de 4 vías B-system

- Cuerpo empotrado termostático de instalación horizontal incluido.
- Regulador de caudal y distribuidor de 4 vías.
- Volante redondo.
- Soporte para ducha de mano con toma de agua a pared.
- Ducha móvil anticalcárea de latón.
- Flexo satinado.

30735401	640,00
30735401NM	992,00
30735401AC	992,00
30735401KMB	992,00 N
30735401OR	1.408,00
30735401OM	1.408,00
30735401OP	1.408,00
30735401OPM	1.408,00

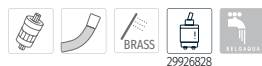

29926828

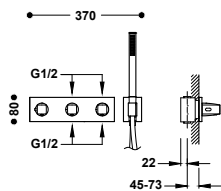

Grifo termostático empotrado de 4 vías B-system

- Cuerpo empotrado termostático de instalación horizontal incluido.
- Regulador de caudal y distribuidor de 4 vías.
- Volante cuadrado-redondo.
- Soporte para ducha de mano con toma de agua a pared.
- Ducha móvil anticalcárea de latón.
- Flexo satinado.

30725401	660,00
30725401NM	1.023,00
30725401AC	1.023,00
30725401KMB	1.023,00 N
30725401OR	1.452,00
30725401OM	1.452,00
30725401OP	1.452,00
30725401OPM	1.452,00

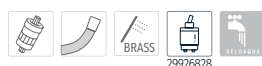

29926828

KITS DE 2 VÍAS

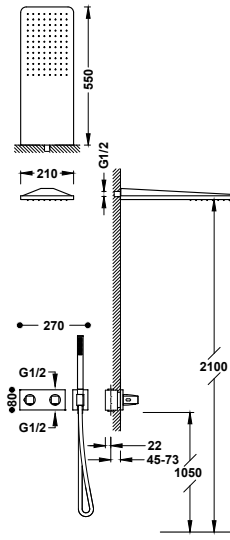

Kit de grifo termostático empotrado de 2 vías B-system para ducha

- Cuerpo empotrado termostático de instalación horizontal incluido.
- Regulador de caudal y distribuidor cerámico de 2 vías.
- Volante cuadrado-redondo.
- Rociador de ducha a pared de acero inoxidable: 210x550 mm.
- Soporte para ducha de mano con toma de agua a pared.
- Ducha de mano anticalcárea de latón.
- Flexo satinado.

30725205	1.116,00
30725205NM	1.730,00
30725205AC	1.730,00
30725205KMB	1.730,00
30725205OR	2.456,00
30725205OM	2.456,00
30725205OP	2.456,00
30725205OPM	2.456,00

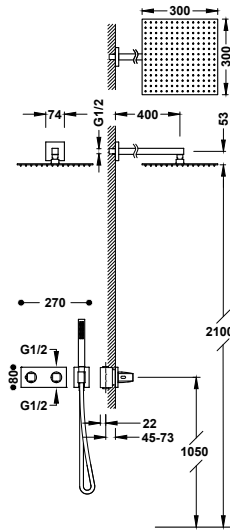

Kit de grifo termostático empotrado de 2 vías B-system para ducha

- Cuerpo empotrado termostático de instalación horizontal incluido.
- Regulador de caudal y distribuidor cerámico de 2 vías.
- Volante cuadrado-redondo.
- Brazo a pared con rociador de ducha orientable y de acero inoxidable: 300x300 mm.
- Soporte para ducha de mano con toma de agua a pared.
- Ducha de mano anticalcárea de latón.
- Flexo satinado.

30725204	782,00
30725204NM	1.210,00
30725204AC	1.210,00
30725204KMB	1.210,00
30725204OR	1.718,00
30725204OM	1.718,00
30725204OP	1.718,00
30725204OPM	1.718,00

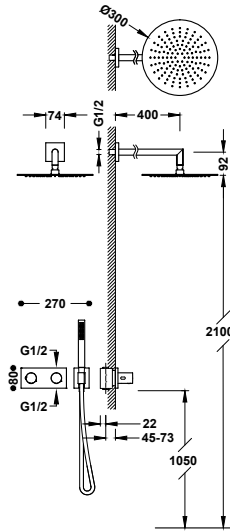

Kit de grifo termostático empotrado de 2 vías B-system para ducha

- Cuerpo empotrado termostático de instalación horizontal incluido.
- Regulador de caudal y distribuidor cerámico de 2 vías.
- Volante redondo.
- Brazo a pared con rociador de ducha orientable y de acero inoxidable: Ø 300 mm.
- Soporte para ducha de mano con toma de agua a pared.
- Ducha de mano anticalcárea de latón.
- Flexo satinado.

30735204	811,00
30735204NM	1.163,00
30735204AC	1.163,00
30735204KMB	1.163,00
30735204OR	1.651,00
30735204OM	1.651,00
30735204OP	1.651,00
30735204OPM	1.651,00



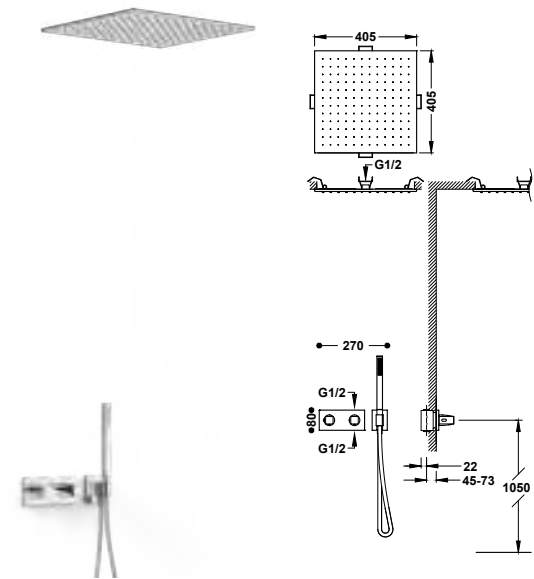

Kit de grifo termostático empotrado de 2 vías B-system para ducha

- Cuerpo empotrado termostático de instalación horizontal incluido.
- Regulador de caudal y distribuidor cerámico de 2 vías.
- Volante cuadrado-redondo.
- Rociador de ducha empotrado a techo de acero inoxidable: 405x405 mm.
- Soporte para ducha de mano con toma de agua a pared.
- Ducha de mano anticalcárea de latón.
- Flexo satinado.

30725206	1.315,00
30725206NM	1.855,00
30725206AC	1.855,00
30725206KMB	1.855,00 N
30725206OR	2.895,00
30725206OM	2.895,00
30725206OP	2.895,00
30725206OPM	2.895,00

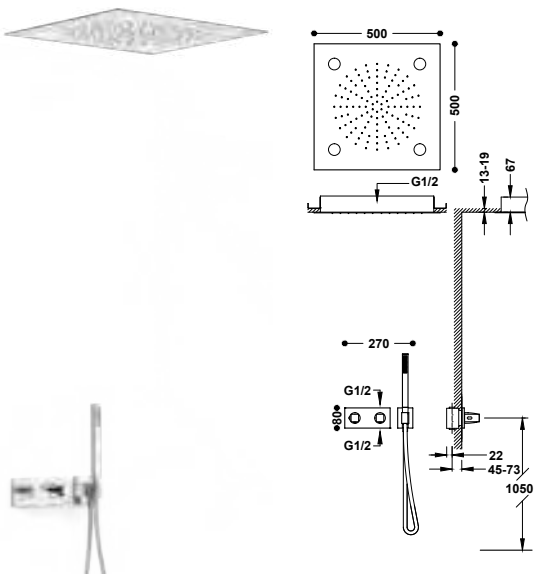

Kit de grifo termostático empotrado de 2 vías B-system para ducha

- Cuerpo empotrado termostático de instalación horizontal incluido.
- Regulador de caudal y distribuidor cerámico de 2 vías.
- Volante cuadrado-redondo.
- Rociador de ducha empotrado a techo con Cromoterapia de acero inoxidable: 500x500 mm.
- Soporte para ducha de mano con toma de agua a pared.
- Ducha de mano anticalcárea de latón.
- Flexo satinado.

30725208	1.852,00
----------	----------

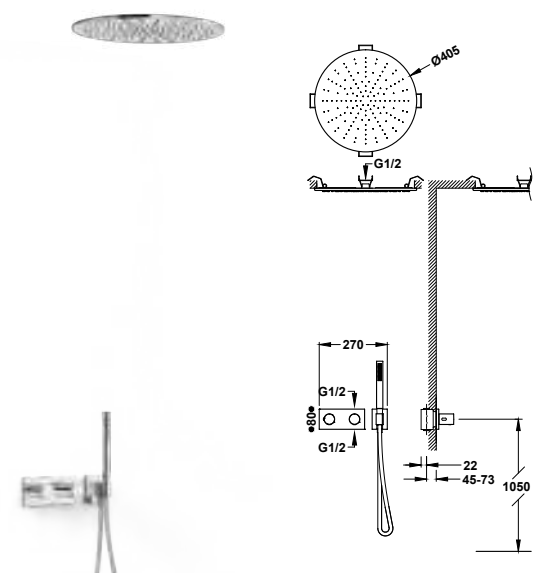

Kit de grifo termostático empotrado de 2 vías B-system para ducha

- Cuerpo empotrado termostático de instalación horizontal incluido.
- Regulador de caudal y distribuidor cerámico de 2 vías.
- Volante redondo.
- Rociador de ducha empotrado a techo de acero inoxidable: Ø 405 mm.
- Soporte para ducha de mano con toma de agua a pared.
- Ducha de mano anticalcárea de latón.
- Flexo satinado.

30735206	1.329,00
30735206NM	1.966,00
30735206AC	1.966,00
30735206KMB	1.966,00 N
30735206OR	2.790,00
30735206OM	2.790,00
30735206OP	2.790,00
30735206OPM	2.790,00



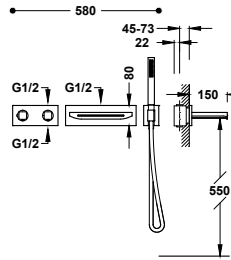

Kit de grifo termostático empotrado de 2 vías B-system para bañera y ducha

- Cuerpo empotrado termostático de instalación horizontal incluido.
- Regulador de caudal y distribuidor cerámico de 2 vías.
- Volante cuadrado-redondo.
- Caño fijo de pared con salida en cascada.
- Soporte para ducha de mano con toma de agua a pared.
- Ducha de mano anticalcárea de latón.
- Flexo satinado.

30725207	1.197,00
30725207NM	1.855,00
30725207AC	1.855,00
30725207KMB	1.855,00
30725207OR	2.633,00
30725207OM	2.633,00
30725207OP	2.633,00
30725207OPM	2.633,00



KITS DE 3 VÍAS

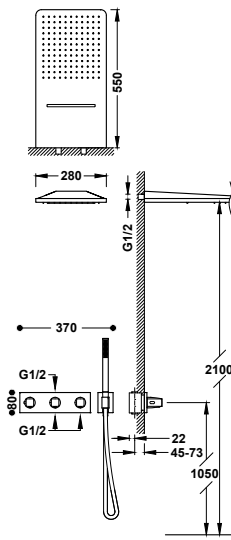

Kit de grifo termostático empotrado de 3 vías B-system para ducha

- Cuerpo empotrado termostático de instalación horizontal incluido.
- Regulador de caudal y distribuidor de 3 vías.
- Volante cuadrado-redondo.
- Rociador de ducha a pared de acero inoxidable con 2 tipos de chorro (lluvia/cascada). 280x550 mm. IMPORTANTE: Montar un desagüe de >50 l/min.
- Soporte para ducha de mano con toma de agua a pared.
- Ducha de mano anticalcárea de latón.
- Flexo satinado.

30725305	1.410,00
30725305NM	2.172,00
30725305AC	2.172,00
30725305KMB	2.172,00
30725305OR	3.083,00
30725305OM	3.083,00
30725305OP	3.083,00
30725305OPM	3.083,00



Kit de grifo termostático empotrado de 3 vías B-system para ducha

- Cuerpo empotrado termostático de instalación horizontal incluido.
- Regulador de caudal y distribuidor de 3 vías.
- Volante cuadrado-redondo.
- Rociador de ducha empotrado a techo de acero inoxidable con 2 tipos de chorro (lluvia/free flow). 405x405 mm.
- Soporte para ducha de mano con toma de agua a pared.
- Ducha de mano anticalcárea: 96x110 mm. (3 tipos de chorro).
- Flexo satinado.

30725306	1.477,00
30725306NM	2.290,00
30725306AC	2.290,00
30725306KMB	2.290,00
30725306OR	3.250,00
30725306OM	3.250,00
30725306OP	3.250,00
30725306OPM	3.250,00

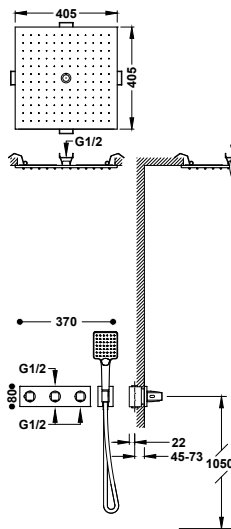

KITS DE 4 VÍAS

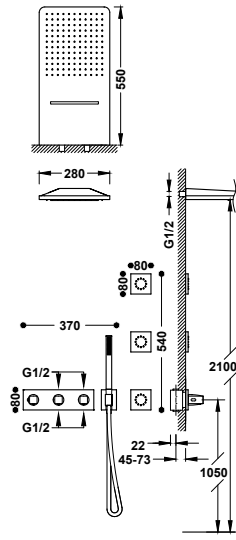

Kit de grifo termostático empotrado de 4 vías B-system para ducha

- Cuerpo empotrado termostático de instalación horizontal incluido.
- Regulador de caudal y distribuidor de 4 vías.
- Volante cuadrado-redondo.
- Rociador de ducha a pared de acero inoxidable con 2 tipos de chorro (lluvia/cascada). 280x550 mm. **IMPORTANTE:** Montar un desagüe de >50 l/min.
- 3 jets empotrados de hidromasaje.
- Soporte para ducha de mano con toma de agua a pared.
- Ducha de mano anticalcárea de latón.
- Flexo satinado.

30725405	1.842,00
30725405NM	2.854,00
30725405AC	2.854,00
30725405KMB	2.854,00 N
30725405OR	4.051,00
30725405OM	4.051,00
30725405OP	4.051,00
30725405OPM	4.051,00

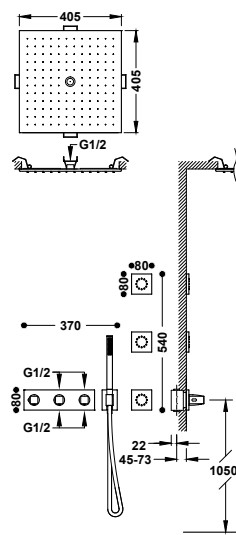

Kit de grifo termostático empotrado de 4 vías B-system para ducha

- Cuerpo empotrado termostático de instalación horizontal incluido.
- Regulador de caudal y distribuidor de 4 vías.
- Volante cuadrado-redondo.
- Rociador de ducha empotrado a techo de acero inoxidable con 2 tipos de chorro (lluvia/free flow). 405x405 mm.
- 3 jets empotrados de hidromasaje.
- Soporte para ducha de mano con toma de agua a pared.
- Ducha de mano anticalcárea de latón.
- Flexo satinado.

30725406	1.918,00
30725406NM	2.972,00
30725406AC	2.972,00
30725406KMB	2.972,00 N
30725406OR	4.219,00
30725406OM	4.219,00
30725406OP	4.219,00
30725406OPM	4.219,00





THERM-BOX

Therm-box es el sistema empotrado de Tres para los grifos termostáticos de ducha. Control total de la temperatura con un diseño compacto. Se puede adquirir la caja empotrada y la parte vista por separado; de esta manera, la planificación de la obra se simplifica y se gana en eficacia.

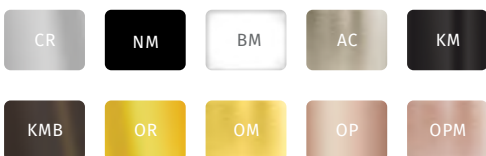

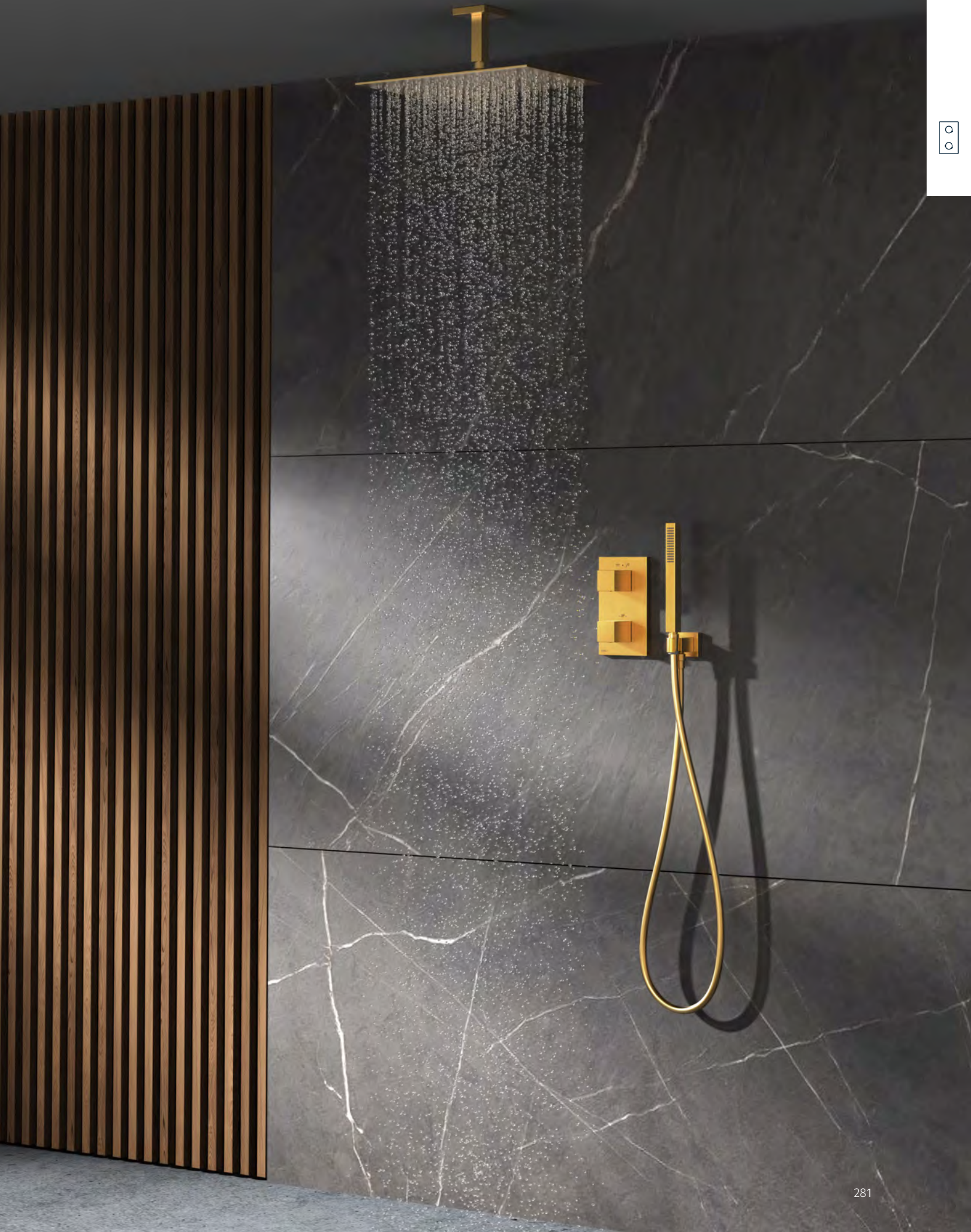



THERM-BOX

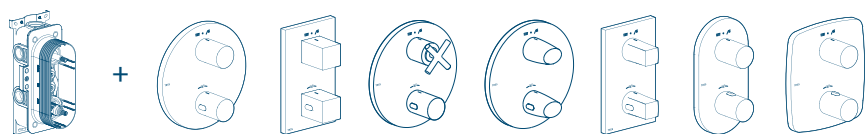

Compra por separado

Puedes instalar la caja Therm-box y, posteriormente, adquirir la parte vista para instalarla cuando esté todo listo. De esta manera, la planificación de la obra se simplifica y se gana en eficacia.

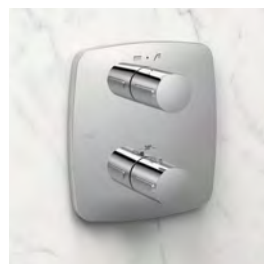

Las piezas vistas tienen **poca profundidad**, permitiendo ganar más espacio útil dentro de la ducha.



La caja empotrada Therm-box **permite instalarse por delante o por detrás de la pared**, tanto en paredes de obra como paredes ligeras de cartón y yeso (tipo Pladur).

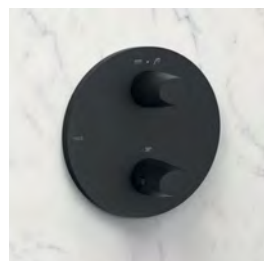

Las piezas vistas están disponibles en **varios acabados** y distintos diseños que combinan con las colecciones de Tres.



Solo se necesita un **mínimo de 66 mm de profundidad** para la instalación de la caja empotrada.



Control de temperatura con **botón de seguridad** que restringe la temperatura a 38°C.



La caja aísla la transmisión de temperatura del cuerpo de latón hacia la pared. Asimismo, al ser **estanca**, evita que en caso de fuga el agua se filtre por la pared. La junta impermeable **evita las humedades**.

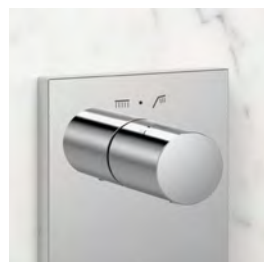

Con un sencillo giro del distribuidor se puede cambiar entre las **2 salidas de agua disponibles**.



Los **amortiguadores** evitan la transmisión del ruido del grifo a la pared y a las tuberías.

CAJA EMPOTRADA

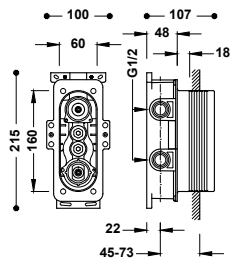

Caja empotrada de 2 vías Therm-box con grifo termostático para ducha y bañera

20785001

130,00

Cuerpo empotrado con amortiguadores acústicos. Caja de empotrar de ABS. Junta antihumedad. Distribuidor cerámico de 2 vías.



PIEZAS VISTAS DE 2 VÍAS

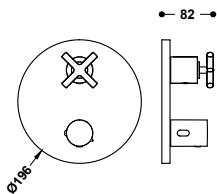

Pieza vista para caja empotrada de 2 vías Therm-box

Sólo parte vista. Volante en cruz. Incluye placa embellecedora, mando y volante distribuidor. Completar con la caja empotrada Therm-box ref.: 20785001.

28325001	179,00
28325001NM	277,00
28325001AC	277,00
28325001OM	393,00
28325001OPM	393,00

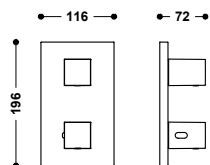

Pieza vista para caja empotrada de 2 vías Therm-box

Sólo parte vista. Volante cuadrado. Incluye placa embellecedora, mando y volante distribuidor. Completar con la caja empotrada Therm-box ref.: 20785001.

00625001	137,00
00625001NM	212,00
00625001BM	212,00
00625001AC	212,00
00625001OR	300,00
00625001OM	300,00

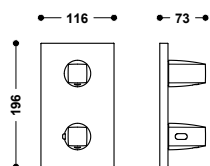

Pieza vista para caja empotrada de 2 vías Therm-box

Sólo parte vista. Volante cuadrado-redondo. Incluye placa embellecedora, mando y volante distribuidor. Completar con la caja empotrada Therm-box ref.: 20785001.

21125001	116,00
21125001NM	179,00
21125001BM	179,00
21125001AC	179,00
21125001KM	179,00
21125001KMB	179,00
21125001OR	254,00
21125001OM	254,00
21125001OP	254,00
21125001OPM	254,00

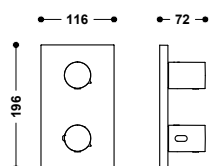

Pieza vista para caja empotrada de 2 vías Therm-box

Sólo parte vista. Volante redondo. Incluye placa embellecedora, mando y volante distribuidor. Completar con la caja empotrada Therm-box ref.: 20785001.

06225001	116,00
----------	--------

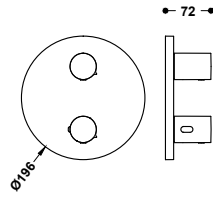

Pieza vista para caja empotrada de 2 vías Therm-box

Sólo parte vista. Volante redondo. Incluye placa embellecedora, mando y volante distribuidor. Completar con la caja empotrada Therm-box ref.: 20785001.

26225001	137,00
26225001NM	212,00
26225001BM	212,00
26225001AC	212,00
26225001KM	212,00
26225001KMB	212,00
26225001OR	300,00
26225001OM	300,00
26225001OP	300,00
26225001OPM	300,00

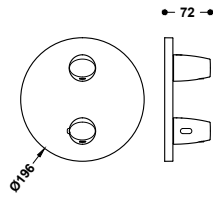

Pieza vista para caja empotrada de 2 vías Therm-box

Sólo parte vista. Volante ovalado. Incluye placa embellecedora, mando y volante distribuidor. Completar con la caja empotrada Therm-box ref.: 20785001.

28125001	116,00
28125001NM	179,00
28125001AC	179,00
28125001OPM	254,00

KITS TERMOSTÁTICOS DE 2 VÍAS

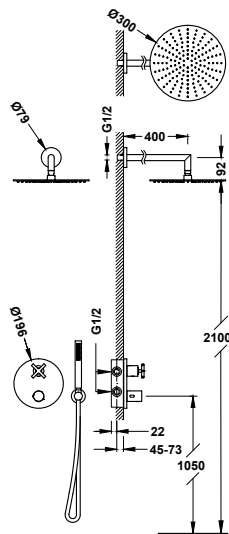

Kit de grifo termostático empotrado de 2 vías Therm-box para ducha

- Cuerpo empotrado incluido.
- Volante en cruz con control de temperatura. Distribuidor cerámico de 2 vías.
- Brazo a pared con rociador de ducha orientable y de acero inoxidable: Ø 300 mm.
- Soporte para ducha de mano con toma de agua a pared.
- Ducha de mano anticalcárea de latón.
- Flexo satinado.

28325002	625,00
28325002NM	899,00
28325002AC	899,00
28325002OM	1.224,00
28325002OPM	1.224,00



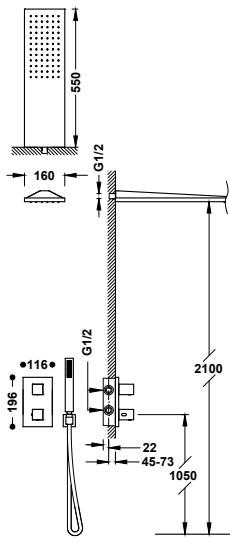

**Kit de grifo termostático empotrado de 2 vías
Therm-box para ducha**

- Cuerpo empotrado incluido.
- Volante cuadrado con control de temperatura. Distribuidor cerámico de 2 vías.
- Rociador de ducha a pared de acero inoxidable: 160x550 mm.
- Soporte para ducha de mano con toma de agua a pared.
- Ducha de mano anticalcárea de latón.
- Flexo satinado.

20225055	829,00
20225055NM	1.216,00
20225055BM	1.216,00
20225055AC	1.216,00
20225055KMB	1.216,00
20225055OR	1.672,00
20225055OM	1.672,00

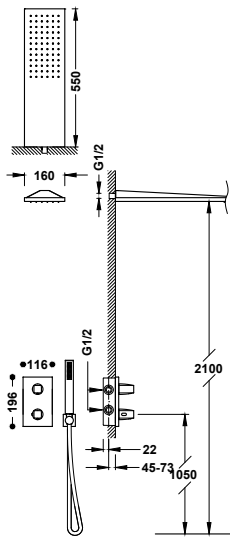

**Kit de grifo termostático empotrado de 2 vías
Therm-box para ducha**

- Cuerpo empotrado incluido.
- Volante cuadrado-redondo con control de temperatura. Distribuidor cerámico de 2 vías.
- Rociador de ducha a pared de acero inoxidable: 160x550 mm.
- Soporte para ducha de mano con toma de agua a pared.
- Ducha de mano anticalcárea de latón.
- Flexo satinado.

21125005	785,00
21125005NM	1.147,00
21125005BM	1.147,00
21125005AC	1.147,00
21125005KM	1.147,00
21125005KMB	1.147,00
21125005OR	1.575,00
21125005OM	1.575,00
21125005OP	1.575,00
21125005OPM	1.575,00

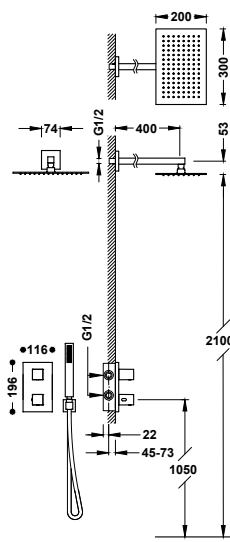

**Kit de grifo termostático empotrado de 2 vías
Therm-box para ducha**

- Cuerpo empotrado incluido.
- Volante cuadrado con control de temperatura. Distribuidor cerámico de 2 vías.
- Brazo a pared con rociador de ducha orientable y de acero inoxidable: 300x200 mm.
- Soporte para ducha de mano con toma de agua a pared.
- Ducha de mano anticalcárea de latón.
- Flexo satinado.

20225054	677,00
20225054NM	975,00
20225054BM	975,00
20225054AC	975,00
20225054OR	1.331,00
20225054OM	1.331,00



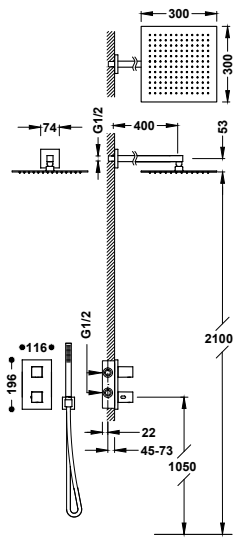

**Kit de grifo termostático empotrado de 2 vías
Therm-box para ducha**

- Cuerpo empotrado incluido.
- Volante cuadrado con control de temperatura. Distribuidor cerámico de 2 vías.
- Brazo a pared con rociador de ducha orientable y de acero inoxidable: 300x300 mm.
- Soporte para ducha de mano con toma de agua a pared.
- Ducha de mano anticalcárea de latón.
- Flexo satinado.

00625004	641,00
00625004NM	922,00
00625004BM	922,00
00625004AC	922,00
00625004OR	1.256,00
00625004OM	1.256,00

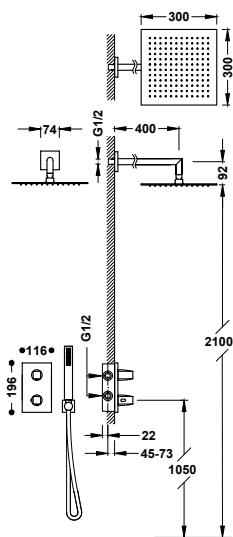

**Kit de grifo termostático empotrado de 2 vías
Therm-box para ducha**

- Cuerpo empotrado incluido.
- Volante cuadrado-redondo con control de temperatura. Distribuidor cerámico de 2 vías.
- Brazo a pared con rociador de ducha orientable y de acero inoxidable: 300x300 mm.
- Soporte para ducha de mano con toma de agua a pared.
- Ducha de mano anticalcárea de latón.
- Flexo satinado.

21125004	595,00
21125004NM	849,00
21125004BM	849,00
21125004AC	849,00
21125004KM	849,00
21125004KMB	849,00
21125004OR	1.153,00
21125004OM	1.153,00
21125004OP	1.153,00
21125004OPM	1.153,00

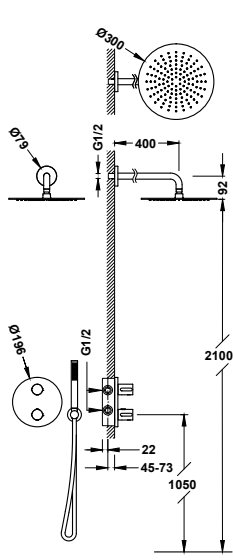

**Kit de grifo termostático empotrado de 2 vías
Therm-box para ducha**

- Cuerpo empotrado incluido.
- Volante redondo con control de temperatura. Distribuidor cerámico de 2 vías.
- Brazo a pared con rociador de ducha orientable y de acero inoxidable: Ø 300 mm.
- Soporte para ducha de mano con toma de agua a pared.
- Ducha de mano anticalcárea de latón.
- Flexo satinado.

26225004	585,00
26225004NM	837,00
26225004BM	837,00
26225004AC	837,00
26225004KM	837,00
26225004KMB	837,00
26225004OR	1.136,00
26225004OM	1.136,00
26225004OP	1.136,00
26225004OPM	1.136,00



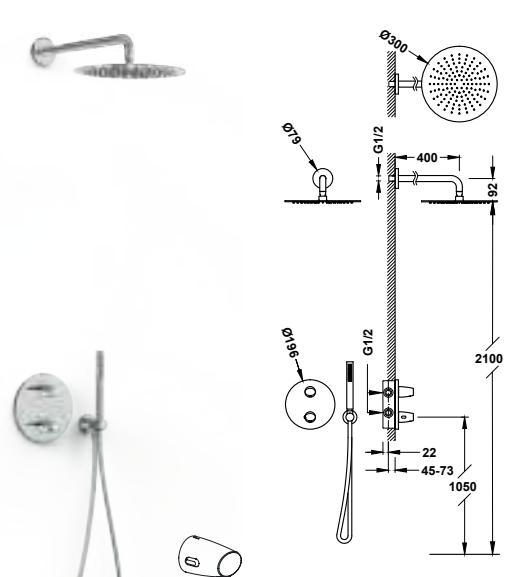

**Kit de grifo termostático empotrado de 2 vías
Therm-box para ducha**

- Cuerpo empotrado incluido.
- Volante ovalado con control de temperatura. Distribuidor cerámico de 2 vías.
- Brazo a pared con rociador de ducha orientable y de acero inoxidable: Ø 300 mm.
- Soporte para ducha de mano con toma de agua a pared.
- Ducha de mano anticalcárea de latón.
- Flexo satinado.

■ 28125004	566,00
■ 28125004NM	806,00
■ 28125004AC	806,00
■ 28125004OPM	1.092,00

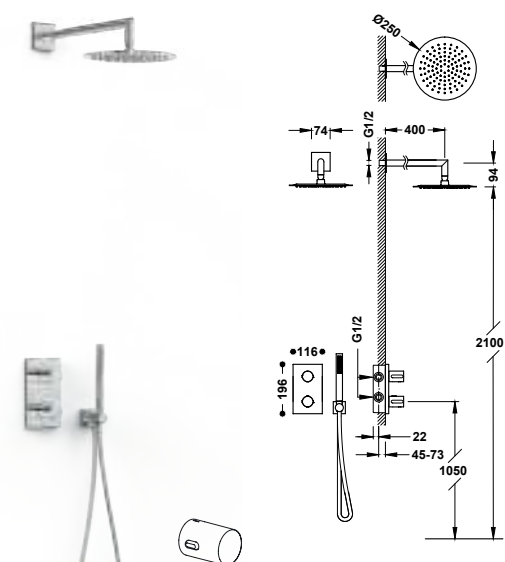

**Kit de grifo termostático empotrado de 2 vías
Therm-box para ducha**

- Cuerpo empotrado incluido.
- Volante redondo con control de temperatura. Distribuidor cerámico de 2 vías.
- Brazo a pared con rociador de ducha orientable y de acero inoxidable: Ø 250 mm.
- Soporte para ducha de mano con toma de agua a pared.
- Ducha de mano anticalcárea de latón.
- Flexo satinado.

■ 06225004	515,00
------------	--------

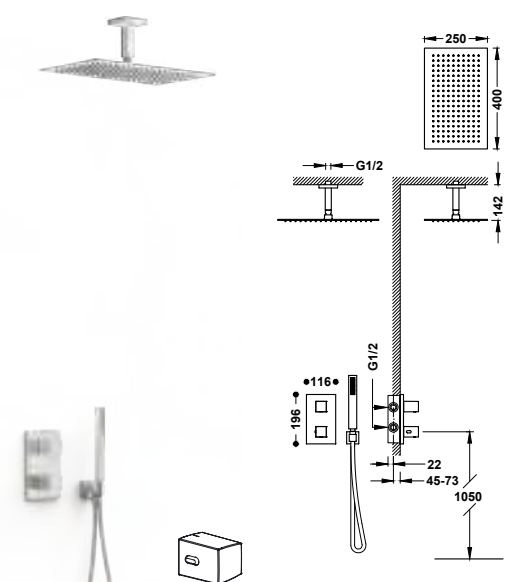

**Kit de grifo termostático empotrado de 2 vías
Therm-box para ducha**

- Cuerpo empotrado incluido.
- Volante cuadrado con control de temperatura. Distribuidor cerámico de 2 vías.
- Brazo a techo con rociador de ducha orientable y de acero inoxidable: 400x250 mm.
- Soporte para ducha de mano con toma de agua a pared.
- Ducha de mano anticalcárea de latón.
- Flexo satinado.

■ 20225053	705,00
■ 20225053NM	1.023,00
■ 20225053BM	1.023,00
■ 20225053AC	1.023,00
■ 20225053KMB	1.023,00
■ 20225053OR	1.399,00
■ 20225053OM	1.399,00



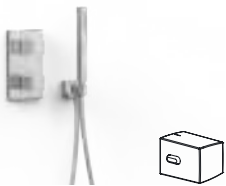
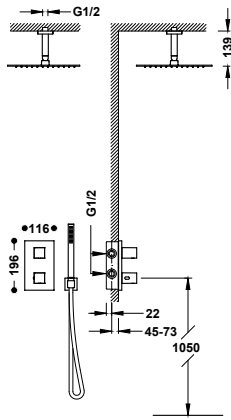
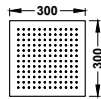

**Kit de grifo termostático empotrado de 2 vías
Therm-box para ducha**

- Cuerpo empotrado incluido.
- Volante cuadrado con control de temperatura. Distribuidor cerámico de 2 vías.
- Brazo a techo con rociador de ducha orientable y de acero inoxidable: 300x300 mm.
- Soporte para ducha de mano con toma de agua a pared.
- Ducha de mano anticalcárea de latón.
- Flexo satinado.

00625003	620,00
00625003NM	888,00
00625003BM	888,00
00625003AC	888,00
00625003OR	1.207,00
00625003OM	1.207,00

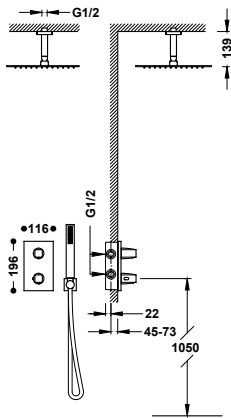
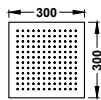

**Kit de grifo termostático empotrado de 2 vías
Therm-box para ducha**

- Cuerpo empotrado incluido.
- Volante cuadrado-redondo con control de temperatura. Distribuidor cerámico de 2 vías.
- Brazo a techo con rociador de ducha orientable y de acero inoxidable: 300x300 mm.
- Soporte para ducha de mano con toma de agua a pared.
- Ducha de mano anticalcárea de latón.
- Flexo satinado.

21125003	566,00
21125003NM	805,00
21125003BM	805,00
21125003AC	805,00
21125003KM	805,00
21125003KMB	805,00
21125003OR	1.089,00
21125003OM	1.089,00
21125003OP	1.089,00
21125003OPM	1.089,00

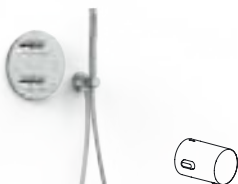
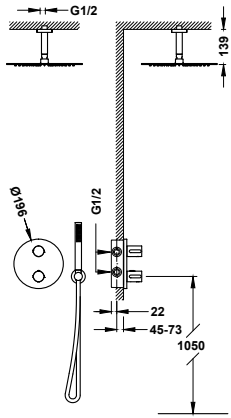
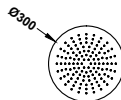

**Kit de grifo termostático empotrado de 2 vías
Therm-box para ducha**

- Cuerpo empotrado incluido.
- Volante redondo con control de temperatura. Distribuidor cerámico de 2 vías.
- Brazo a techo con rociador de ducha orientable y de acero inoxidable: Ø 300 mm.
- Soporte para ducha de mano con toma de agua a pared.
- Ducha de mano anticalcárea de latón.
- Flexo satinado.

26225003	558,00
26225003NM	797,00
26225003BM	797,00
26225003AC	797,00
26225003KM	797,00
26225003KMB	797,00
26225003OR	1.078,00
26225003OM	1.078,00
26225003OP	1.078,00
26225003OPM	1.078,00





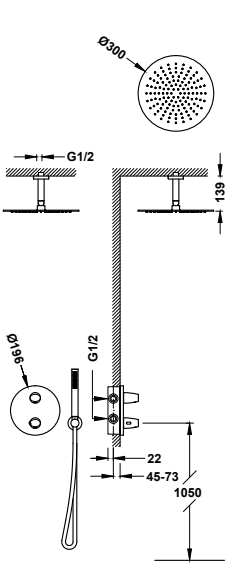



Kit de grifo termostático empotrado de 2 vías Therm-box para ducha

- Cuerpo empotrado incluido.
- Volante ovalado con control de temperatura. Distribuidor cerámico de 2 vías.
- Brazo a techo con rociador de ducha orientable y de acero inoxidable: Ø 300 mm.
- Soporte para ducha de mano con toma de agua a pared.
- Ducha de mano anticalcárea de latón.
- Flexo satinado.

	28125003	538,00
	28125003NM	766,00
	28125003AC	766,00





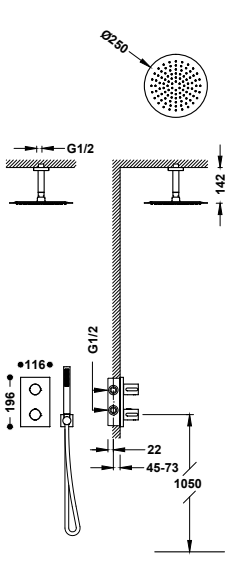



Kit de grifo termostático empotrado de 2 vías Therm-box para ducha

- Cuerpo empotrado incluido.
- Volante redondo con control de temperatura. Distribuidor cerámico de 2 vías.
- Brazo a techo con rociador de ducha orientable y de acero inoxidable: Ø 250 mm.
- Soporte para ducha de mano con toma de agua a pared.
- Ducha de mano anticalcárea de latón.
- Flexo satinado.

	06225003	480,00
--	----------	--------





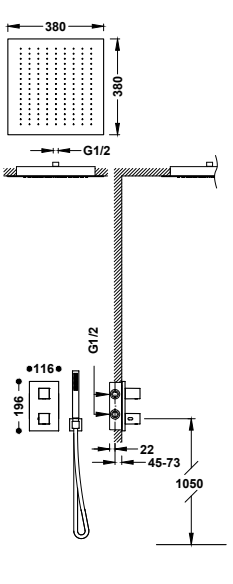

Kit de grifo termostático empotrado de 2 vías Therm-box para ducha

- Cuerpo empotrado incluido.
- Volante cuadrado con control de temperatura. Distribuidor cerámico de 2 vías.
- Rociador de ducha empotrado a techo de acero inoxidable: 380x380 mm.
- Soporte para ducha de mano con toma de agua a pared.
- Ducha de mano anticalcárea de latón.
- Flexo satinado.

	00625005	1.180,00
	00625005NM	1.761,00
	00625005BM	1.761,00
	00625005AC	1.761,00
	00625005OR	2.447,00
	00625005OM	2.447,00



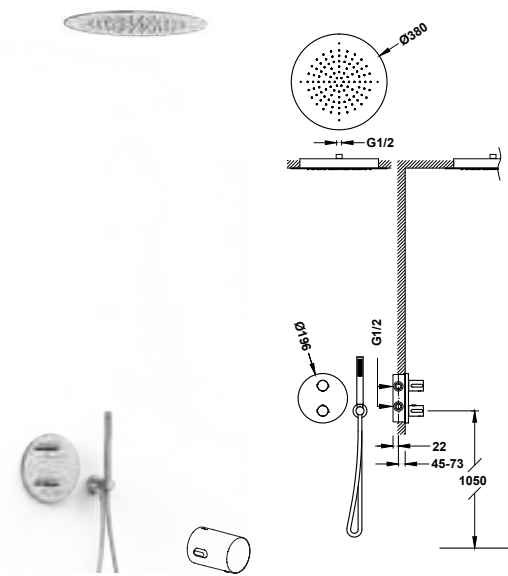

**Kit de grifo termostático empotrado de 2 vías
Therm-box para ducha**

- Cuerpo empotrado incluido.
- Volante redondo con control de temperatura. Distribuidor cerámico de 2 vías.
- Rociador de ducha empotrado a techo de acero inoxidable: Ø 380 mm.
- Soporte para ducha de mano con toma de agua a pared.
- Ducha de mano anticalcárea de latón.
- Flexo satinado.

26225005	1.164,00
26225005NM	1.737,00
26225005BM	1.737,00
26225005AC	1.737,00
26225005KM	1.737,00
26225005KMB	1.737,00
26225005OR	2.412,00
26225005OM	2.412,00
26225005OP	2.412,00
26225005OPM	2.412,00

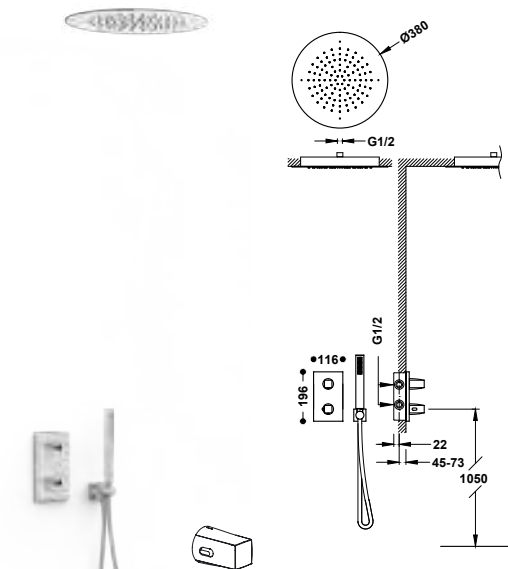

**Kit de grifo termostático empotrado de 2 vías
Therm-box para ducha**

- Cuerpo empotrado incluido.
- Volante cuadrado-redondo con control de temperatura. Distribuidor cerámico de 2 vías.
- Rociador de ducha empotrado a techo de acero inoxidable: Ø 380 mm.
- Soporte para ducha de mano con toma de agua a pared.
- Ducha de mano anticalcárea de latón.
- Flexo satinado.

21125006	1.140,00
21125006NM	1.696,00
21125006BM	1.696,00
21125006AC	1.696,00
21125006KM	1.696,00
21125006KMB	1.696,00
21125006OR	2.355,00
21125006OM	2.355,00
21125006OP	2.355,00
21125006OPM	2.355,00

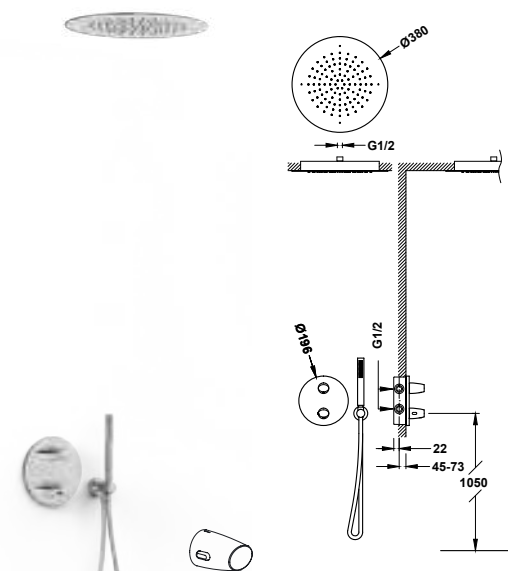

**Kit de grifo termostático empotrado de 2 vías
Therm-box para ducha**

- Cuerpo empotrado incluido.
- Volante ovalado con control de temperatura. Distribuidor cerámico de 2 vías.
- Rociador de ducha empotrado a techo de acero inoxidable: Ø 380 mm.
- Soporte para ducha de mano con toma de agua a pared.
- Ducha de mano anticalcárea de latón.
- Flexo satinado.

28125005	1.145,00
28125005NM	1.706,00
28125005AC	1.706,00
28125005OPM	2.369,00



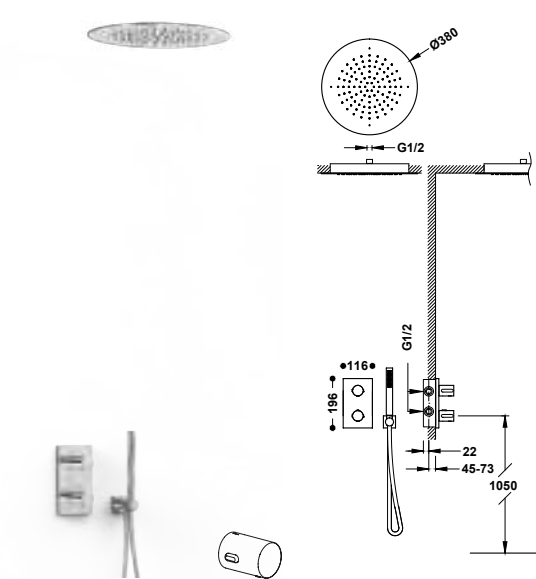

**Kit de grifo termostático empotrado de 2 vías
Therm-box para ducha**

06225005 1.131,00

- Cuerpo empotrado incluido.
- Volante redondo con control de temperatura. Distribuidor cerámico de 2 vías.
- Rociador empotrado a techo de acero inoxidable: Ø 380 mm.
- Soporte para ducha de mano con toma de agua a pared.
- Ducha de mano anticalcárea de latón.
- Flexo satinado.

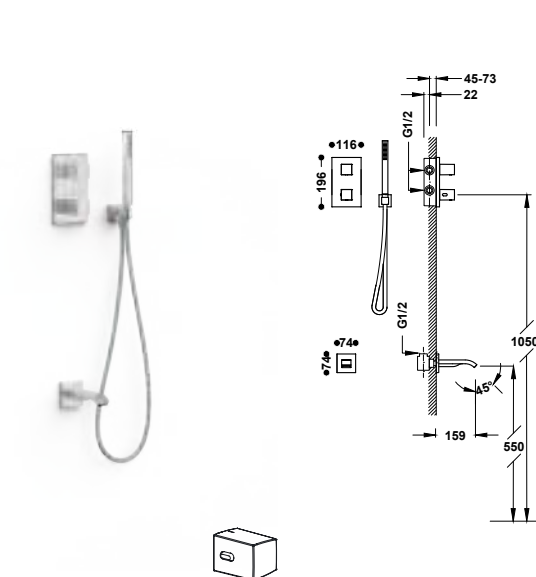

**Kit de grifo termostático empotrado de 2 vías
Therm-box para bañera y ducha**

00625006 542,00
00625006NM 769,00
00625006BM 769,00
00625006AC 769,00
00625006OR 1.039,00
00625006OM 1.039,00

- Cuerpo empotrado incluido.
- Volante cuadrado con control de temperatura. Distribuidor cerámico de 2 vías.
- Caño fijo de bañera a pared.
- Soporte para ducha de mano con toma de agua a pared.
- Ducha de mano anticalcárea de latón.
- Flexo satinado.

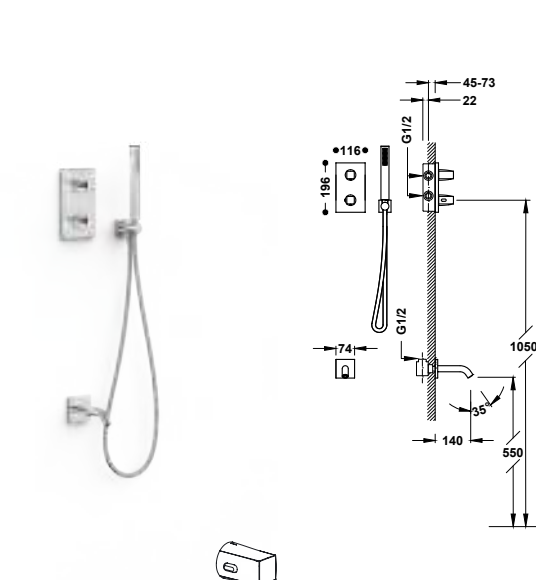

**Kit de grifo termostático empotrado de 2 vías
Therm-box para bañera y ducha**

21125007 445,00
21125007NM 621,00
21125007BM 621,00
21125007AC 621,00
21125007KM 621,00
21125007KMB 621,00
21125007OR 828,00
21125007OM 828,00
21125007OP 828,00
21125007OPM 828,00

- Cuerpo empotrado incluido.
- Volante cuadrado-redondo con control de temperatura. Distribuidor cerámico de 2 vías.
- Caño fijo de bañera a pared.
- Soporte para ducha de mano con toma de agua a pared.
- Ducha de mano anticalcárea de latón.
- Flexo satinado.



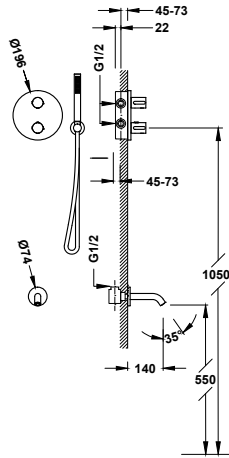

**Kit de grifo termostático empotrado de 2 vías
Therm-box para bañera y ducha**

- Cuerpo empotrado incluido.
- Volante redondo con control de temperatura. Distribuidor cerámico de 2 vías.
- Caño fijo de bañera a pared.
- Soporte para ducha de mano con toma de agua a pared.
- Ducha de mano anticalcárea de latón.
- Flexo satinado.

26225006	470,00
26225006NM	650,00
26225006BM	650,00
26225006AC	650,00
26225006KM	650,00
26225006KMB	650,00
26225006OR	850,00
26225006OM	850,00
26225006OP	850,00
26225006OPM	850,00

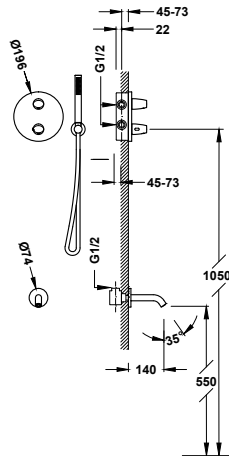

**Kit de grifo termostático empotrado de 2 vías
Therm-box para bañera y ducha**

- Cuerpo empotrado incluido.
- Volante ovalado con control de temperatura. Distribuidor cerámico de 2 vías.
- Caño fijo de bañera a pared.
- Soporte para ducha de mano con toma de agua a pared.
- Ducha de mano anticalcárea de latón.
- Flexo satinado.

28125006	450,00
28125006NM	633,00
28125006AC	633,00

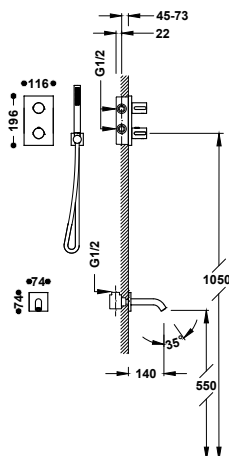

**Kit de grifo termostático empotrado de 2 vías
Therm-box para bañera y ducha**

- Cuerpo empotrado incluido.
- Volante redondo con control de temperatura. Distribuidor cerámico de 2 vías.
- Caño fijo de bañera a pared.
- Soporte para ducha de mano con toma de agua a pared.
- Ducha de mano anticalcárea de latón.
- Flexo satinado.

06225006	436,00
----------	--------



OVER-WALL

La colección de termostáticas Over-wall agrupa todos los grifos termostáticos murales de Tres. Con diseños distintos que se adaptan a todos los ambientes, consiguen un control preciso de la temperatura y todas las prestaciones para una ducha agradable. Los conjuntos termostáticos Over-wall son la solución para actualizar tu ducha sin grandes reformas y con la mejor tecnología.

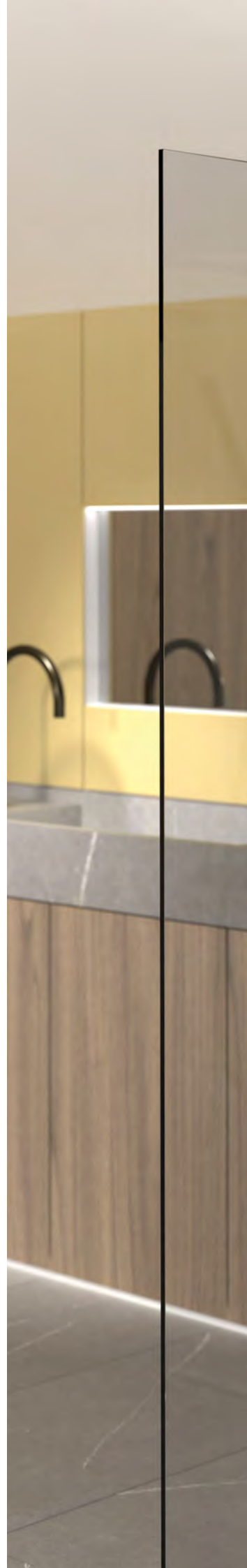





OVER-WALL



Cuadrado



Cuadrado-redondo



Redondo



Bordes redondeados



Ovalado



Control de temperatura con **botón de seguridad** que restringe la temperatura a 38°C.



Touch-cool

El circuito interno del agua provoca que el agua fría sea la que toque con la superficie y de este modo **el grifo siempre está frío al tacto, evitando quemaduras.**



Inversor integrado en el volante regulador de caudal, tanto para 2 como para 3 vías.

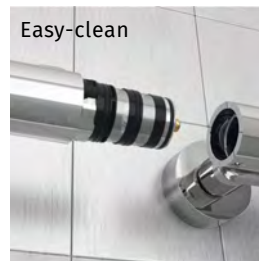

Easy-clean

Tres ofrece la posibilidad de **limpiar fácilmente el cartucho** en caso de obstrucción sin perder su calibración.





















































Barra telescópica que permite definir la altura del rociador, según cada necesidad.













































Instant 77







































El cartucho garantiza un **caudal de agua constante** a la temperatura deseada de ± 1 grado ante variaciones de presión y/o temperatura. Concebido para la desinfección de la legionela.

Referencia	Página	Acabados disponibles	Diseño volante	Touch-cool	Barra telescópica	Flexo	Rociador	Dimensiones	Caudal (l/min)	Ducha de mano	Dimensiones	Número de funciones	Caudal (l/min)
 19039306	→302							300 x 200	12			1	9.5
 19039308	→302							300 x 300	12			1	9.5
 19039310	→302							250 x 250	12			1	9.5
 19039309	→303							300 x 300	12		96 x 110	3	882
 19039305	→303							300 x 300	12			1	9.5
 19038702	→303							300 x 300	12		96 x 110	3	88 2

Referencia	Página	Acabados disponibles	Diseño volante	Touch-cool	Barra telescópica	Flexo	Rociador	Dimensiones	Caudal (l/min)	Ducha de mano	Dimensiones	Número de funciones	Caudal (l/min)
 19039307	→304							300 x 300	12			1	9.5
 19038706	→304							250 x 250	12		96 x 110	3	882
 19038705	→304							300	12		100	3	882
 19039302	→305							300	12			1	9.5
 19039311	→305							250 x 250	12		96 x 110	3	882
 19038709	→305							250 x 250	12			1	9.5



Referencia	Página	Acabados disponibles	Diseño volante	Touch-cool	Barra telescópica	Flexo	Rociador	Dimensiones	Caudal (l/min)	Ducha de mano	Dimensiones	Número de funciones	Caudal (l/min)
 19039314	→306							300	12		100	3	882
 19038708	→306							Ø 250	12			1	9.5
 19039313	→306							250 x 250	12		96 x 110	3	882
 19039312	→307							Ø 250	12			1	9.5
 19039318	→307							220 x 220	12			1	13
 19038707	→307							242 x 242	12		120 x 120	3	10149

Referencia	Página	Acabados disponibles	Diseño volante	Touch-cool	Barra telescópica	Flexo	Rociador	Dimensiones	Caudal (l/min)	Ducha de mano	Dimensiones	Número de funciones	Caudal (l/min)
 19039315	→308							Ø 225	12		Ø 110	5	1717111710
 19031215	→308							300 x 300	12			1	9.5
 19031205	→308							300 x 300	12			1	9.5
 19031212	→309							300	12			1	9.5
 19031202	→309							Ø 300	12			1	9.5



CONJUNTOS TERMOSTÁTICOS PARA DUCHA

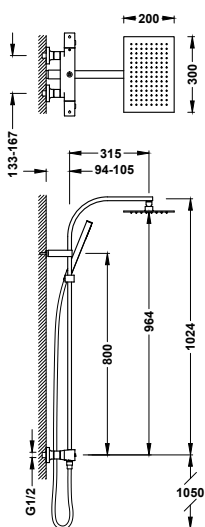

Conjunto de grifo termostático mural Over-wall de 2 vías para ducha

- Con inversor integrado en el regulador de caudal.
- Volante cuadrado.
- Rociador de ducha orientable de acero inoxidable: 300x200 mm.
- Soporte deslizante y orientable para ducha de mano.
- Ducha de mano anticalcárea de latón.
- Flexo satinado.

19039306	671,00
19039306NM	1.040,00
19039306BM	1.040,00
19039306AC	1.040,00
19039306KMB	1.040,00
19039306OM	1.476,00

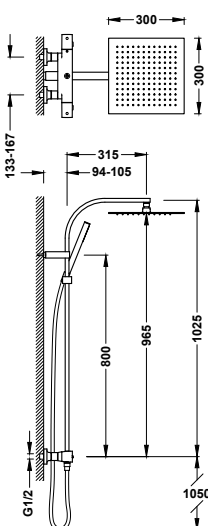

Conjunto de grifo termostático mural Over-wall de 2 vías para ducha

- Con inversor integrado en el regulador de caudal.
- Volante cuadrado.
- Rociador de ducha orientable de acero inoxidable: 300x300 mm.
- Soporte deslizante y orientable para ducha de mano.
- Ducha de mano anticalcárea de latón.
- Flexo satinado.

19039308	620,00
19039308NM	961,00
19039308BM	961,00
19039308AC	961,00
19039308OM	1.364,00

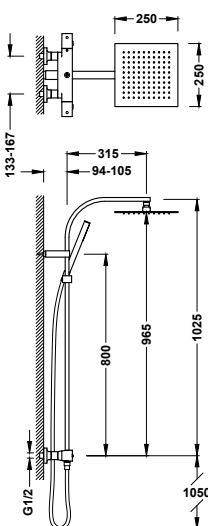

Conjunto de grifo termostático mural Over-wall de 2 vías para ducha

- Con inversor integrado en el regulador de caudal.
- Volante cuadrado.
- Rociador de ducha orientable de acero inoxidable: 250x250 mm.
- Soporte deslizante y orientable para ducha de mano.
- Ducha de mano anticalcárea de latón.
- Flexo satinado.

19039310	590,00
----------	--------



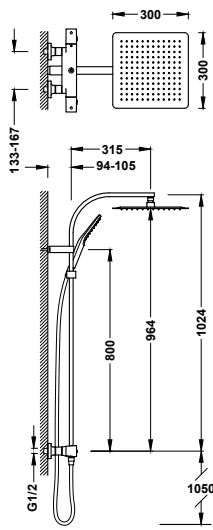

Conjunto de grifo termostático mural Over-wall de 2 vías para ducha

19039309 587,00

- Con inversor integrado en el regulador de caudal.
- Volante cuadrado.
- Rociador de ducha orientable de acero inoxidable: 300x300 mm.
- Soporte deslizante y orientable para ducha de mano.
- Ducha de mano anticalcárea: 96x110 mm. (3 tipos de chorro).
- Flexo satinado.

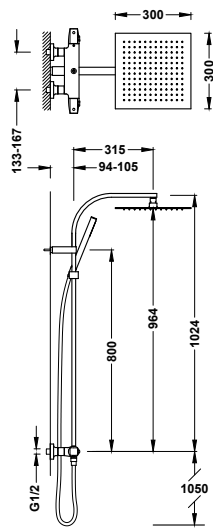

Conjunto de grifo termostático mural Over-wall de 2 vías para ducha

19039305	625,00
19039305NM	969,00
19039305BM	969,00
19039305AC	969,00
19039305KMB	969,00
19039305OM	1.375,00
19039305OPM	1.375,00

- Con inversor integrado en el regulador de caudal.
- Volante cuadrado-redondo.
- Rociador de ducha orientable de acero inoxidable: 300x300 mm.
- Soporte deslizante y orientable para ducha de mano.
- Ducha de mano anticalcárea de latón.
- Flexo satinado.

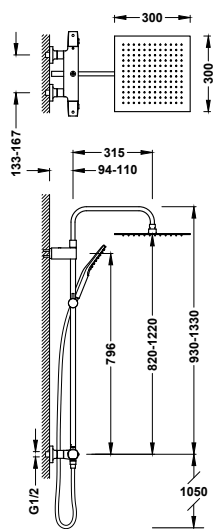

Conjunto de grifo termostático mural Over-wall de 2 vías para ducha

19038702	609,00
19038702NM	944,00
19038702BM	944,00
19038702AC	944,00
19038702KMB	944,00
19038702OM	1.340,00
19038702OPM	1.340,00

- Con inversor integrado en el regulador de caudal.
- Volante con bordes redondeados.
- Barra de ducha telescópica.
- Rociador de ducha orientable de acero inoxidable: 300x300 mm.
- Soporte deslizante y orientable para ducha de mano.
- Ducha de mano anticalcárea: 96x110 mm. (3 tipos de chorro).
- Flexo satinado.



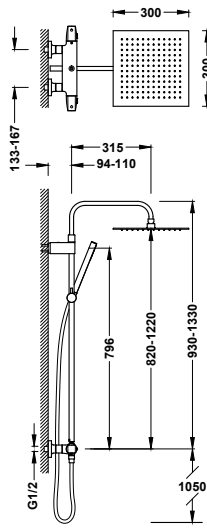

Conjunto de grifo termostático mural Over-wall de 2 vías para ducha

- Con inversor integrado en el regulador de caudal.
- Volante cuadrado-redondo.
- Barra de ducha telescópica.
- Rociador de ducha orientable de acero inoxidable: 300x300 mm.
- Soporte deslizante y orientable para ducha de mano.
- Ducha de mano anticalcárea de latón.
- Flexo satinado.

19039307	596,00
19039307NM	924,00
19039307BM	924,00
19039307AC	924,00
19039307KMB	924,00
19039307OM	1.311,00
19039307OPM	1.311,00

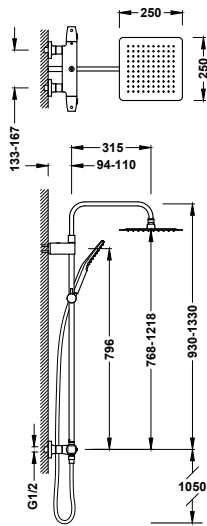

Conjunto de grifo termostático mural Over-wall de 2 vías para ducha

- Con inversor integrado en el regulador de caudal.
- Volante cuadrado-redondo.
- Barra de ducha telescópica.
- Rociador de ducha orientable de acero inoxidable: 250x250 mm.
- Soporte deslizante y orientable para ducha de mano.
- Ducha de mano anticalcárea: 96x110 mm. (3 tipos de chorro).
- Flexo satinado.

19038706	583,00
----------	--------

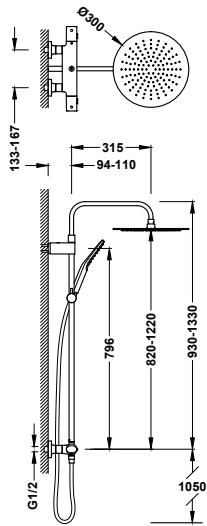
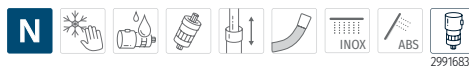

Conjunto de grifo termostático mural Over-wall de 2 vías para ducha

- Con inversor integrado en el regulador de caudal.
- Volante ovalado.
- Barra de ducha telescópica.
- Rociador de ducha orientable de acero inoxidable: Ø 300 mm.
- Soporte deslizante y orientable para ducha de mano.
- Ducha de mano anticalcárea: Ø 110 mm. (3 tipos de chorro).
- Flexo satinado.

19038705	580,00
19038705NM	899,00
19038705BM	899,00
19038705AC	899,00
19038705KMB	899,00
19038705OM	1.276,00
19038705OPM	1.276,00



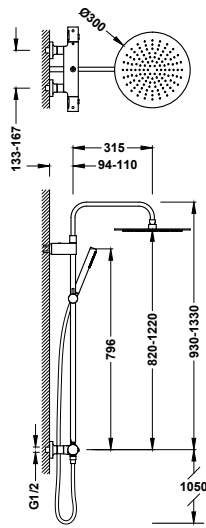

Conjunto de grifo termostático mural Over-wall de 2 vías para ducha

- Con inversor integrado en el regulador de caudal.
- Volante redondo.
- Barra de ducha telescópica.
- Rociador de ducha orientable de acero inoxidable: Ø 300 mm.
- Soporte deslizante y orientable para ducha de mano.
- Ducha de mano anticalcárea de latón.
- Flexo satinado.

19039302	559,00
19039302NM	866,00
19039302BM	866,00
19039302AC	866,00
19039302KMB	866,00
19039302OM	1.230,00
19039302OPM	1.230,00



29916832XX

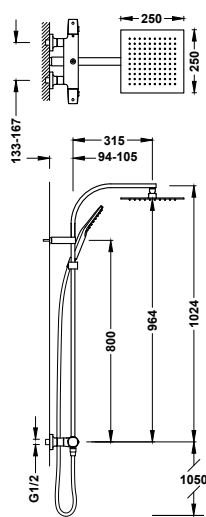

Conjunto de grifo termostático mural Over-wall de 2 vías para ducha

- Con inversor integrado en el regulador de caudal.
- Volante con bordes redondeados.
- Rociador de ducha orientable de acero inoxidable: 250x250 mm.
- Soporte deslizante y orientable para ducha de mano.
- Ducha de mano anticalcárea: 96x110 mm. (3 tipos de chorro).
- Flexo satinado.

19039311	550,00
----------	--------



29916834

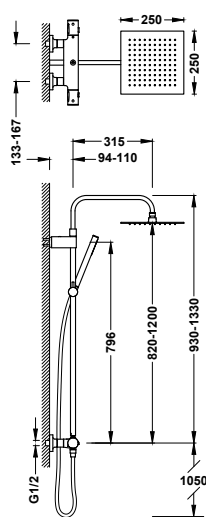

Conjunto de grifo termostático mural Over-wall de 2 vías para ducha

- Con inversor integrado en el regulador de caudal.
- Barra de ducha telescópica.
- Volante redondo.
- Rociador de ducha orientable de acero inoxidable: 250x250 mm.
- Soporte deslizante y orientable para ducha de mano.
- Ducha de mano anticalcárea de latón.
- Flexo satinado.

19038709	539,00
----------	--------



29916832

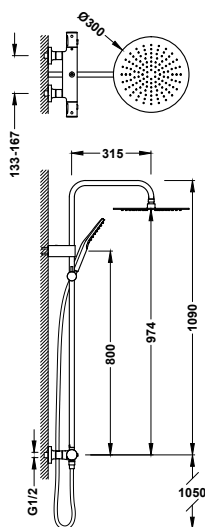

Conjunto de grifo termostático mural Over-wall de 2 vías para ducha

- Con inversor integrado en el regulador de caudal.
- Volante redondo.
- Rociador de ducha orientable de acero inoxidable: Ø300 mm.
- Soporte deslizante y orientable para ducha de mano.
- Ducha de mano anticalcárea: Ø110 mm. (3 tipos de chorro).
- Flexo satinado.

19039314	503,00
19039314NM	780,00
19039314BM	780,00
19039314AC	780,00
19039314KMB	780,00
19039314OM	1.106,00
19039314OPM	1.106,00

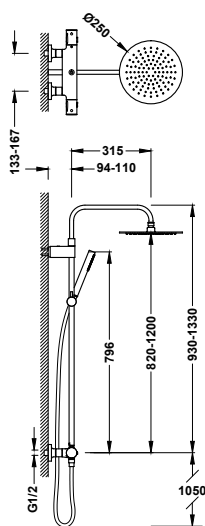

Conjunto de grifo termostático mural Over-wall de 2 vías para ducha

- Con inversor integrado en el regulador de caudal.
- Barra de ducha telescópica.
- Volante redondo.
- Rociador de ducha orientable de acero inoxidable: Ø250 mm.
- Soporte deslizante y orientable para ducha de mano.
- Ducha de mano anticalcárea de latón.
- Flexo satinado.

19038708	489,00
----------	--------

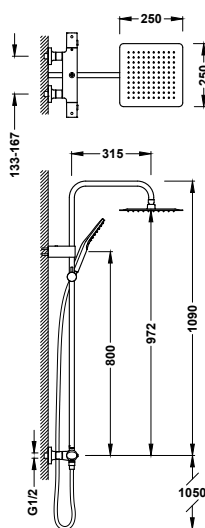
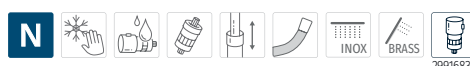

Conjunto de grifo termostático mural Over-wall de 2 vías para ducha

- Con inversor integrado en el regulador de caudal.
- Volante ovalado.
- Rociador de ducha orientable de acero inoxidable: 250x250 mm.
- Soporte deslizante y orientable para ducha de mano.
- Ducha de mano anticalcárea: 96x110 mm. (3 tipos de chorro).
- Flexo satinado.

19039313	486,00
----------	--------



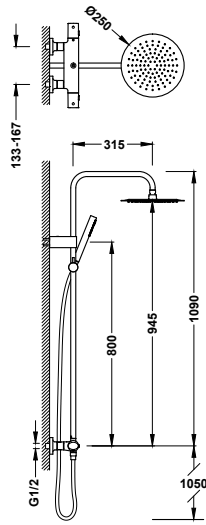

Conjunto de grifo termostático mural Over-wall de 2 vías para ducha

19039312

465,00

- Con inversor integrado en el regulador de caudal.
- Volante ovalado.
- Rociador de ducha orientable de acero inoxidable: Ø250 mm.
- Soporte deslizante y orientable para ducha de mano.
- Ducha de mano anticalcárea de latón.
- Flexo satinado.

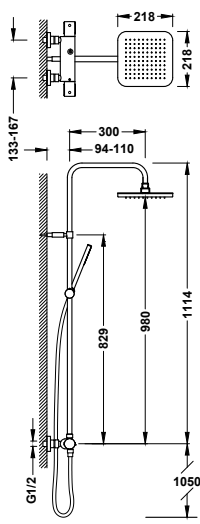

Conjunto de grifo termostático mural Over-wall de 2 vías para ducha

19039318

443,00

- Con inversor integrado en el regulador de caudal.
- Volante redondo de ABS.
- Rociador de ducha orientable: 218x218 mm.
- Soporte deslizante y orientable para ducha de mano.
- Ducha de mano anticalcárea.
- Flexo metálico.

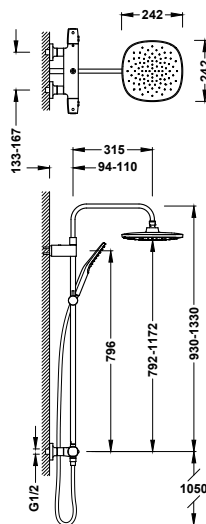

Conjunto de grifo termostático mural Over-wall de 2 vías para ducha

19038707

435,00

- Con inversor integrado en el regulador de caudal.
- Barra de ducha telescópica.
- Volante con bordes redondeados.
- Rociador de ducha orientable: 242x242 mm.
- Soporte deslizante y orientable para ducha de mano.
- Ducha de mano anticalcárea: 120x120 mm. (3 tipos de chorro).
- Flexo satinado.

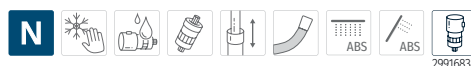

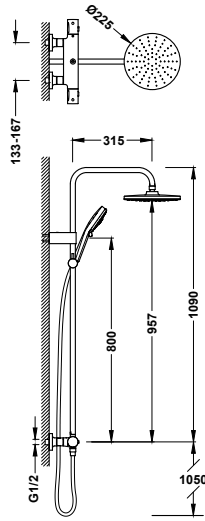

Conjunto de grifo termostático mural Over-wall de 3 vías para bañera y ducha

19039315 398,00

- Con inversor integrado en el regulador de caudal.
- Volante redondo.
- Barra de ducha telescópica.
- Rociador de ducha orientable de acero inoxidable: Ø 300 mm.
- Soporte deslizante y orientable para ducha de mano.
- Ducha de mano anticalcárea de latón.
- Flexo satinado.



CONJUNTOS TERMOSTÁTICOS PARA BAÑERA

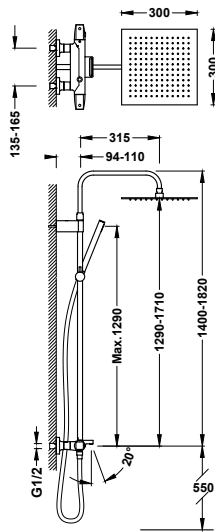

Conjunto de grifo termostático mural Over-wall de 3 vías para bañera y ducha

19031215 685,00
 19031215NM 1.062,00
 19031215BM 1.062,00
 19031215AC 1.062,00
 19031215KMB 1.062,00
 19031215OM 1.507,00
 19031215OPM 1.507,00

- Con inversor integrado en el regulador de caudal.
- Volante cuadrado-redondo.
- Barra de ducha telescópica.
- Rociador de ducha orientable de acero inoxidable: 300x300 mm.
- Soporte deslizante y orientable para ducha de mano.
- Ducha de mano anticalcárea de latón.
- Flexo satinado.

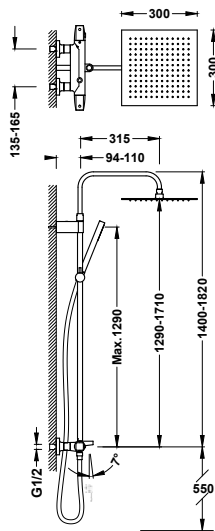
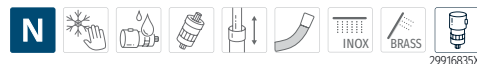

Conjunto de grifo termostático mural Over-wall de 3 vías para bañera y ducha

19031205 643,00
 19031205NM 997,00
 19031205BM 997,00
 19031205AC 997,00
 19031205KMB 997,00
 19031205OM 1.415,00
 19031205OPM 1.415,00

- Con inversor integrado en el regulador de caudal.
- Volante cuadrado-redondo.
- Barra de ducha telescópica.
- Rociador de ducha orientable de acero inoxidable: 300x300 mm.
- Soporte deslizante y orientable para ducha de mano.
- Ducha de mano anticalcárea de latón.
- Flexo satinado.



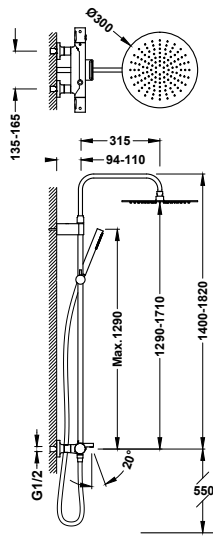

Conjunto de grifo termostático mural Over-wall de 3 vías para bañera y ducha

- Con inversor integrado en el regulador de caudal.
- Volante redondo.
- Barra de ducha telescópica.
- Rociador de ducha orientable de acero inoxidable: Ø 300 mm.
- Soporte deslizante y orientable para ducha de mano.
- Ducha de mano anticalcárea de latón.
- Flexo satinado.

19031212	654,00
19031212NM	1.014,00
19031212BM	1.014,00
19031212AC	1.014,00
19031212KMB	1.014,00
19031212OM	1.439,00
19031212OPM	1.439,00

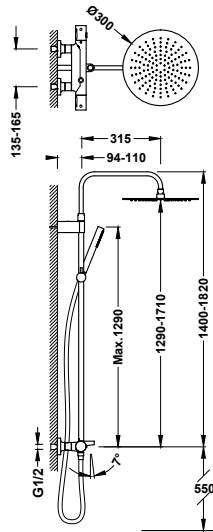

Conjunto de grifo termostático mural Over-wall de 3 vías para bañera y ducha

- Con inversor integrado en el regulador de caudal.
- Volante redondo.
- Barra de ducha telescópica.
- Rociador de ducha orientable de acero inoxidable: Ø 300 mm.
- Soporte deslizante y orientable para ducha de mano.
- Ducha de mano anticalcárea de latón.
- Flexo satinado.

19031202	612,00
19031202NM	949,00
19031202BM	949,00
19031202AC	949,00
19031202KMB	949,00
19031202OM	1.346,00
19031202OPM	1.346,00



GRIFOS TERMOSTÁTICOS PARA DUCHA

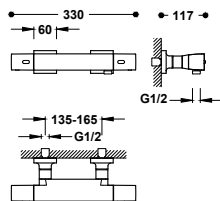

Grifo termostático mural Over-wall para ducha

Ducha de mano anticalcárea de latón. Soporte orientable para ducha de mano. Flexo satinado. Volante cuadrado.

- 19016469 278,00
- 19016469NM 431,00
- 19016469BM 431,00
- 19016469AC 431,00
- 19016469OM 612,00



29916836XX

Grifo termostático sin complementos

- 19016406 231,00

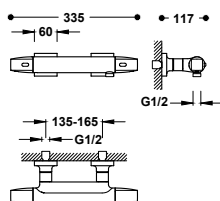

Grifo termostático mural Over-wall para ducha

Ducha de mano anticalcárea de latón. Soporte orientable para ducha de mano. Flexo satinado. Volante cuadrado-redondo.

- 19016459 236,00
- 19016459NM 366,00
- 19016459BM 366,00
- 19016459AC 366,00
- 19016459KMB 366,00
- 19016459OM 520,00
- 19016459OPM 520,00

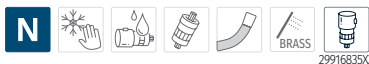

29916835XX

Grifo termostático sin complementos

- 19016405 189,00

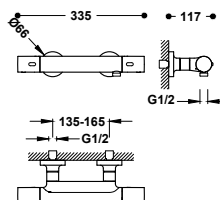

Grifo termostático mural Over-wall para ducha

Ducha de mano anticalcárea de latón. Soporte orientable para ducha de mano. Flexo satinado. Volante redondo.

- 19016429 236,00
- 19016429NM 366,00
- 19016429BM 366,00
- 19016429AC 366,00
- 19016429KMB 366,00
- 19016429OM 520,00
- 19016429OPM 520,00



29916832XX

Grifo termostático sin complementos

- 19016402 189,00



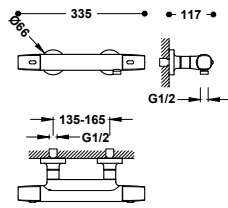

Grifo termostático mural Over-wall para ducha

Ducha de mano anticalcárea de latón. Soporte orientable para ducha de mano. Flexo satinado. Volante con bordes redondeados.

19016449	236,00
19016449NM	366,00
19016449BM	366,00
19016449AC	366,00
19016449KMB	366,00
19016449OM	520,00
19016449OPM	520,00



Grifo termostático sin complementos

19016404	189,00
----------	--------

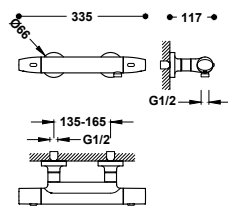

Grifo termostático mural Over-wall para ducha

Ducha de mano anticalcárea de latón. Soporte orientable para ducha de mano. Flexo satinado. Volante ovalado.

19016439	236,00
19016439NM	366,00
19016439BM	366,00
19016439AC	366,00
19016439KMB	366,00
19016439OM	520,00
19016439OPM	520,00



Grifo termostático sin complementos

19016403	189,00
----------	--------

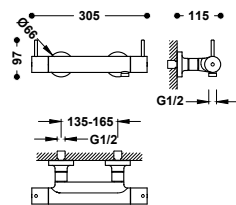

Grifo termostático mural para ducha con palancas ergonómicas

Sin complementos. Indicado para personas con discapacidades físicas.

19026410	235,00
----------	--------



GRIFOS TERMOSTÁTICOS PARA BAÑERA

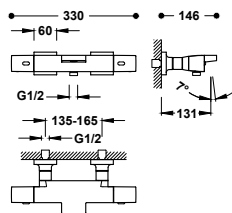

Grifo termostático mural Over-wall para bañera y ducha

Ducha de mano anticalcárea de latón. Soporte orientable para ducha de mano. Flexo satinado. Volante cuadrado.

- 19017469 373,00
- 19017469NM 550,00
- 19017469BM 550,00
- 19017469AC 550,00
- 19017469OM 710,00

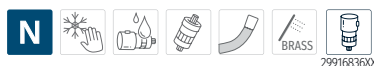

Grifo termostático sin complementos



- 19017406 326,00

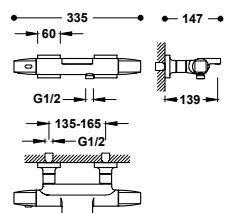

Grifo termostático mural Over-wall para bañera y ducha

Ducha de mano anticalcárea de latón. Soporte orientable para ducha de mano. Flexo satinado. Volante cuadrado-redondo.

- 19017489 388,00
- 19017489NM 601,00
- 19017489BM 601,00
- 19017489AC 601,00
- 19017489KMB 601,00
- 19017489OM 854,00
- 19017489OPM 854,00

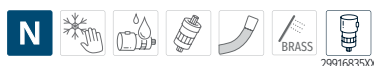

Grifo termostático sin complementos



- 19017415 341,00

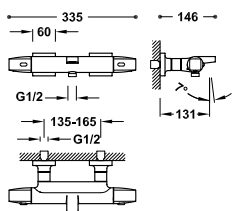

Grifo termostático mural Over-wall para bañera y ducha

Ducha de mano anticalcárea de latón. Soporte orientable para ducha de mano. Flexo satinado. Volante cuadrado-redondo.

- 19017459 320,00
- 19017459NM 496,00
- 19017459BM 496,00
- 19017459AC 496,00
- 19017459KMB 496,00
- 19017459OM 705,00
- 19017459OPM 705,00

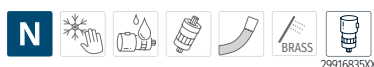

Grifo termostático sin complementos



- 19017405 273,00



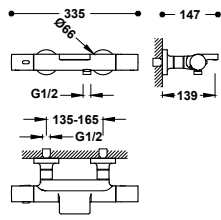

Grifo termostático mural Over-wall para bañera y ducha
 Ducha de mano anticalcárea de latón. Soporte orientable para ducha de mano. Flexo satinado. Volante redondo.

- 19017428 388,00
- 19017428NM 601,00
- 19017428BM 601,00
- 19017428AC 601,00
- 19017428KMB 601,00
- 19017428OM 854,00
- 19017428OPM 854,00



Grifo termostático sin complementos

- 19017412 341,00

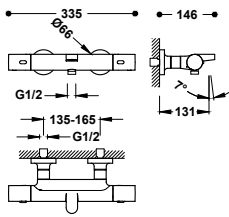

Grifo termostático mural Over-wall para bañera y ducha
 Ducha de mano anticalcárea de latón. Soporte orientable para ducha de mano. Flexo satinado. Volante redondo.

- 19017429 320,00
- 19017429NM 496,00
- 19017429BM 496,00
- 19017429AC 496,00
- 19017429KMB 496,00
- 19017429OM 705,00
- 19017429OPM 705,00



Grifo termostático sin complementos

- 19017402 273,00

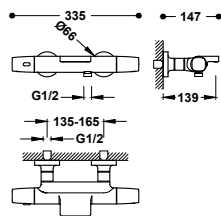

Grifo termostático mural Over-wall para bañera y ducha
 Ducha de mano anticalcárea de latón. Soporte orientable para ducha de mano. Flexo satinado. Volante con bordes redondeados.

- 19017499 388,00
- 19017499NM 601,00
- 19017499BM 601,00
- 19017499AC 601,00
- 19017499KMB 601,00
- 19017499OM 854,00
- 19017499OPM 854,00



Grifo termostático sin complementos

- 19017414 341,00



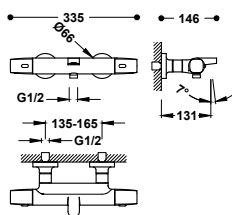

Grifo termostático mural Over-wall para bañera y ducha

Ducha de mano anticalcárea de latón. Soporte orientable para ducha de mano. Flexo satinado. Volante con bordes redondeados.

- 19017449 320,00
- 19017449NM 496,00
- 19017449BM 496,00
- 19017449AC 496,00
- 19017449KMB 496,00
- 19017449OM 705,00
- 19017449OPM 705,00

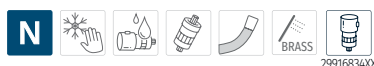

Grifo termostático sin complementos



- 19017404 273,00

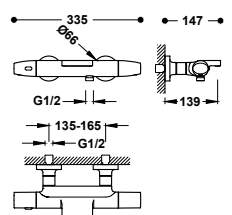

Grifo termostático mural Over-wall para bañera y ducha

Ducha de mano anticalcárea de latón. Soporte orientable para ducha de mano. Flexo satinado. Volante ovalado.

- 19017479 388,00
- 19017479NM 601,00
- 19017479BM 601,00
- 19017479AC 601,00
- 19017479KMB 601,00
- 19017479OM 854,00
- 19017479OPM 854,00

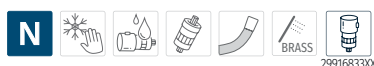

Grifo termostático sin complementos



- 19017413 341,00

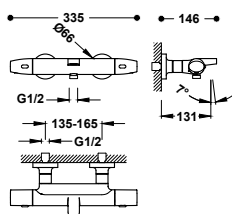

Grifo termostático mural Over-wall para bañera y ducha

Ducha de mano anticalcárea de latón. Soporte orientable para ducha de mano. Flexo satinado. Volante ovalado.

- 19017439 320,00
- 19017439NM 496,00
- 19017439BM 496,00
- 19017439AC 496,00
- 19017439KMB 496,00
- 19017439OM 705,00
- 19017439OPM 705,00

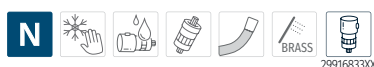

Grifo termostático sin complementos



- 19017403 273,00



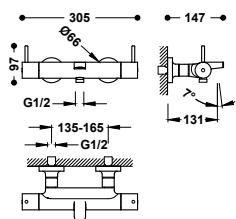

Grifo termostático mural para bañera y ducha con palancas ergonómicas

19027410

295,00

Sin complementos. Inversor integrado en el regulador de caudal. Indicado para personas con discapacidades físicas.



DESIGNED BY YOU

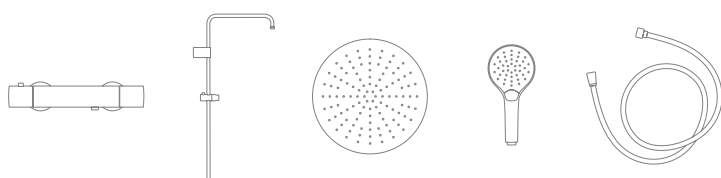

Tu grifo termostático Over-wall diseñado por ti y para ti. Un grifo personalizado para crear tu ducha perfecta.

Entra en la web para configurar tu grifo Over-wall:



1 ACABADO

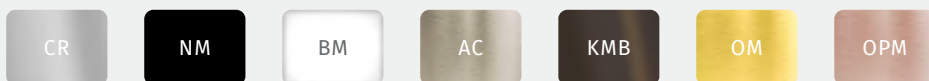

2 GRIFO TERMOSTÁTICO



3 BARRA DE DUCHA



4 ROCIADOR

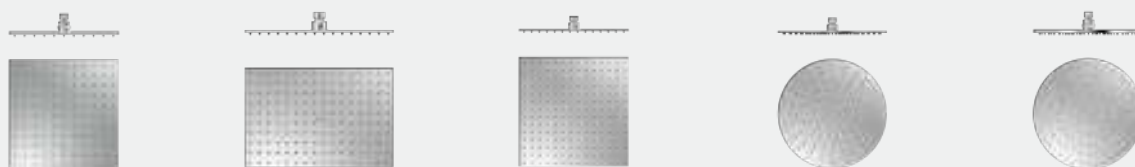

5 DUCHA DE MANO



6 FLEXO

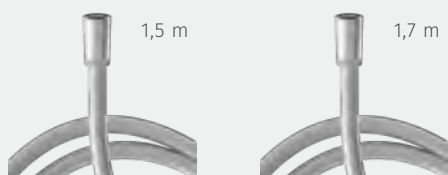



RAPID-BOX

Rapid-box es el sistema empotrado de Tres para los grifos monomando de ducha. Con diseños que combinan con todas las colecciones de Tres. Se puede adquirir la caja empotrada y la parte vista por separado; de esta manera, la planificación de la obra se simplifica y se gana en eficacia.

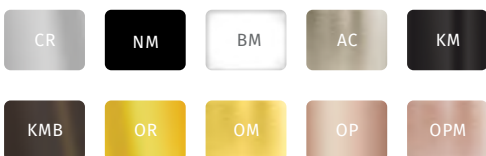





RAPID-BOX

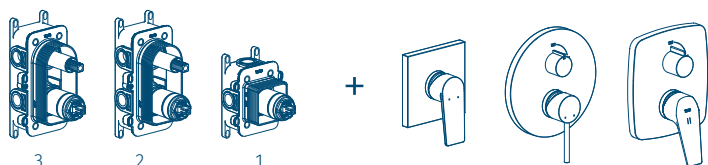

Compra por separado

Puedes instalar la caja Rapid-box y, posteriormente, adquirir la parte vista para instalarla cuando esté todo listo. De esta manera, la planificación de la obra se simplifica y se gana en eficacia.



La caja empotrada Rapid-box **permite instalarse por delante o por detrás de la pared**, tanto en paredes de obra como paredes ligeras de cartón y yeso (tipo Pladur).



Las piezas vistas tienen **poca profundidad**, permitiendo ganar más espacio útil dentro de la ducha.



Solo se necesita un **mínimo de 56 mm de profundidad** para la instalación de la caja empotrada.



Las piezas vistas están disponibles en **varios acabados** y distintos diseños que combinan con las colecciones de Tres.



La caja aísla la transmisión de temperatura del cuerpo de latón hacia la pared. Asimismo, al ser **estanca**, evita que en caso de fuga el agua se filtre por la pared. La junta impermeable **evita las humedades**.

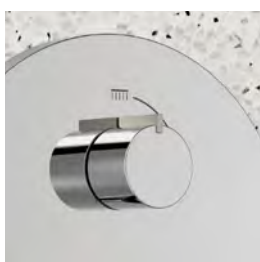

Para los monomandos de 2 y 3 vías, con un sencillo giro del distribuidor se puede cambiar entre las **2 o 3 salidas de agua disponibles**.



Los **amortiguadores** evitan la transmisión del ruido del grifo a la pared y a la tuberías.

CAJA EMPOTRADA

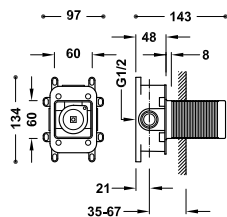

Caja empotrada de 1 vía Rapid-box con grifo monomando para ducha

20827810

80,00

Cuerpo empotrado con amortiguadores acústicos. Caja de empotrar de ABS. Junta antihumedad.



29903508

PIEZAS VISTAS DE 1 VÍA

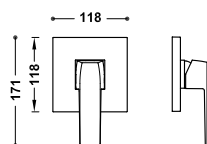

Pieza vista para caja empotrada de 1 vía Rapid-box

Sólo parte vista. Incluye placa embellecedora, mando, casquillo y tornillo de fijación oculto. Completar con la caja empotrada Rapid-box ref.: 20827810.

20227810	89,00
20227810NM	138,00
20227810BM	138,00
20227810AC	138,00
20227810KMB	138,00
20227810OR	196,00
20227810OM	196,00

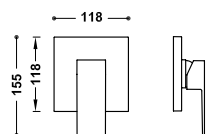

Pieza vista para caja empotrada de 1 vía Rapid-box

Sólo parte vista. Incluye placa embellecedora, mando, casquillo y tornillo de fijación oculto. Completar con la caja empotrada Rapid-box ref.: 20827810.

10627810	89,00
10627810NM	138,00
10627810BM	138,00
10627810AC	138,00
10627810OR	196,00
10627810OM	196,00

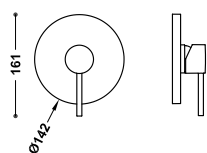

Pieza vista para caja empotrada de 1 vía Rapid-box

Sólo parte vista. Incluye placa embellecedora, mando, casquillo y tornillo de fijación oculto. Completar con la caja empotrada Rapid-box ref.: 20827810.

26227810	89,00
26227810NM	138,00
26227810BM	138,00
26227810AC	138,00
26227810KM	138,00
26227810KMB	138,00
26227810OR	196,00
26227810OM	196,00
26227810OP	196,00
26227810OPM	196,00

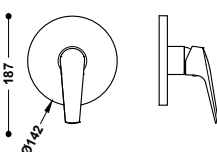

Pieza vista para caja empotrada de 1 vía Rapid-box

Sólo parte vista. Incluye placa embellecedora, mando, casquillo y tornillo de fijación oculto. Completar con la caja empotrada Rapid-box ref.: 20827810.

28127810	79,00
28127810NM	122,00
28127810AC	122,00
28127810OPM	173,00

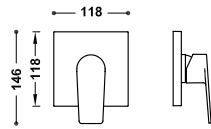

Pieza vista para caja empotrada de 1 vía Rapid-box

Sólo parte vista. Incluye placa embellecedora, mando, casquillo y tornillo de fijación oculto. Completar con la caja empotrada Rapid-box ref: 20827810.

21127810	79,00
21127810NM	122,00
21127810BM	122,00
21127810AC	122,00
21127810KM	122,00
21127810KMB	122,00
21127810OR	173,00
21127810OM	173,00
21127810OP	173,00
21127810OPM	173,00

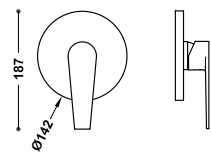

Pieza vista para caja empotrada de 1 vía Rapid-box

Sólo parte vista. Incluye placa embellecedora, mando, casquillo y tornillo de fijación oculto. Completar con la caja empotrada Rapid-box ref: 20827810.

20527810	79,00
----------	-------

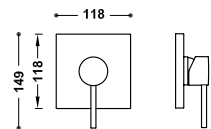

Pieza vista para caja empotrada de 1 vía Rapid-box

Sólo parte vista. Incluye placa embellecedora, mando, casquillo y tornillo de fijación oculto. Completar con la caja empotrada Rapid-box ref: 20827810.

06227810	79,00
----------	-------

CAJA EMPOTRADA

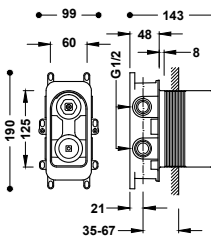

Caja empotrada de 2 vías Rapid-box con grifo monomando para ducha y bañera

Cuerpo empotrado con amortiguadores acústicos. Caja de empotrar de ABS. Junta antihumedad. Distribuidor cerámico de 2 vías.

20828110	90,00
----------	-------



PIEZAS VISTAS DE 2 VÍAS

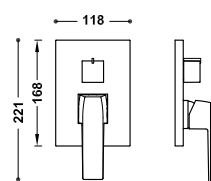

Pieza vista para caja empotrada de 2 vías Rapid-box

Sólo parte vista. Incluye placa embellecedora, mando, volante distribuidor y tornillo de fijación oculto. Completar con la caja empotrada Rapid-box ref: 20828110.

20228110	116,00
20228110NM	179,00
20228110BM	179,00
20228110AC	179,00
20228110KMB	179,00
20228110OR	254,00
20228110OM	254,00

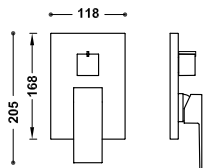

Pieza vista para caja empotrada de 2 vías Rapid-box

Sólo parte vista. Incluye placa embellecedora, mando, volante distribuidor y tornillo de fijación oculto. Completar con la caja empotrada Rapid-box ref.: 20828110.

	10628110	116,00
	10628110NM	179,00
	10628110BM	179,00
	10628110AC	179,00
	10628110OR	254,00
	10628110OM	254,00

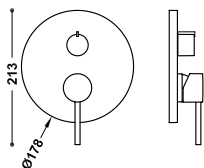

Pieza vista para caja empotrada de 2 vías Rapid-box

Sólo parte vista. Incluye placa embellecedora, mando, volante distribuidor y tornillo de fijación oculto. Completar con la caja empotrada Rapid-box ref.: 20828110.

	26228110	116,00
	26228110NM	179,00
	26228110BM	179,00
	26228110AC	179,00
	26228110KM	179,00
	26228110KMB	179,00
	26228110OR	254,00
	26228110OM	254,00
	26228110OP	254,00
	26228110OPM	254,00

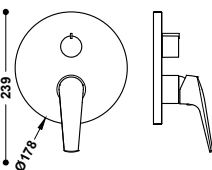

Pieza vista para caja empotrada de 2 vías Rapid-box

Sólo parte vista. Incluye placa embellecedora, mando, volante distribuidor y tornillo de fijación oculto. Completar con la caja empotrada Rapid-box ref.: 20828110.

	28128110	100,00
	28128110NM	155,00
	28128110AC	155,00
	28128110OPM	219,00

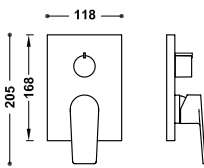

Pieza vista para caja empotrada de 2 vías Rapid-box

Sólo parte vista. Incluye placa embellecedora, mando, volante distribuidor y tornillo de fijación oculto. Completar con la caja empotrada Rapid-box ref.: 20828110.

	21128110	100,00
	21128110NM	155,00
	21128110BM	155,00
	21128110AC	155,00
	21128110KM	155,00
	21128110KMB	155,00
	21128110OR	219,00
	21128110OM	219,00
	21128110OP	219,00
	21128110OPM	219,00

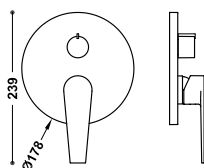

Pieza vista para caja empotrada de 2 vías Rapid-box

Sólo parte vista. Incluye placa embellecedora, mando, volante distribuidor y tornillo de fijación oculto. Completar con la caja empotrada Rapid-box ref.: 20828110.

	20528110	100,00
--	----------	--------

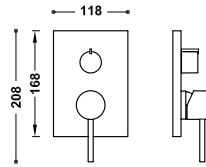

Pieza vista para caja empotrada de 2 vías Rapid-box

Sólo parte vista. Incluye placa embellecedora, mando, volante distribuidor y tornillo de fijación oculto. Completar con la caja empotrada Rapid-box ref.: 20828110.

06228110 100,00

CAJA EMPOTRADA

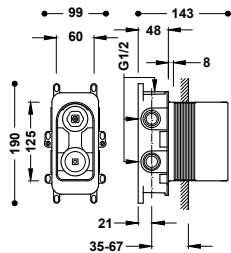

Caja empotrada de 3 vías Rapid-box con grifo monomando para ducha y bañera

Cuerpo empotrado con amortiguadores acústicos. Caja de empotrar de ABS. Junta antihumedad. Distribuidor cerámico de 3 vías.

20827310 95,00



PIEZAS VISTAS DE 3 VÍAS

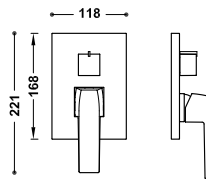

Pieza vista para caja empotrada de 3 vías Rapid-box

Sólo parte vista. Incluye placa embellecedora, mando, volante distribuidor y tornillo de fijación oculto. Completar con la caja empotrada Rapid-box ref.: 20827310.

- 20227310 125,00
- 20227310NM 194,00
- 20227310BM 194,00
- 20227310AC 194,00
- 20227310OR 275,00
- 20227310OM 275,00

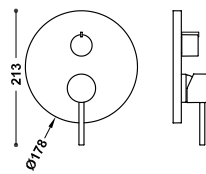

Pieza vista para caja empotrada de 3 vías Rapid-box

Sólo parte vista. Incluye placa embellecedora, mando, volante distribuidor y tornillo de fijación oculto. Completar con la caja empotrada Rapid-box ref.: 20827310.

- 26227310 125,00
- 26227310NM 194,00
- 26227310BM 194,00
- 26227310AC 194,00
- 26227310KM 194,00
- 26227310KMB 194,00
- 26227310OR 275,00
- 26227310OP 275,00
- 26227310OM 275,00
- 26227310OPM 275,00

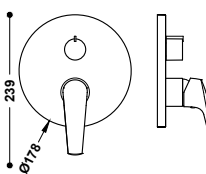

Pieza vista para caja empotrada de 3 vías Rapid-box

Sólo parte vista. Incluye placa embellecedora, mando, volante distribuidor y tornillo de fijación oculto. Completar con la caja empotrada Rapid-box ref.: 20827310.

- 28127310 109,00
- 28127310NM 169,00
- 28127310AC 169,00
- 28127310OPM 240,00



KITS DE 2 VÍAS

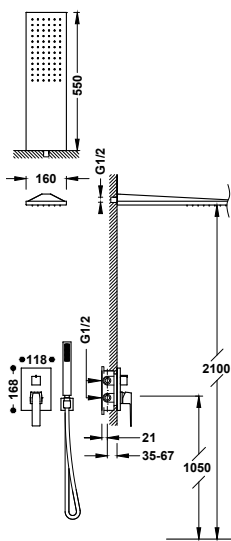

Kit de grifo monomando empotrado de 2 vías
Rapid-box para ducha

- Cuerpo empotrado incluido.
- Distribuidor cerámico de 2 vías.
- Rociador de ducha a pared de acero inoxidable: 160x550 mm.
- Soporte para ducha de mano con toma de agua a pared.
- Ducha de mano anticalcárea de latón.
- Flexo satinado.

20228005	750,00
20228005NM	1.108,00
20228005BM	1.108,00
20228005AC	1.108,00
20228005OR	1.537,00
20228005OM	1.537,00

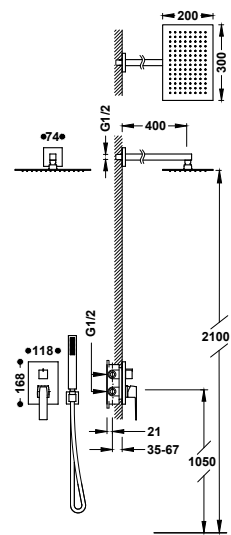
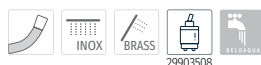

Kit de grifo monomando empotrado de 2 vías
Rapid-box para ducha

- Cuerpo empotrado incluido.
- Distribuidor cerámico de 2 vías.
- Brazo a pared con rociador de ducha orientable y de acero inoxidable: 300x200 mm.
- Soporte para ducha de mano con toma de agua a pared.
- Ducha de mano anticalcárea de latón.
- Flexo satinado.

20228004	595,00
20228004NM	868,00
20228004BM	868,00
20228004AC	868,00
20228004KMB	868,00
20228004OR	1.195,00
20228004OM	1.195,00

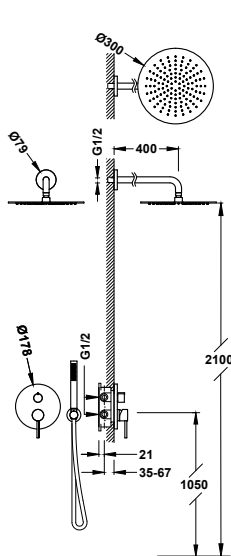
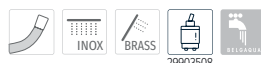

Kit de grifo monomando empotrado de 2 vías
Rapid-box para ducha

- Cuerpo empotrado incluido.
- Distribuidor cerámico de 2 vías.
- Brazo a pared con rociador de ducha orientable y de acero inoxidable: Ø 300 mm.
- Soporte para ducha de mano con toma de agua a pared.
- Ducha de mano anticalcárea de latón.
- Flexo satinado.

26228004	495,00
26228004NM	712,00
26228004BM	712,00
26228004AC	712,00
26228004KM	712,00
26228004KMB	712,00
26228004OR	977,00
26228004OM	977,00
26228004OP	977,00
26228004OPM	977,00



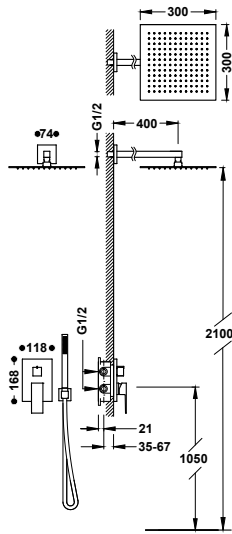

**Kit de grifo monomando empotrado de 2 vías
Rapid-box para ducha**

- Cuerpo empotrado incluido.
- Distribuidor cerámico de 2 vías.
- Brazo a pared con rociador de ducha orientable y de acero inoxidable: 300x300 mm.
- Soporte para ducha de mano con toma de agua a pared.
- Ducha de mano anticalcárea de latón.
- Flexo satinado.

00628004	582,00
00628004NM	853,00
00628004BM	853,00
00628004AC	853,00
00628004OR	1.174,00
00628004OM	1.174,00

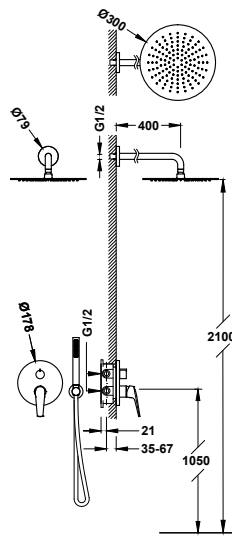

**Kit de grifo monomando empotrado de 2 vías
Rapid-box para ducha**

- Cuerpo empotrado incluido.
- Distribuidor cerámico de 2 vías.
- Brazo a pared con rociador de ducha orientable y de acero inoxidable: Ø 300 mm.
- Soporte para ducha de mano con toma de agua a pared.
- Ducha de mano anticalcárea de latón.
- Flexo satinado.

28128004	474,00
28128004NM	691,00
28128004AC	691,00
28128004OPM	947,00

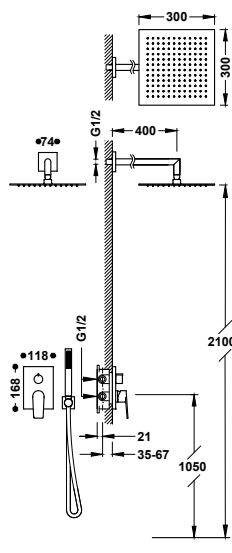

**Kit de grifo monomando empotrado de 2 vías
Rapid-box para ducha**

- Cuerpo empotrado incluido.
- Distribuidor cerámico de 2 vías.
- Brazo a pared con rociador de ducha orientable y de acero inoxidable: 300x300 mm.
- Soporte para ducha de mano con toma de agua a pared.
- Ducha de mano anticalcárea de latón.
- Flexo satinado.

21128004	540,00
21128004NM	787,00
21128004BM	787,00
21128004AC	787,00
21128004KM	787,00
21128004KMB	787,00
21128004OR	1.081,00
21128004OM	1.081,00
21128004OP	1.081,00
21128004OPM	1.081,00

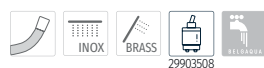

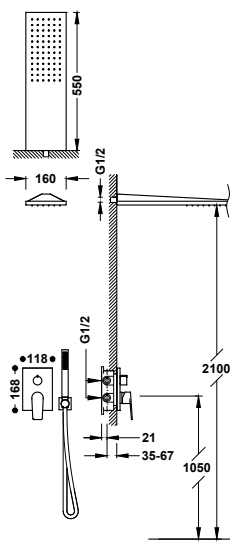

**Kit de grifo monomando empotrado de 2 vías
Rapid-box para ducha**

- Cuerpo empotrado incluido.
- Distribuidor cerámico de 2 vías.
- Rociador de ducha a pared de acero inoxidable: 160x550 mm.
- Soporte para ducha de mano con toma de agua a pared.
- Ducha de mano anticalcárea de latón.
- Flexo satinado.

■ 21128005	731,00
■ 21128005NM	1.085,00
■ 21128005BM	1.085,00
■ 21128005AC	1.085,00
■ 21128005KM	1.085,00
■ 21128005KMB	1.085,00
■ 21128005OR	1.504,00
■ 21128005OM	1.504,00
■ 21128005OP	1.504,00
■ 21128005OPM	1.504,00

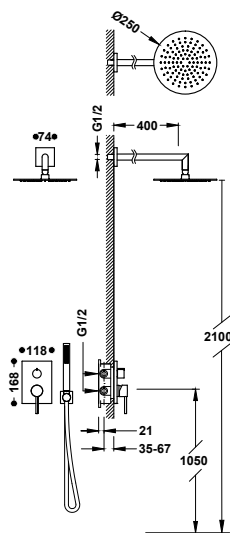
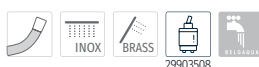

**Kit de grifo monomando empotrado de 2 vías
Rapid-box para ducha**

- Cuerpo empotrado incluido.
- Distribuidor cerámico de 2 vías.
- Brazo a pared con rociador de ducha orientable y de acero inoxidable: Ø 250 mm.
- Soporte para ducha de mano con toma de agua a pared.
- Ducha de mano anticalcárea de latón.
- Flexo satinado.

■ 06228004	427,00
------------	--------

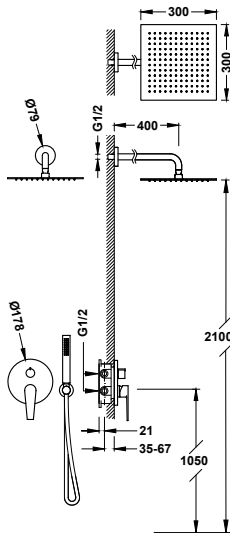

**Kit de grifo monomando empotrado de 2 vías
Rapid-box para ducha**

- Cuerpo empotrado incluido.
- Distribuidor cerámico de 2 vías.
- Brazo a pared con rociador de ducha orientable y de acero inoxidable: 300x300 mm.
- Soporte para ducha de mano con toma de agua a pared.
- Ducha de mano anticalcárea.
- Flexo satinado.

■ 20528004	452,00
------------	--------



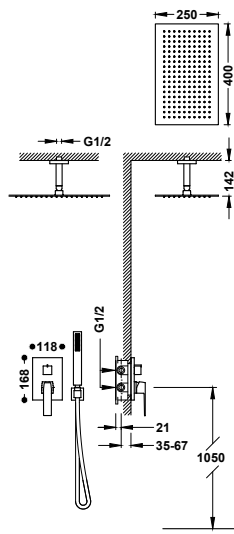

**Kit de grifo monomando empotrado de 2 vías
Rapid-box para ducha**

- Cuerpo empotrado incluido.
- Distribuidor cerámico de 2 vías.
- Brazo a techo con rociador de ducha orientable y de acero inoxidable: 400x250 mm.
- Soporte para ducha de mano con toma de agua a pared.
- Ducha de mano anticalcárea de latón.
- Flexo satinado.

20228003	621,00
20228003NM	916,00
20228003BM	916,00
20228003AC	916,00
20228003OR	1.263,00
20228003OM	1.263,00

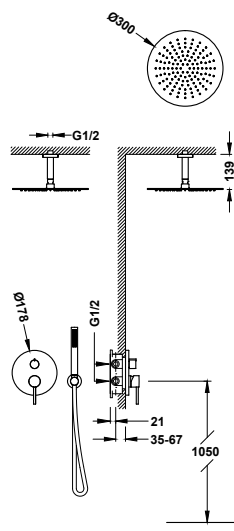
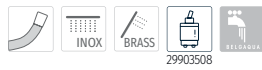

**Kit de grifo monomando empotrado de 2 vías
Rapid-box para ducha**

- Cuerpo empotrado incluido.
- Distribuidor cerámico de 2 vías.
- Brazo a techo con rociador de ducha orientable y de acero inoxidable: Ø 300 mm.
- Soporte para ducha de mano con toma de agua a pared.
- Ducha de mano anticalcárea de latón.
- Flexo satinado.

26228003	473,00
26228003NM	675,00
26228003BM	675,00
26228003AC	675,00
26228003KM	675,00
26228003KMB	675,00
26228003OR	924,00
26228003OM	924,00
26228003OP	924,00
26228003OPM	924,00

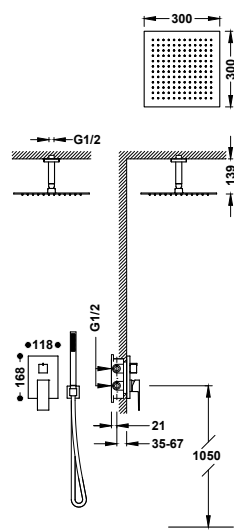

**Kit de grifo monomando empotrado de 2 vías
Rapid-box para ducha**

- Cuerpo empotrado incluido.
- Distribuidor cerámico de 2 vías.
- Brazo a techo con rociador de ducha orientable y de acero inoxidable: 300x300 mm.
- Soporte para ducha de mano con toma de agua a pared.
- Ducha de mano anticalcárea de latón.
- Flexo satinado.

00628003	559,00
00628003NM	818,00
00628003BM	818,00
00628003AC	818,00
00628003OR	1.125,00
00628003OM	1.125,00



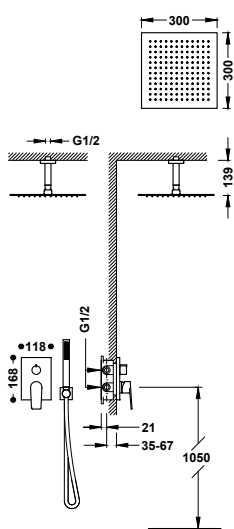

**Kit de grifo monomando empotrado de 2 vías
Rapid-box para ducha**

- Cuerpo empotrado incluido.
- Distribuidor cerámico de 2 vías.
- Brazo a techo con rociador de ducha orientable y de acero inoxidable: 300x300 mm.
- Soporte para ducha de mano con toma de agua a pared.
- Ducha de mano anticalcárea de latón.
- Flexo satinado.

21128003	506,00
21128003NM	735,00
21128003BM	735,00
21128003AC	735,00
21128003KM	735,00
21128003KMB	735,00
21128003OR	1.007,00
21128003OM	1.007,00
21128003OP	1.007,00
21128003OPM	1.007,00

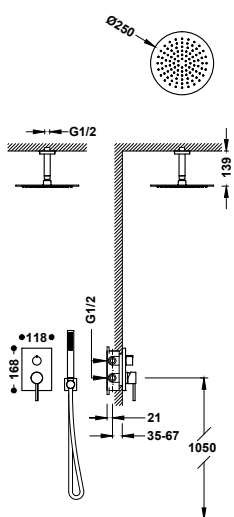
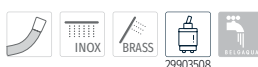

**Kit de grifo monomando empotrado de 2 vías
Rapid-box para ducha**

- Cuerpo empotrado incluido.
- Distribuidor cerámico de 2 vías.
- Brazo a techo con rociador de ducha orientable y de acero inoxidable: Ø 250 mm.
- Soporte para ducha de mano con toma de agua a pared.
- Ducha de mano anticalcárea de latón.
- Flexo satinado.

06228003	387,00
----------	--------

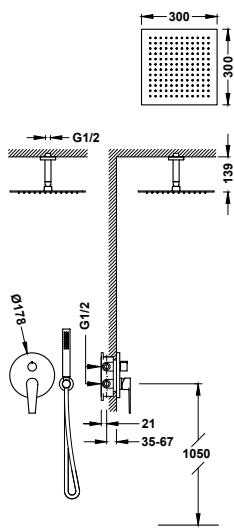

**Kit de grifo monomando empotrado de 2 vías
Rapid-box para ducha**

- Cuerpo empotrado incluido.
- Distribuidor cerámico de 2 vías.
- Brazo a techo con rociador de ducha orientable y de acero inoxidable: 300x300 mm.
- Soporte para ducha de mano con toma de agua a pared.
- Ducha de mano anticalcárea.
- Flexo satinado.

20528003	428,00
----------	--------



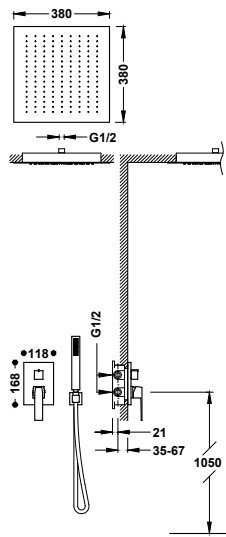

**Kit de grifo monomando empotrado de 2 vías
Rapid-box para ducha**

- Cuerpo empotrado incluido.
- Distribuidor cerámico de 2 vías.
- Rociador de ducha empotrado a techo de acero inoxidable: 380x380 mm.
- Soporte para ducha de mano con toma de agua a pared.
- Ducha de mano anticalcárea de latón.
- Flexo satinado.

20228006	1.100,00
20228006NM	1.657,00
20228006BM	1.657,00
20228006AC	1.657,00
20228006OR	2.316,00
20228006OM	2.316,00

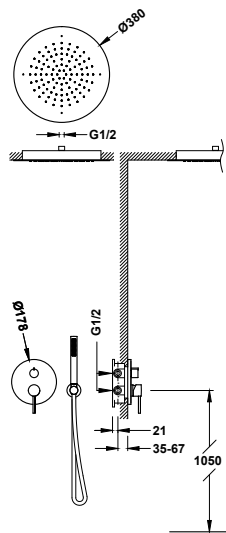
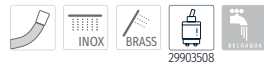

**Kit de grifo monomando empotrado de 2 vías
Rapid-box para ducha**

- Cuerpo empotrado incluido.
- Distribuidor cerámico de 2 vías.
- Rociador de ducha empotrado a techo de acero inoxidable: Ø 380 mm.
- Soporte para ducha de mano con toma de agua a pared.
- Ducha de mano anticalcárea de latón.
- Flexo satinado.

26228005	1.026,00
26228005NM	1.546,00
26228005BM	1.546,00
26228005AC	1.546,00
26228005KM	1.546,00
26228005KMB	1.546,00
26228005OR	2.160,00
26228005OM	2.160,00
26228005OP	2.160,00
26228005OPM	2.160,00

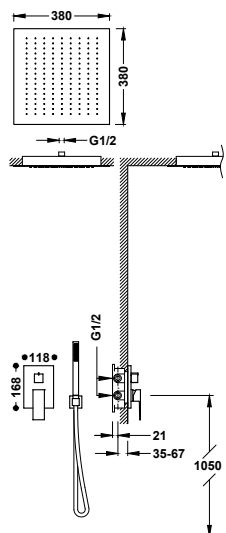

**Kit de grifo monomando empotrado de 2 vías
Rapid-box para ducha**

- Cuerpo empotrado incluido.
- Distribuidor cerámico de 2 vías.
- Rociador de ducha empotrado a techo de acero inoxidable: 380x380 mm.
- Soporte para ducha de mano con toma de agua a pared.
- Ducha de mano anticalcárea de latón.
- Flexo satinado.

00628005	1.097,00
00628005NM	1.654,00
00628005BM	1.654,00
00628005AC	1.654,00
00628005OR	2.312,00
00628005OM	2.312,00



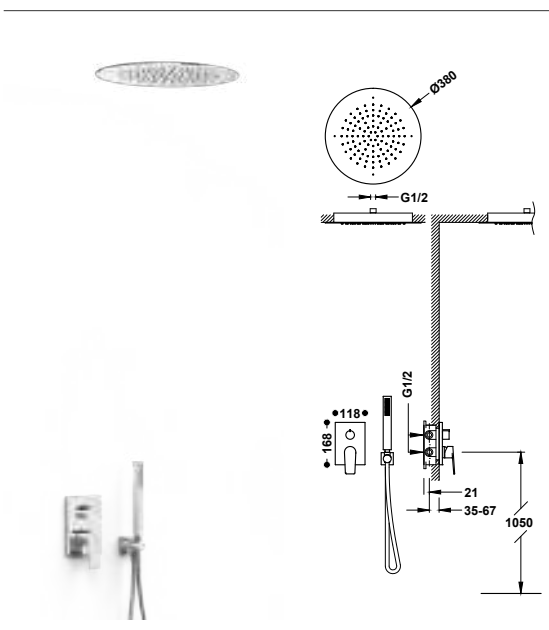

**Kit de grifo monomando empotrado de 2 vías
Rapid-box para ducha**

- Cuerpo empotrado incluido.
- Distribuidor cerámico de 2 vías.
- Rociador de ducha empotrado a techo de acero inoxidable: Ø 380 mm.
- Soporte para ducha de mano con toma de agua a pared.
- Ducha de mano anticalcárea de latón.
- Flexo satinado.

21128006	1.086,00
21128006NM	1.634,00
21128006BM	1.634,00
21128006AC	1.634,00
21128006KM	1.634,00
21128006KMB	1.634,00
21128006OR	2.282,00
21128006OM	2.282,00
21128006OP	2.282,00
21128006OPM	2.282,00

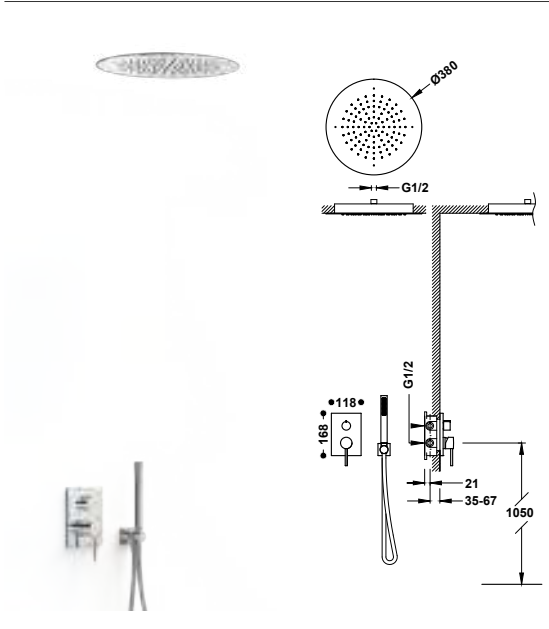
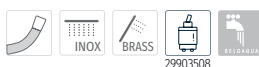

**Kit de grifo monomando empotrado de 2 vías
Rapid-box para ducha**

- Cuerpo empotrado incluido.
- Distribuidor cerámico de 2 vías.
- Rociador empotrado a techo de acero inoxidable: Ø 380 mm.
- Soporte para ducha de mano con toma de agua a pared.
- Ducha de mano anticalcárea de latón.
- Flexo satinado.

06228005	888,00
----------	--------

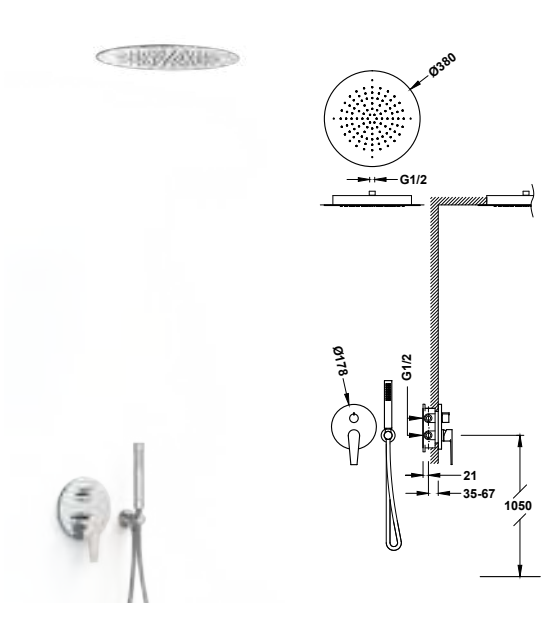

**Kit de grifo monomando empotrado de 2 vías
Rapid-box para ducha**

- Cuerpo empotrado incluido.
- Distribuidor cerámico de 2 vías.
- Rociador de ducha empotrado a techo de acero inoxidable: Ø 380 mm.
- Soporte para ducha de mano con toma de agua a pared.
- Ducha de mano anticalcárea.
- Flexo satinado.

20528005	905,00
----------	--------



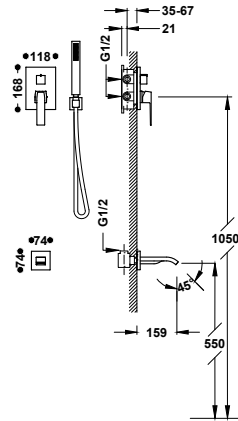

**Kit de grifo monomando empotrado de 2 vías
Rapid-box para bañera y ducha**

- Cuerpo empotrado incluido.
- Distribuidor cerámico de 2 vías.
- Caño fijo de bañera a pared.
- Soporte para ducha de mano con toma de agua a pared.
- Ducha de mano anticalcárea de latón.
- Flexo satinado.

20228007	462,00
20228007NM	651,00
20228007BM	651,00
20228007AC	651,00
20228007OR	907,00
20228007OM	907,00

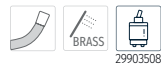

29903508

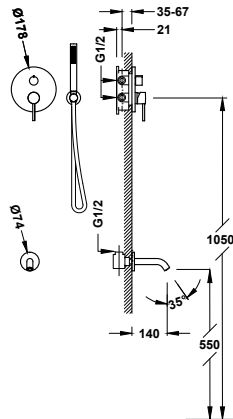

**Kit de grifo monomando empotrado de 2 vías
Rapid-box para bañera y ducha**

- Cuerpo empotrado incluido.
- Distribuidor cerámico de 2 vías.
- Caño fijo de bañera a pared.
- Soporte para ducha de mano con toma de agua a pared.
- Ducha de mano anticalcárea de latón.
- Flexo satinado.

26228006	381,00
26228006NM	545,00
26228006BM	545,00
26228006AC	545,00
26228006KM	545,00
26228006KMB	545,00
26228006OR	740,00
26228006OM	740,00
26228006OP	740,00
26228006OPM	740,00



29903508

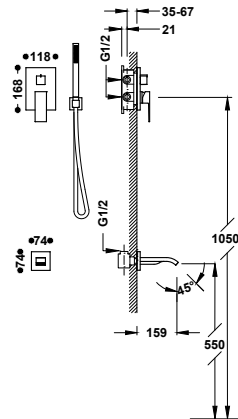

**Kit de grifo monomando empotrado de 2 vías
Rapid-box para bañera y ducha**

- Cuerpo empotrado incluido.
- Distribuidor cerámico de 2 vías.
- Caño fijo de bañera a pared.
- Soporte para ducha de mano con toma de agua a pared.
- Ducha de mano anticalcárea de latón.
- Flexo satinado.

00628006	459,00
00628006NM	662,00
00628006BM	662,00
00628006AC	662,00
00628006OR	903,00
00628006OM	903,00

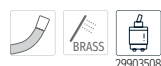

29903508

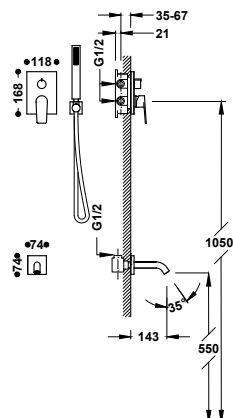

**Kit de grifo monomando empotrado de 2 vías
Rapid-box para bañera y ducha**

- Cuerpo empotrado incluido.
- Distribuidor cerámico de 2 vías.
- Caño fijo de bañera a pared.
- Soporte para ducha de mano con toma de agua a pared.
- Ducha de mano anticalcárea de latón.
- Flexo satinado.

21128007	394,00
21128007NM	560,00
21128007BM	560,00
21128007AC	560,00
21128007KM	560,00
21128007KMB	560,00
21128007OR	758,00
21128007OM	758,00
21128007OP	758,00
21128007OPM	758,00

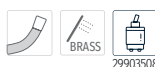

29903508

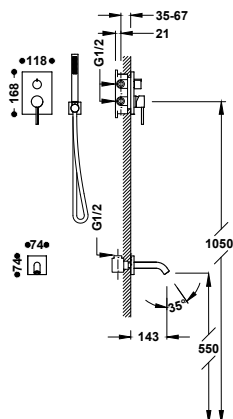

**Kit de grifo monomando empotrado de 2 vías
Rapid-box para bañera y ducha**

- Cuerpo empotrado incluido.
- Distribuidor cerámico de 2 vías.
- Caño fijo de bañera a pared.
- Soporte para ducha de mano con toma de agua a pared.
- Ducha de mano anticalcárea de latón.
- Flexo satinado.

06228006	335,00
----------	--------

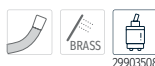

29903508

KITS DE 3 VÍAS

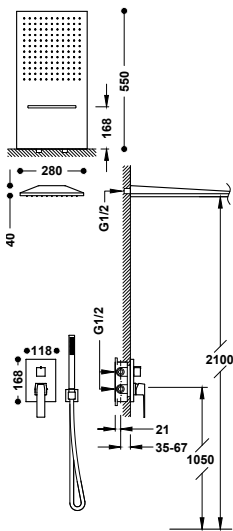

**Kit de grifo monomando empotrado de 3 vías
Rapid-box para ducha**

- Cuerpo empotrado incluido.
- Distribuidor cerámico de 3 vías.
- Rociador de ducha a pared de acero inoxidable con 2 tipos de chorro (lluvia/cascada). 280x550 mm. IMPORTANTE: Montar un desagüe de >50 l/min.
- Soporte para ducha de mano con toma de agua a pared.
- Ducha de mano anticalcárea de latón.
- Flexo satinado.

20227301	1.076,00
20227301NM	1.618,00
20227301BM	1.618,00
20227301AC	1.618,00
20227301KMB	1.618,00
20227301OR	2.258,00
20227301OM	2.258,00



29903508

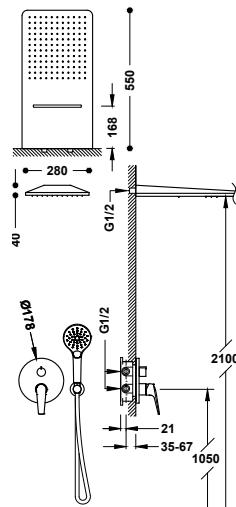

Kit de grifo monomando empotrado de 3 vías Rapid-box para ducha

- Cuerpo empotrado incluido.
- Distribuidor cerámico de 3 vías.
- Rociador de ducha a pared de acero inoxidable con 2 tipos de chorro (lluvia/cascada). 280x550 mm. **IMPORTANTE:** Montar un desagüe de >50 l/min.
- Soporte para ducha de mano con toma de agua a pared.
- Ducha de mano anticalcárea: Ø 110 mm. (3 tipos de chorro).
- Flexo satinado.

28127301	1.104,00
28127301NM	1.660,00
28127301AC	1.660,00
28127301OPM	2.318,00

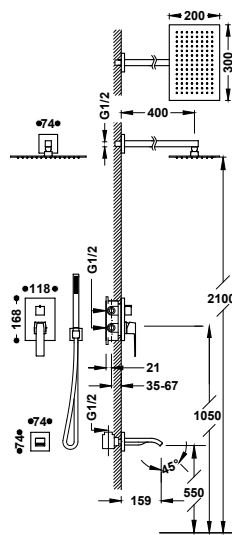

Kit de grifo monomando empotrado de 3 vías Rapid-box para ducha

- Cuerpo empotrado incluido.
- Distribuidor cerámico de 3 vías.
- Brazo a pared con rociador de ducha orientable y de acero inoxidable: 300x200 mm.
- Caño fijo de bañera a pared.
- Soporte para ducha de mano con toma de agua a pared.
- Ducha de mano anticalcárea de latón.
- Flexo satinado.

20227303	786,00
20227303NM	1.203,00
20227303BM	1.203,00
20227303AC	1.203,00
20227303OR	1.618,00
20227303OM	1.618,00

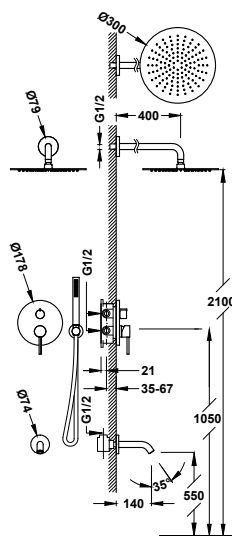

Kit de grifo monomando empotrado de 3 vías Rapid-box para ducha

- Cuerpo empotrado incluido.
- Distribuidor cerámico de 3 vías.
- Brazo a pared con rociador de ducha orientable y de acero inoxidable: Ø 300 mm.
- Caño fijo de bañera a pared.
- Soporte para ducha de mano con toma de agua a pared.
- Ducha de mano anticalcárea de latón.
- Flexo satinado.

26227302	663,00
26227302NM	946,00
26227302BM	946,00
26227302AC	946,00
26227302KM	946,00
26227302KMB	946,00
26227302OR	1.304,00
26227302OP	1.304,00
26227302OM	1.304,00
26227302OPM	1.304,00



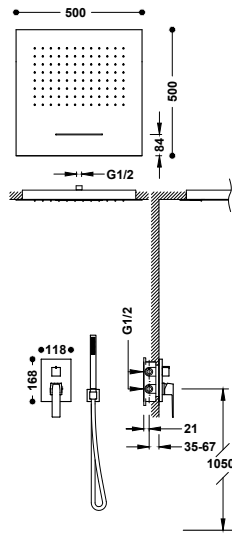

**Kit de grifo monomando empotrado de 3 vías
Rapid-box para ducha**

- Cuerpo empotrado incluido.
- Distribuidor cerámico de 3 vías.
- Rociador de ducha empotrado a techo de acero inoxidable con 2 tipos de chorro (lluvia/cascada). 500x500 mm. IMPORTANTE: Montar un desagüe de >50 l/min.
- Soporte para ducha de mano con toma de agua a pared.
- Ducha de mano anticalcárea de latón.
- Flexo satinado.

20227302	1.445,00
20227302NM	2.189,00
20227302BM	2.189,00
20227302AC	2.189,00
20227302KMB	2.189,00
20227302OR	3.069,00
20227302OM	3.069,00

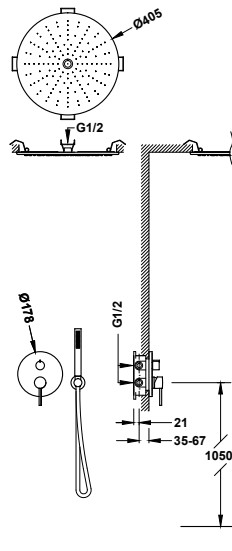

**Kit de grifo monomando empotrado de 3 vías
Rapid-box para ducha**

- Cuerpo empotrado incluido.
- Distribuidor cerámico de 3 vías.
- Rociador de ducha empotrado a techo de acero inoxidable con 2 tipos de chorro (lluvia/free flow). Ø 405 mm.
- Soporte para ducha de mano con toma de agua a pared.
- Ducha de mano anticalcárea de latón.
- Flexo satinado.

26227301	1.164,00
26227301NM	1.754,00
26227301BM	1.754,00
26227301AC	1.754,00
26227301KM	1.754,00
26227301KMB	1.754,00
26227301OR	2.450,00
26227301OP	2.450,00
26227301OM	2.450,00
26227301PM	2.450,00

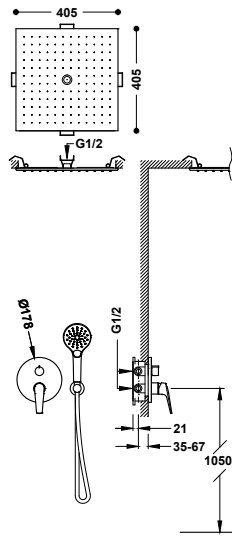

**Kit de grifo monomando empotrado de 3 vías
Rapid-box para ducha**

- Cuerpo empotrado incluido.
- Distribuidor cerámico de 3 vías.
- Rociador de ducha empotrado a techo de acero inoxidable con 2 tipos de chorro (lluvia/free flow). 405x405 mm.
- Soporte para ducha de mano con toma de agua a pared.
- Ducha de mano anticalcárea: Ø 110 mm. (3 tipos de chorro).
- Flexo satinado.

28127302	1.180,00
28127302NM	1.780,00
28127302AC	1.780,00
28127302OPM	2.486,00







MONOMANDOS MURALES

Los monomandos para la ducha son una solución sencilla y de fácil instalación con diferentes diseños y formas que se adaptan a cualquier espacio. Destacan por su funcionalidad, un manejo cómodo desde un solo mando y alta resistencia al paso del tiempo.





CONJUNTOS MONOMANDO PARA DUCHA

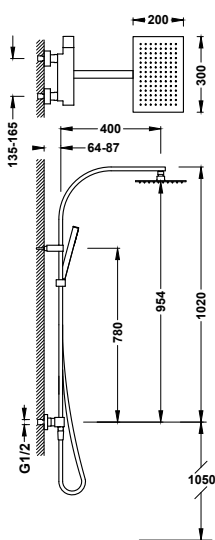

Conjunto de grifo monomando mural de 2 vías para ducha

- Rociador de ducha orientable de acero inoxidable: 300x200 mm.
- Soporte deslizante y orientable para ducha de mano.
- Ducha de mano anticalcárea de latón.
- Flexo satinado.

■ 20219101	715,00
■ 20219101NM	1.108,00
■ 20219101BM	1.108,00
■ 20219101AC	1.108,00
■ 20219101KMB	1.108,00

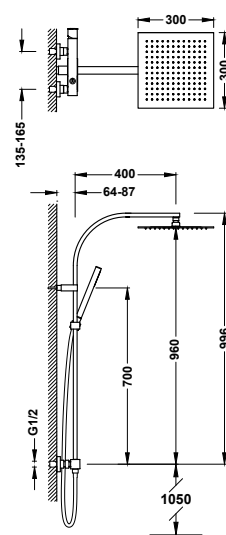
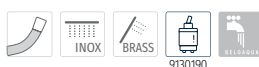

Conjunto de grifo monomando mural de 2 vías para ducha

- Rociador de ducha orientable de acero inoxidable: 300x300 mm.
- Soporte deslizante y orientable para ducha de mano.
- Ducha de mano anticalcárea de latón.
- Flexo satinado.

■ 00719102	680,00
------------	--------

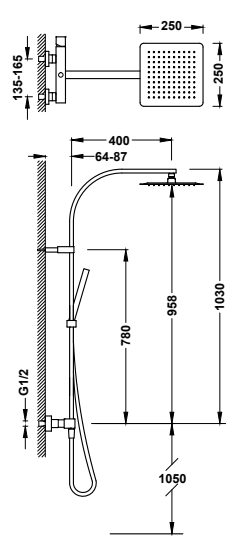

Conjunto de grifo monomando mural de 2 vías para ducha

- Rociador de ducha orientable de acero inoxidable: 250x250 mm.
- Soporte deslizante y orientable para ducha de mano.
- Ducha de mano anticalcárea de latón.
- Flexo satinado.

■ 00719101	635,00
------------	--------



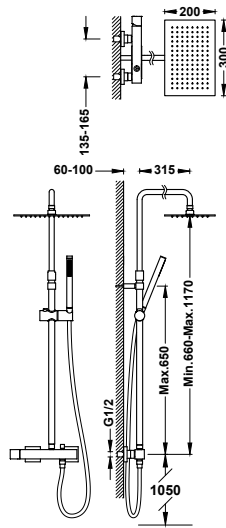

Conjunto de grifo monomando mural de 2 vías para ducha

00719702 626,00

- Rociador de ducha orientable de acero inoxidable: 300x200 mm.
- Barra de ducha telescópica.
- Soporte deslizante y orientable para ducha de mano.
- Ducha de mano anticalcárea de latón.
- Flexo satinado.

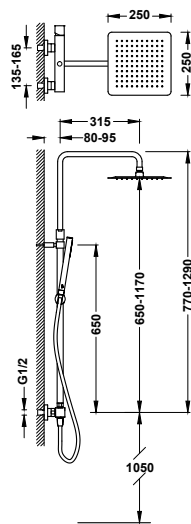

Conjunto de grifo monomando mural de 2 vías para ducha

00719701 582,00

- Rociador de ducha orientable de acero inoxidable: 250x250 mm.
- Barra de ducha telescópica.
- Soporte deslizante y orientable para ducha de mano.
- Ducha de mano anticalcárea de latón.
- Flexo satinado.

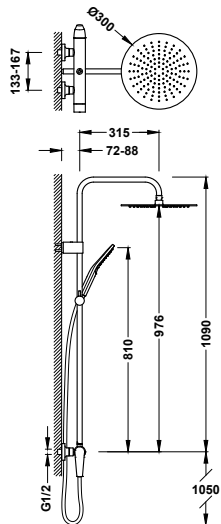

Conjunto de grifo monomando mural de 2 vías para ducha

28119101 497,00
 28119101NM 770,00
 28119101AC 770,00
 281191010PM 1.093,00

- Con inversor integrado.
- Rociador de ducha orientable de acero inoxidable: Ø 300 mm.
- Soporte deslizante y orientable para ducha de mano.
- Ducha de mano anticalcárea: Ø 110 mm. (3 tipos de chorro).
- Flexo satinado.



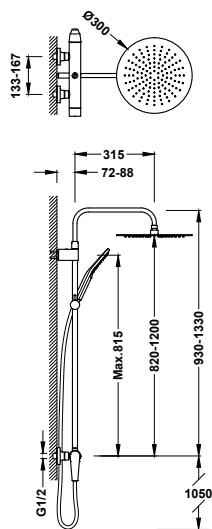

Conjunto de grifo monomando mural de 2 vías para ducha

- Con inversor integrado.
- Rociador de ducha orientable de acero inoxidable: Ø 300 mm.
- Barra de ducha telescópica.
- Soporte deslizante y orientable para ducha de mano.
- Ducha de mano anticalcárea: Ø 110 mm. (3 tipos de chorro).
- Flexo satinado.

■ 28119701	528,00
■ 28119701NM	819,00
■ 28119701AC	819,00
■ 28119701OPM	1.162,00

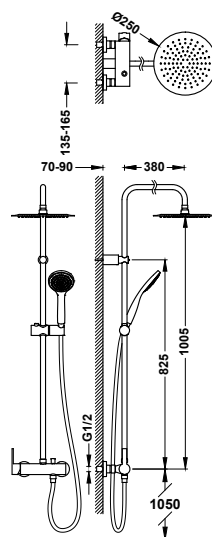

Conjunto de grifo monomando mural de 2 vías para ducha

- Rociador de ducha orientable de acero inoxidable: Ø 250 mm.
- Soporte deslizante y orientable para ducha de mano.
- Ducha de mano anticalcárea: Ø 100 mm.
- Flexo satinado.

■ 18119102	412,00
------------	--------

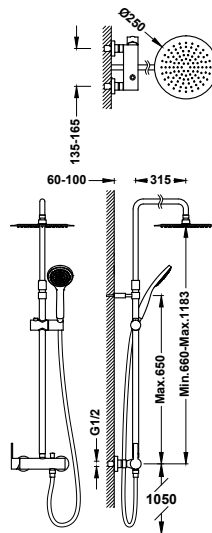

Conjunto de grifo monomando mural de 2 vías para ducha

- Rociador de ducha orientable de acero inoxidable: Ø 250 mm.
- Barra de ducha telescópica.
- Soporte deslizante y orientable para ducha de mano.
- Ducha de mano anticalcárea: Ø 100 mm.
- Flexo satinado.

■ 08119703	470,00
------------	--------



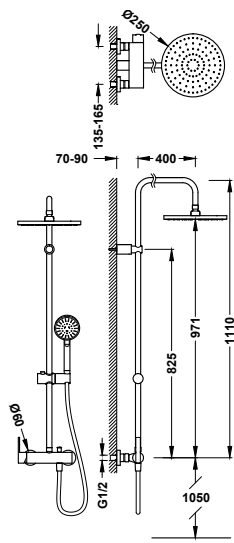

Conjunto de grifo monomando mural de 2 vías para ducha

181191

412,00

- Rociador de ducha orientable de acero inoxidable: Ø 250 mm.
- Soporte deslizante y orientable para ducha de mano.
- Ducha de mano anticalcárea: Ø 100 mm. (5 tipos de chorro).
- Flexo satinado.

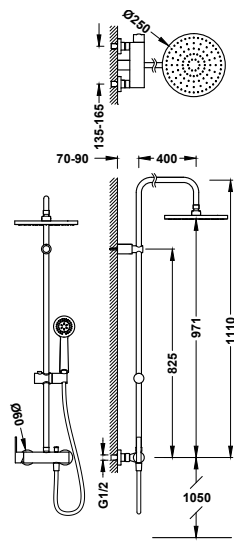

Conjunto de grifo monomando mural de 2 vías para ducha

081192

399,00

- Rociador de ducha orientable de acero inoxidable: Ø 250 mm.
- Soporte deslizante y orientable para ducha de mano.
- Ducha de mano anticalcárea: Ø 100 mm.
- Flexo metálico reforzado.

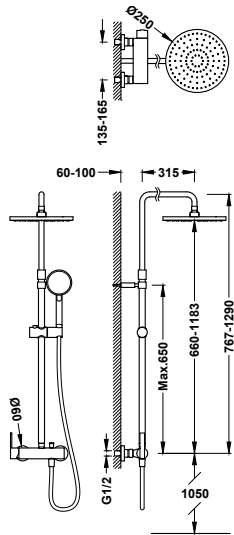

Conjunto de grifo monomando mural de 2 vías para ducha

08119702

475,00

- Rociador de ducha orientable de acero inoxidable: Ø 250 mm.
- Barra de ducha telescópica.
- Soporte deslizante y orientable para ducha de mano.
- Ducha de mano anticalcárea: Ø 100 mm. (5 tipos de chorro).
- Flexo satinado.



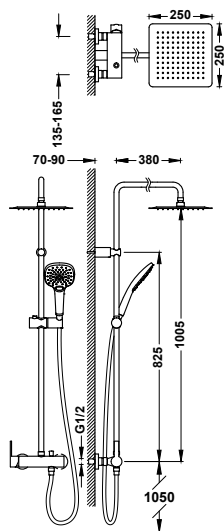

Conjunto de grifo monomando mural de 2 vías para ducha

08119302

433,00

- Rociador de ducha orientable de acero inoxidable: 250x250 mm.
- Soporte deslizante y orientable para ducha de mano.
- Ducha de mano anticalcárea: 120x120 mm. (3 tipos de chorro).
- Flexo satinado.

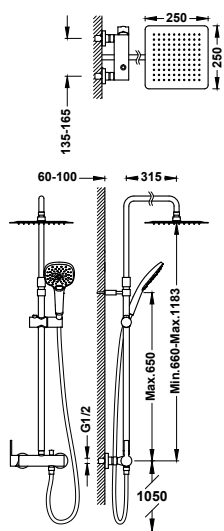

Conjunto de grifo monomando mural de 2 vías para ducha

08119704

497,00

- Rociador de ducha orientable de acero inoxidable: 250x250 mm.
- Barra de ducha telescópica.
- Soporte deslizante y orientable para ducha de mano.
- Ducha de mano anticalcárea: 120x120 mm. (3 tipos de chorro).
- Flexo satinado.

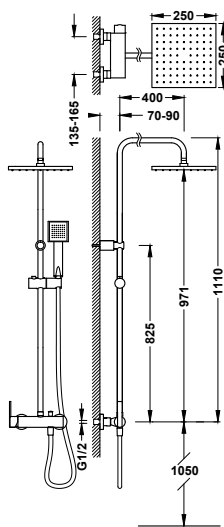

Conjunto de grifo monomando mural de 2 vías para ducha

08119301

425,00

- Rociador de ducha orientable de acero inoxidable: 250x250 mm.
- Soporte deslizante y orientable para ducha de mano.
- Ducha de mano anticalcárea: 80x80 mm.
- Flexo satinado.



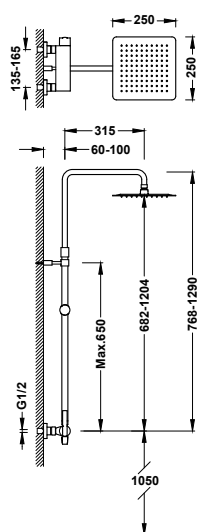

Conjunto de grifo monomando mural de 2 vías para ducha

08119701

451,00

- Rociador de ducha orientable de acero inoxidable: 250x250 mm.
- Barra de ducha telescópica.
- Soporte deslizante y orientable para ducha de mano.
- Ducha de mano anticalcárea.
- Flexo satinado.



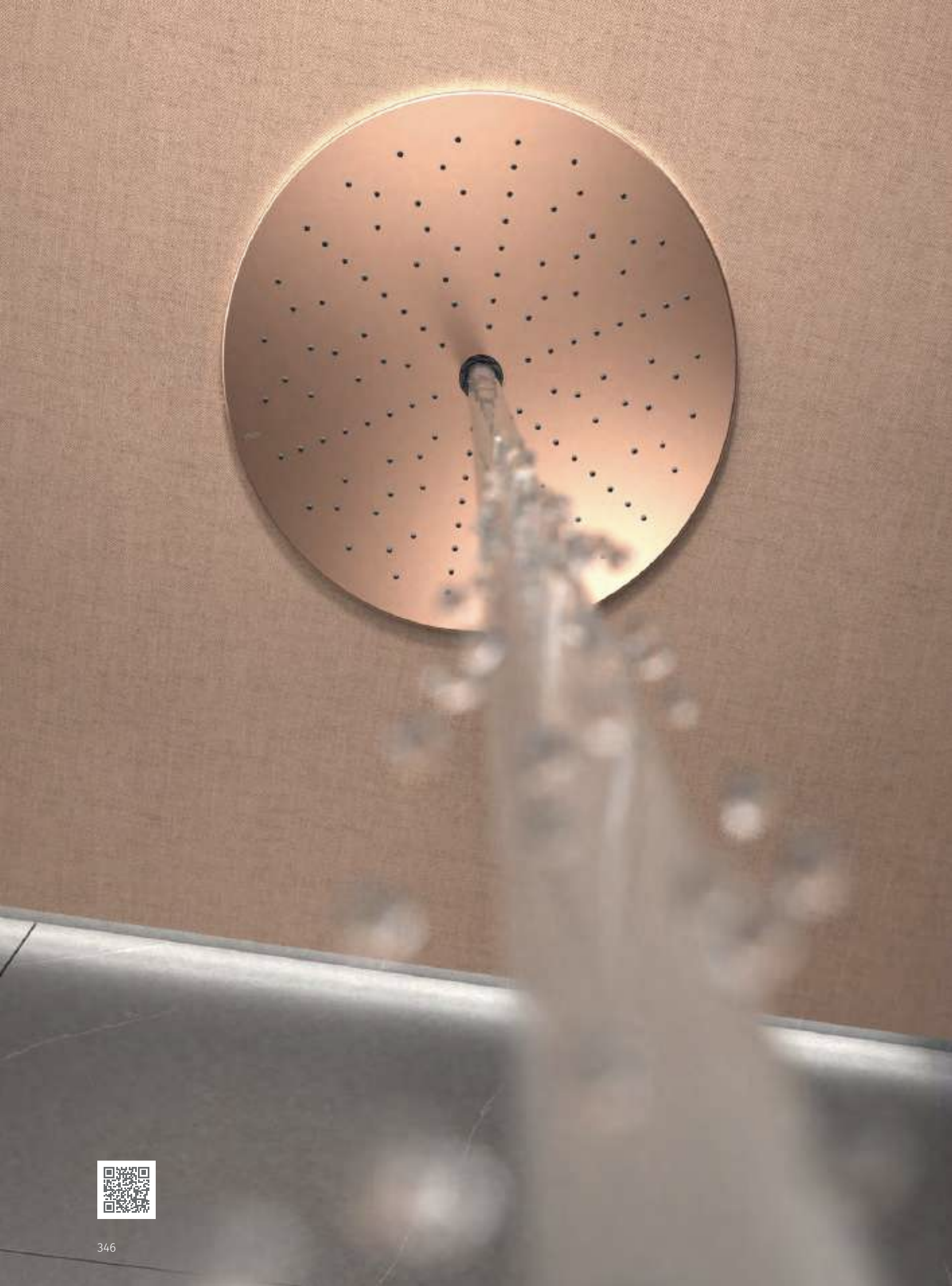

COMPLEMENTOS DE DUCHA

354 Rociadores empotrados a techo

357 Rociadores a techo

358 Rociadores a pared

361 Rociadores y brazos

371 Duchas de mano

377 Flexos

380 Barras deslizantes

390 Kits de ducha























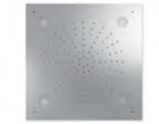















394 Soportes orientables









































395 Soportes con toma a pared

397 Codo adaptador a pared





















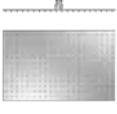



















398 Jets











































Referencia	Página	Acabados disponibles	Empotrado a techo	A pared	A techo	Material de fabricación	Dimensiones	Salidas de agua				l/min
 29997001	→354		✓			 INOX	500 x 650	2	18.5	16		
 29997201	→354		✓			 INOX	500 x 650	2	18.5	16		
 29997101	→354		✓			 INOX	500 x 650	3	18.5	16	8	
 29996201	→354		✓			 INOX	500 x 500	1	14			
 29995501	→354		✓			 INOX	500 x 500	2	20	16		
 134951	→355		✓			 INOX	500 x 500	1	24			
 13495102	→355		✓			 INOX	405 x 405	1	15			
 13495101	→355		✓			 INOX	405 x 405	1	15			
 29951607	→355		✓			 INOX	420 x 420	1	20			
 29995301	→355		✓			 INOX	380 x 380	1	20			
 134944	→356		✓			 INOX	380 x 380	1	20			
 134714	→356		✓			 BRASS	332 x 332	1	11			

Referencia	Página	Acabados disponibles	Empotrado a techo	A pared	A techo	Material de fabricación	Dimensiones	Salidas de agua					l/min
 29995801 	→356		✓				600	2	20			8	
 134950	→356		✓				500	1	24				
 13495002	→356		✓				405	1	15				
 13495001	→357		✓				405	1	15				
 134940	→357		✓				380	1	20				
 134715	→357		✓				332	1	11				
 29990301	→358			✓			280 x 550	2	12	14			
 29990302	→359			✓			210 x 550	1	12.5				
 29990303	→359			✓			160 x 550	1	12.5				
 29990308	→359			✓			280 x 550	2	12	14			
 29990307	→359			✓			210 x 550	1	12.5				
 29990306	→359			✓			160 x 550	1	12.5				





















































































Referencia	Página	Acabados disponibles	Empotrado a techo	A pared	A techo	Material de fabricación	Dimensiones	Salidas de agua					l/min
 29990304	→360			✓		 INOX	154 x 200	1		16			
 29963203	→361			✓	✓	 BRASS	450 x 315	1	14				
 134315008	→361			✓	✓	 INOX	400 x 250	1	16				
 134315007	→362			✓	✓	 INOX	300 x 200	1	12				
 134315014	→362			✓	✓	 INOX	400 x 400	1	15				
 134315012	→362			✓	✓	 INOX	300 x 300	1	12				
 13413830	→362			✓	✓	 BRASS	300 x 300	1	11				
 134315011	→362			✓	✓	 INOX	250 x 250	1	12				
 13413826	→363			✓	✓	 ABS	250 x 250	1	11				
 134315006	→363			✓	✓	 INOX	300 x 300	1	12				
 134315004	→363			✓	✓	 INOX	250 x 250	1	12				
 134315002	→363			✓	✓	 INOX	200 x 200	1	12				

Referencia	Página	Acabados disponibles	Empotrado a techo	A pared	A techo	Material de fabricación	Dimensiones	Salidas de agua					l/min
 29963206	→363			✓	✓		220 x 220	1	15				
 29943801	→364			✓	✓		242 x 242	1	12				
 134315015	→364			✓	✓		400	1	15				
 29933703	→364			✓	✓		310	1	11				
 134315010	→364			✓	✓		300	1	12				
 13413730	→364			✓	✓		300	1	11				
 134315005	→365			✓	✓		300	1	12				
 134315003	→365			✓	✓		250	1	12				
 134315009	→365			✓	✓		250	1	12				
 13413726	→365			✓	✓		250	1	11				
 13431513	→366			✓	✓		225	1	12				
 134315001	→365			✓	✓		200	1	12				



COMPLEMENTOS DE DUCHA

Referencia	Página	Acabados disponibles	Material de fabricación	Dimensiones	Número de funciones	l/min						
												
 00663901	→371				1	9.5						
 03411601	→371				1	9.5						
 913412380	→371				1	12						
 03463901	→371				1	13						
 29963108	→371				1	12						
 134748	→372			100	5	16	16.5	15.5	16	11		
 29974904	→372			130	3	7	8	5				
 29963113	→372			96 x 110	3	8.5 8+AIR 2						
 29963112	→372			110	3	8.5 8+AIR 2						
 29974906	→372			107 x 107	3	8.2	8.6	8.1				
 29974905	→373			110	3	8.8	9.6	8.8				
 29974901	→373			110	5	10	12.5	12	12.5	10		

Referencia	Página	Acabados disponibles	Material de fabricación	Dimensiones	Número de funciones	l/min					
											
 29963111	→373			120 x 120	3	10	14	9			
 29963115	→373			110	5	17	17	11	17	10	
 29963106	→374			110	5	10	10	8.5		8.5	9.5
 134627	→374			80	2	15				7	
 29963114	→374			100	3	14	14	10			
 29963109	→374			78	1	10					
 29974802	→374			100	1	9.5					
 29963105	→375			110	1	10					
 134612	→375			80 x 80	1	15					
 29963110	→375			100	1	16					
 134617	→375			80	1	15.5					
 9134725	→375			77	1	7.5					



ROCIADORES EMPOTRADOS A TECHO



Rociador de ducha empotrado a techo

Con 2 tipos de chorro (lluvia/cascada). Alimentación mediante 2 vías de agua independientes. Dimensiones: 500x650 mm. Material: Acero inoxidable. Boquillas anticálcarea.

■	29997001	1.440,00
■	29997001NM	2.232,00
■	29997001BM	2.232,00
■	29997001AC	2.232,00
■	29997001OR	3.168,00
■	29997001OM	3.168,00

500 X 650 INOX 18.5 16 l/min

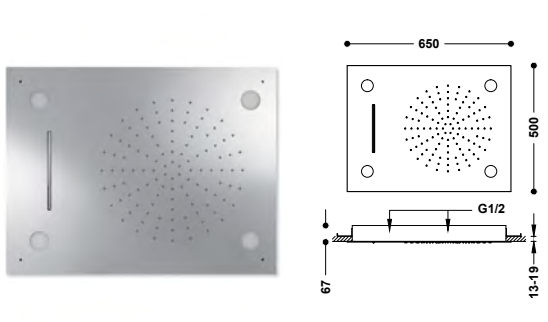

Rociador de ducha empotrado a techo con Cromoterapia

Con 2 tipos de chorro (lluvia/cascada). Alimentación mediante 2 vías de agua independientes. Dimensiones: 500x650 mm. Material: Acero inoxidable. Boquillas anticálcarea. Las luces LED se activan con un interruptor (no incluido).

■	29997201	2.440,00
---	----------	----------

500 X 650 INOX 18.5 16 l/min

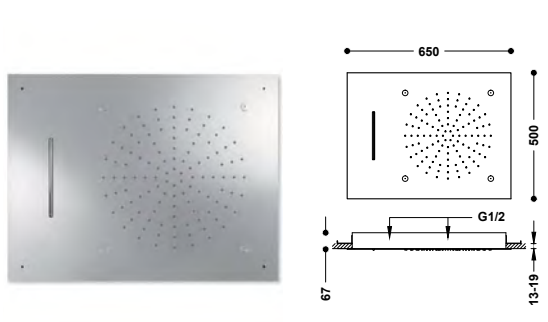

Rociador de ducha empotrado a techo

Con 3 tipos de chorro (lluvia/cascada/micro drop). Alimentación mediante 3 vías de agua independientes. Dimensiones: 500x650 mm. Material: Acero inoxidable. Boquillas anticálcarea.

■	29997101	1.540,00
---	----------	----------

500 X 650 INOX 18.5 16 8 l/min



Rociador de ducha empotrado a techo con Cromoterapia

Dimensiones: 500x500 mm. Material: Acero inoxidable. Boquillas anticálcarea. Las luces LED se activan automáticamente o con un interruptor (no incluido).

■	29996201	1.390,00
---	----------	----------

500 X 500 INOX 14 l/min



Rociador de ducha empotrado a techo

Con 2 tipos de chorro (lluvia/cascada). Alimentación mediante 2 vías de agua independientes. Dimensiones: 500x500 mm. Material: Acero inoxidable. Boquillas anticálcarea.

■	29995501	1.135,00
■	29995501NM	1.759,00
■	29995501BM	1.759,00
■	29995501AC	1.759,00
■	29995501OR	2.497,00 N
■	29995501OM	2.497,00 N

500 X 500 INOX 20 16 l/min

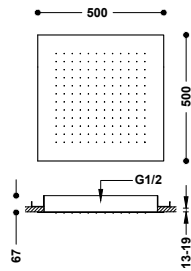

Rociador de ducha empotrado a techo

Dimensiones: 500x500 mm. Material: Acero inoxidable. Boquillas anticálcáreas.



134951	1.030,00
134951NM	1.597,00
134951BM	1.597,00
134951AC	1.597,00
134951OR	2.266,00
134951OM	2.266,00
134951OP	2.152,00 N
134951OPM	2.152,00 N

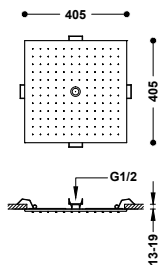

Rociador de ducha empotrado a techo

Con 2 tipos de chorro (lluvia/free flow). Alimentación mediante 2 vías de agua independientes. Dimensiones: 405x405 mm. Material: Acero inoxidable. Boquillas anticálcáreas.



13495102	895,00
13495102NM	1.387,00
13495102BM	1.387,00
13495102AC	1.387,00
13495102KM	1.387,00
13495102KMB	1.387,00
13495102OR	1.969,00
13495102OM	1.969,00
13495102OP	1.969,00
13495102OPM	1.969,00

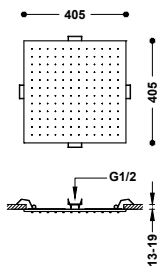

Rociador de ducha empotrado a techo

Dimensiones: 405x405 mm. Material: Acero inoxidable. Boquillas anticálcáreas.



13495101	825,00
13495101NM	1.279,00
13495101BM	1.279,00
13495101AC	1.279,00
13495101KM	1.279,00
13495101KMB	1.279,00
13495101OR	1.815,00
13495101OM	1.815,00
13495101OP	1.815,00
13495101OPM	1.815,00

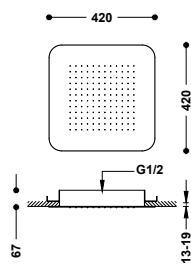

Rociador de ducha empotrado a techo

Dimensiones: 420x420 mm. Material: Acero inoxidable. Boquillas anticálcáreas.



29951607	920,00
29951607NM	1.426,00
29951607BM	1.426,00
29951607AC	1.426,00
29951607OR	2.024,00
29951607OM	2.024,00

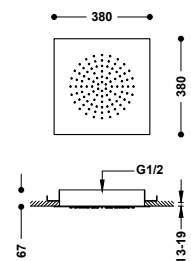

Rociador de ducha empotrado a techo

Dimensiones: 380x380 mm. Material: Acero inoxidable. Boquillas anticálcáreas.



29995301	790,00
29995301NM	1.225,00
29995301BM	1.225,00
29995301AC	1.225,00
29995301OR	1.738,00
29995301OM	1.738,00



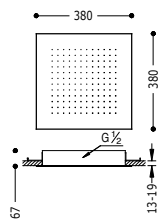

Rociador de ducha empotrado a techo

Dimensiones: 380x380 mm. Material: Acero inoxidable. Boquillas anticalcáreas.

- 134944 820,00
- 134944NM 1.271,00
- 134944BM 1.271,00
- 134944AC 1.271,00
- 134944OR 1.804,00
- 134944OM 1.804,00

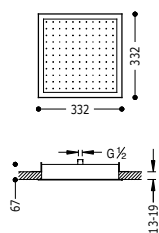

Rociador de ducha empotrado a techo

Dimensiones: 332x332 mm. Material latón. Boquillas anticalcáreas.

- 134714 530,00

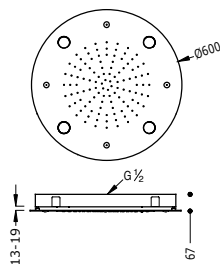

Rociador de ducha empotrado a techo con Cromoterapia

Con 2 tipos de chorro (lluvia/Micro drop). Alimentación mediante 2 vías de agua independientes. Dimensiones: Ø 600 mm. Material: Acero inoxidable. Boquillas anticalcáreas. Las luces LED se activan con un interruptor (no incluido).

- 29995801 2.440,00

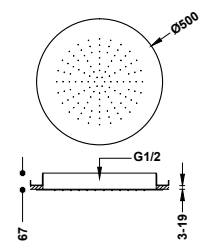

Rociador de ducha empotrado a techo

Dimensiones: Ø 500 mm. Material: Acero inoxidable. Boquillas anticalcáreas.

- 134950 1.030,00
- 134950NM 1.597,00
- 134950BM 1.597,00
- 134950AC 1.597,00
- 134950OR 2.266,00
- 134950OM 2.266,00

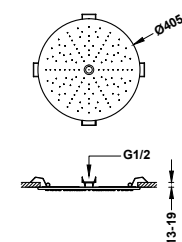

Rociador de ducha empotrado a techo

Con 2 tipos de chorro (lluvia/free flow). Alimentación mediante 2 vías de agua independientes. Dimensiones: Ø 405 mm. Material: Acero inoxidable. Boquillas anticalcáreas.

- 13495002 861,00
- 13495002NM 1.335,00
- 13495002BM 1.335,00
- 13495002AC 1.335,00
- 13495002KM 1.335,00
- 13495002KMB 1.335,00
- 13495002OR 1.894,00
- 13495002OM 1.894,00
- 13495002OP 1.894,00
- 13495002OPM 1.894,00



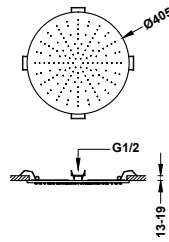

Rociador de ducha empotrado a techo

Dimensiones: Ø 405 mm. Material: Acero inoxidable. Boquillas anticálcáreas.



13495001	775,00
13495001NM	1.201,00
13495001BM	1.201,00
13495001AC	1.201,00
13495001KM	1.201,00
13495001KMB	1.201,00
13495001OR	1.705,00
13495001OM	1.705,00
13495001OP	1.705,00
13495001OPM	1.705,00

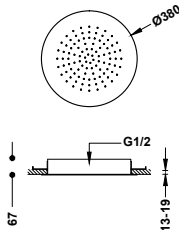

Rociador de ducha empotrado a techo

Dimensiones: Ø 380 mm. Material: Acero inoxidable. Boquillas anticálcáreas.

134940	820,00
134940NM	1.271,00
134940BM	1.271,00
134940AC	1.271,00
134940KM	1.271,00
134940KMB	1.271,00
134940OR	1.804,00
134940OM	1.804,00
134940OP	1.804,00
134940OPM	1.804,00

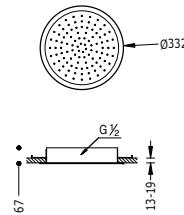

Rociador de ducha empotrado a techo

Dimensiones: Ø 332 mm. Material latón. Boquillas anticálcáreas.

134715	530,00
--------	--------

ROCIADORES A TECHO

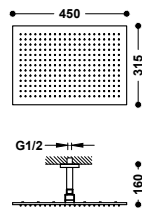

Brazo a techo con rociador de ducha orientable

Brazo a techo: 160 mm. Rociador de ducha orientable: 450x315 mm. Material: Latón.

03443203	425,00
----------	--------

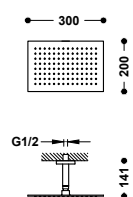

Brazo a techo con rociador de ducha orientable

Brazo a techo: 141 mm. Rociador de ducha orientable: 300x200 mm. Material: Acero inoxidable.

03443202	270,00
----------	--------



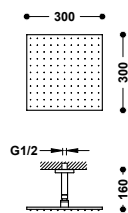

Brazo a techo con rociador de ducha orientable

03483102 318,00

Brazo a techo: 157 mm. Rociador de ducha orientable: 300x300 mm. Material: Latón.

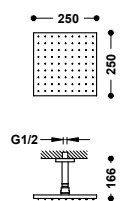

Brazo a techo con rociador de ducha orientable

03412102 142,00

Brazo a techo: 166 mm. Rociador de ducha orientable: 250x250 mm.

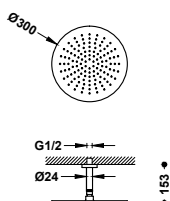

Brazo a techo con rociador de ducha orientable

134331 185,00

Brazo a techo: 153 mm. Rociador de ducha orientable: Ø 300 mm. Material: Acero inoxidable.

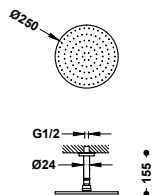

Brazo a techo con rociador de ducha orientable

134221 125,00

Brazo a techo: 155 mm. Rociador de ducha orientable: Ø 250 mm.



ROCIADORES A PARED

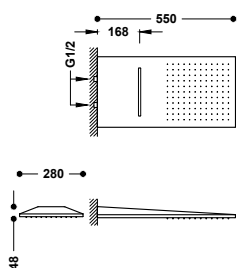

Rociador de ducha a pared

29990301 755,00

Con 2 tipos de chorro (lluvia/cascada). Alimentación mediante 2 vías de agua independientes. Dimensiones: 280x550 mm. Material: Acero inoxidable. Boquillas anticálcarea.

29990301NM 1.170,00

29990301BM 1.170,00

29990301AC 1.170,00

29990301OR 1.661,00

29990301OM 1.661,00

29990301OPM 1.661,00



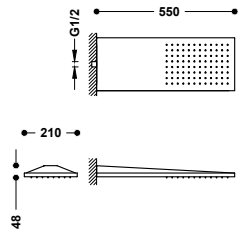

Rociador de ducha a pared

Dimensiones: 210x550 mm. Material: Acero inoxidable. Boquillas anticalcáreas.



- 29990302 555,00
- 29990302NM 860,00
- 29990302BM 860,00
- 29990302AC 860,00
- 29990302OR 1.221,00
- 29990302OM 1.221,00
- 29990302OPM 1.221,00 **N**

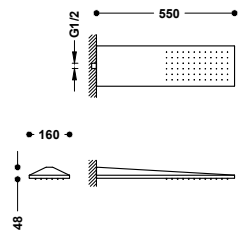

Rociador de ducha a pared

Dimensiones: 160x550 mm. Material: Acero inoxidable. Boquillas anticalcáreas.



- 29990303 455,00
- 29990303NM 705,00
- 29990303BM 705,00
- 29990303AC 705,00
- 29990303KM 705,00
- 29990303KMB 705,00
- 29990303OR 1.001,00
- 29990303OM 1.001,00
- 29990303OP 1.001,00
- 29990303OPM 1.001,00

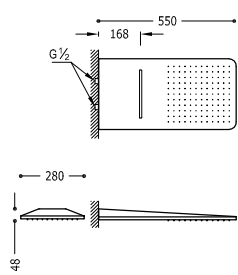

Rociador de ducha a pared

Con 2 tipos de chorro (lluvia/cascada). Alimentación mediante 2 vías de agua independientes. Dimensiones: 280x550 mm. Material: Acero inoxidable. Boquillas anticalcáreas.



- 29990308 815,00
- 29990308NM 1.263,00
- 29990308BM 1.263,00
- 29990308AC 1.263,00
- 29990308OR 1.793,00
- 29990308OM 1.793,00
- 29990308OP 1.793,00
- 29990308OPM 1.793,00 **N**

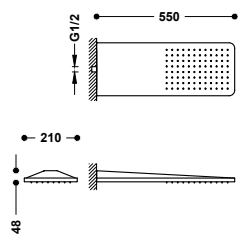

Rociador de ducha a pared

Dimensiones: 210x550 mm. Material: Acero inoxidable. Boquillas anticalcáreas.



- 29990307 615,00
- 29990307NM 953,00
- 29990307BM 953,00
- 29990307AC 953,00
- 29990307KM 953,00
- 29990307KMB 953,00
- 29990307OR 1.353,00
- 29990307OM 1.353,00
- 29990307OP 1.353,00
- 29990307OPM 1.353,00

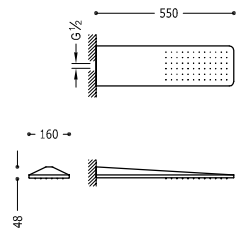

Rociador de ducha a pared

Dimensiones: 160x550 mm. Material: Acero inoxidable. Boquillas anticalcáreas.



- 29990306 515,00
- 29990306NM 798,00
- 29990306BM 798,00
- 29990306AC 798,00
- 29990306OR 1.133,00
- 29990306OM 1.133,00



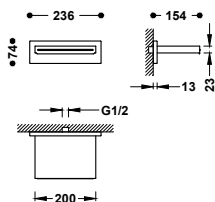

Rociador de ducha a pared

Con salida del agua en cascada. Material: Acero inoxidable.
Dimensiones: 154x200 mm.



- 29990304 450,00
- 29990304NM 698,00
- 29990304BM 698,00
- 29990304AC 698,00
- 29990304KMB 698,00
- 29990304OR 990,00
- 29990304OM 990,00
- 29990304OPM 990,00

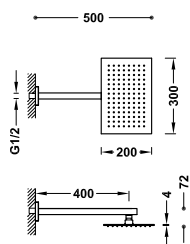

Brazo a pared con rociador de ducha orientable

Brazo a pared: 400 mm. Rociador de ducha orientable: 300x200 mm. Material: Acero inoxidable.

29953202 295,00

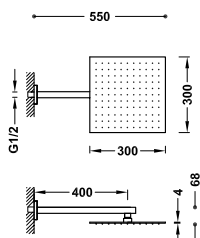

Brazo a pared con rociador de ducha orientable

Brazo a pared: 400 mm. Rociador de ducha orientable: 300x300 mm. Material: Acero inoxidable.

134433 340,00

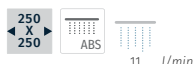
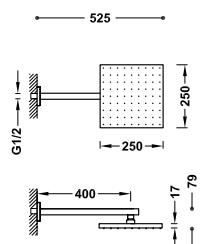

Brazo a pared con rociador de ducha orientable

Brazo a pared: 400 mm. Rociador de ducha orientable: 250x250 mm.

134233 163,00

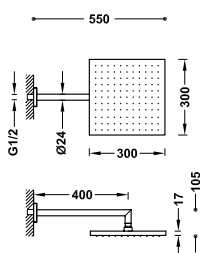

Brazo a pared con rociador de ducha orientable

Brazo a pared: 400 mm. Rociador de ducha orientable: 300x300 mm. Material: Latón.

03443101 350,00

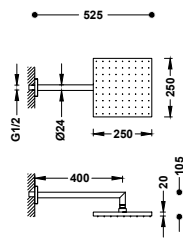

Brazo a pared con rociador de ducha orientable
 Brazo a pared: 400 mm. Rociador de ducha orientable: 250x250 mm.

03423101 159,00

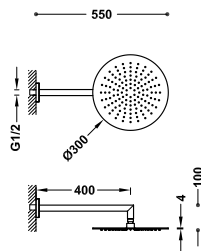
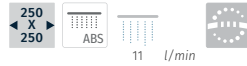

Brazo a pared con rociador de ducha orientable
 Brazo a pared: 400 mm. Rociador de ducha orientable: Ø 300 mm. Material: Acero inoxidable.

134432 220,00

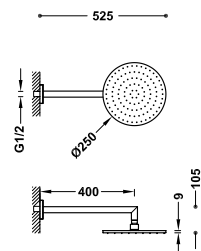

Brazo a pared con rociador de ducha orientable
 Brazo a pared: 400 mm. Rociador de ducha orientable: Ø 250 mm.

134232 151,00



ROCIADORES Y BRAZOS

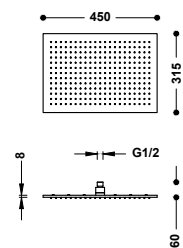

Rociador de ducha
 Dimensiones: 450x315 mm. Rótula orientable. Material: Latón. Boquillas anticalcáreas.

- 29963203 360,00
- 29963203NM 558,00
- 29963203BM 558,00
- 29963203AC 558,00
- 29963203OR 792,00
- 29963203OM 792,00

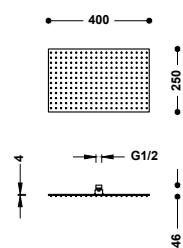
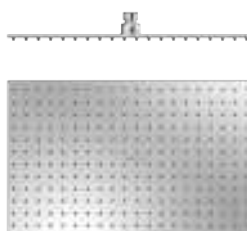

Rociador de ducha
 Extrafino: 4 mm. Dimensiones: 400x250 mm. Rótula orientable. Material: Acero inoxidable. Boquillas anticalcáreas.

- 134315008 260,00
- 134315008NM 403,00
- 134315008BM 403,00
- 134315008AC 403,00
- 134315008OR 572,00
- 134315008OM 572,00



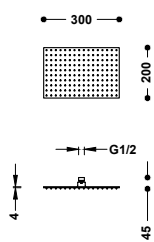
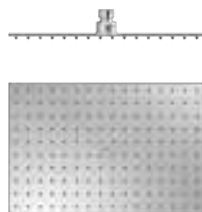

Rociador de ducha

Extrafino: 4 mm. Dimensiones: 300x200 mm. Rótula orientable. Material: Acero inoxidable. Boquillas anticalcáreas.



- 134315007 205,00
- 134315007NM 318,00
- 134315007BM 318,00
- 134315007AC 318,00
- 134315007KMB 318,00
- 134315007OR 451,00
- 134315007OM 451,00
- 134315007OP 451,00
- 134315007OPM 451,00

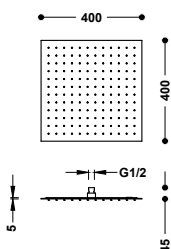
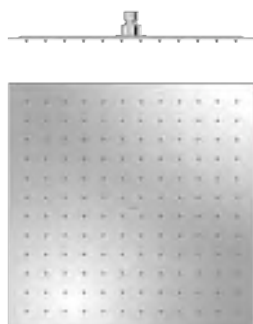

Rociador de ducha

Dimensiones: 400x400 mm. Rótula orientable. Material: Acero inoxidable. Incorpora una válvula de alivio de presión de membrana. Boquillas anticalcáreas.



- 134315014 220,00

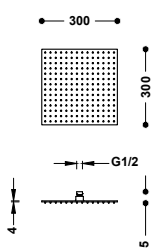
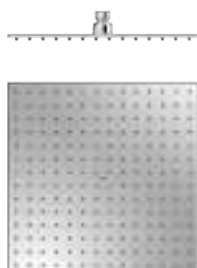

Rociador de ducha

Extrafino: 4 mm. Dimensiones: 300x300 mm. Rótula orientable. Material: Acero inoxidable. Boquillas anticalcáreas.



- 134315012 172,00
- 134315012NM 267,00
- 134315012BM 267,00
- 134315012AC 267,00
- 134315012KM 267,00
- 134315012KMB 267,00
- 134315012OR 378,00
- 134315012OM 378,00
- 134315012OP 378,00
- 134315012OPM 378,00

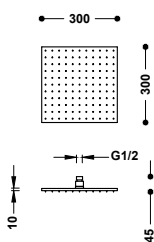
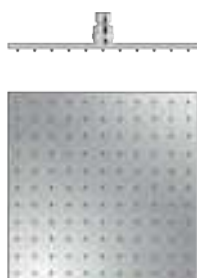

Rociador de ducha

Dimensiones: 300x300 mm. Rótula orientable. Material: Latón. Boquillas anticalcáreas.



- 13413830 268,00
- 13413830NM 415,00
- 13413830BM 415,00
- 13413830AC 415,00
- 13413830KM 415,00
- 13413830KMB 415,00
- 13413830OR 590,00
- 13413830OM 590,00
- 13413830OP 590,00
- 13413830OPM 590,00

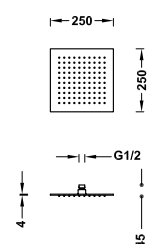
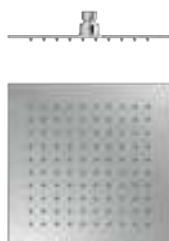

Rociador de ducha

Extrafino: 4 mm. Dimensiones: 250x250 mm. Rótula orientable. Material: Acero inoxidable. Boquillas anticalcáreas.



- 134315011 145,00

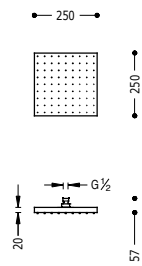
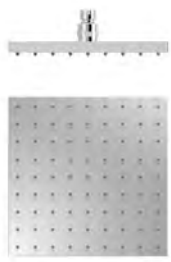

Rociador de ducha

13413826

82,00

Dimensiones: 250x250 mm. Rótula orientable. Boquillas anticalcáreas.

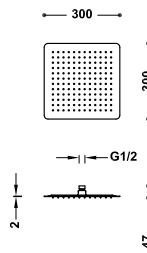
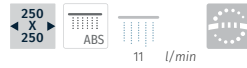

Rociador de ducha

134315006

149,00

Dimensiones: 300x300 mm. Rótula orientable. Material: Acero inoxidable. Boquillas anticalcáreas.

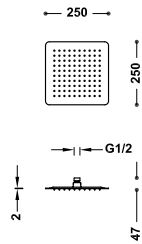

Rociador de ducha

134315004

125,00

Dimensiones: 250x250 mm. Rótula orientable. Material: Acero inoxidable. Boquillas anticalcáreas.

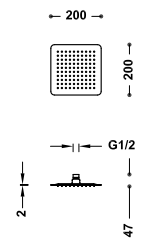

Rociador de ducha

134315002

77,00

Dimensiones: 200x200 mm. Rótula orientable. Material: Acero inoxidable. Boquillas anticalcáreas.

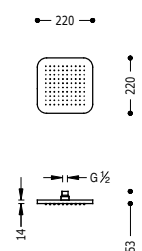

Rociador de ducha

29963206

135,00

Dimensiones: 220x220 mm. Rótula orientable. Boquillas anticalcáreas.

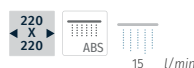





Rociador de ducha

Dimensiones: 242x242 mm. Rótula orientable. Boquillas anticalcáreas.

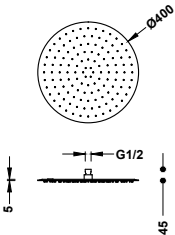

29943801 54,00

Rociador de ducha

Dimensiones: Ø 400 mm. Rótula orientable. Material: Acero inoxidable. Incorpora una válvula de alivio de presión de membrana. Boquillas anticalcáreas.



134315015 172,00





Rociador de ducha Clasic

Dimensiones: Ø 310 mm. Rótula orientable. Material: Latón. Boquillas anticalcáreas.

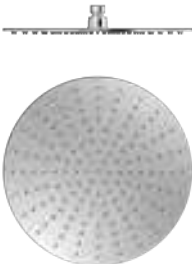
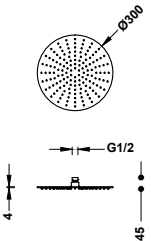

29933703 268,00
 29933703AC 415,00
 29933703OR 590,00
 29933703LV 389,00
 29933703LM 389,00

Rociador de ducha

Extrafino: 4 mm. Dimensiones: Ø 300 mm. Rótula orientable. Material: Acero inoxidable. Boquillas anticalcáreas.



134315010 145,00
 134315010NM 225,00
 134315010BM 225,00
 134315010AC 225,00
 134315010KM 225,00
 134315010KMB 225,00
 134315010OR 319,00
 134315010OM 319,00
 134315010OP 319,00
 134315010OPM 319,00





Rociador de ducha

Dimensiones: Ø 300 mm. Rótula orientable. Material: Latón. Boquillas anticalcáreas.

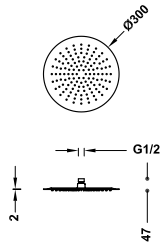

13413730 256,00
 13413730NM 397,00
 13413730BM 397,00
 13413730AC 397,00
 13413730KM 397,00
 13413730KMB 397,00
 13413730OR 563,00
 13413730OM 563,00
 13413730OP 563,00
 13413730OPM 563,00



Rociador de ducha

134315005

130,00

Dimensiones: Ø 300 mm. Rótula orientable. Material: Acero inoxidable. Boquillas anticalcáreas.

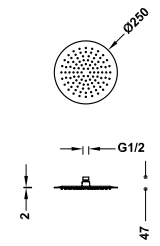

Rociador de ducha

134315003

103,00

Dimensiones: Ø 250 mm. Rótula orientable. Material: Acero inoxidable. Boquillas anticalcáreas.

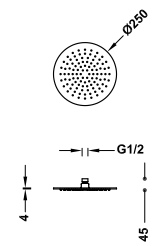

Rociador de ducha

134315009

98,00

Extrafino: 4 mm. Dimensiones: Ø 250 mm. Rótula orientable. Material: Acero inoxidable. Boquillas anticalcáreas.

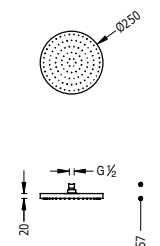

Rociador de ducha

13413726

82,00

Dimensiones: Ø 250 mm. Rótula orientable. Boquillas anticalcáreas.

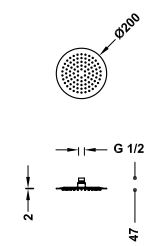

Rociador de ducha

134315001

57,00

Dimensiones: Ø 200 mm. Rótula orientable. Material: Acero inoxidable. Boquillas anticalcáreas.



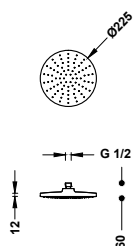

Rociador de ducha Autoclean

13431513

46,00

Dimensiones: Ø 225 mm. Rótula orientable. Boquillas anticalcáreas autolimpiables.

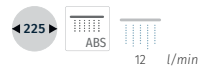

BOQUILLAS ANTICALCÁREAS AUTOLIMPIABLES

Cada vez que se cierra el grifo, unas pequeñas púas tapan las boquillas para limpiarlas y dejarlas libres cuando vuelva a salir el agua.

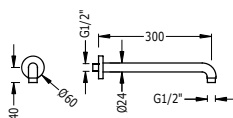

Brazo a pared

13462101

65,00

Para rociador de ducha. Longitud: 300 mm.

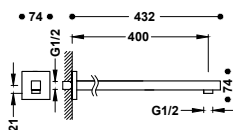

Brazo a pared

13413940

90,00

Para rociador de ducha. Longitud: 400 mm.

- 13413940NM 140,00
- 13413940BM 140,00
- 13413940AC 140,00
- 13413940OR 198,00
- 13413940OM 198,00
- 13413940OPM 198,00

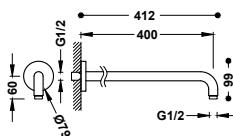

Brazo a pared

13462104

77,00

Para rociador de ducha. Longitud: 400 mm.

- 13462104NM 119,00
- 13462104BM 119,00
- 13462104AC 119,00
- 13462104KM 119,00
- 13462104KMB 119,00
- 13462104OR 169,00
- 13462104OM 169,00
- 13462104OP 169,00
- 13462104OPM 169,00

Brazo a pared

Para rociador de ducha. Longitud: 390 mm.

13463302

79,00

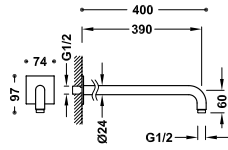

Brazo a pared

Para rociador de ducha. Longitud: 390 mm.

13463303

77,00

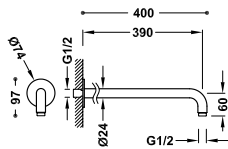

Brazo a pared

Para rociador de ducha. Longitud: 390 mm.

13463301

79,00

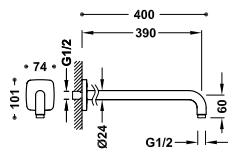

Brazo a pared

Para rociador de ducha. Longitud: 400 mm.

16118740

77,00

16118740NM

119,00

16118740BM

119,00

16118740AC

119,00

16118740KMB

119,00

16118740OR

169,00

16118740OM

169,00

16118740OP

169,00

16118740OPM

169,00

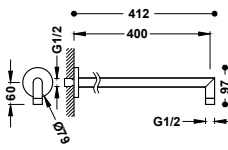

Brazo a pared

Para rociador de ducha. Longitud: 400 mm.

29963902

85,00

29963902NM

132,00

29963902BM

132,00

29963902AC

132,00

29963902KMB

132,00

29963902OR

187,00

29963902OM

187,00

29963902OP

187,00

29963902OPM

187,00

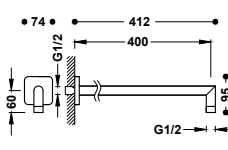

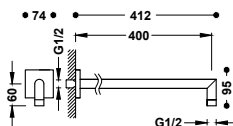

Brazo a pared

Para rociador de ducha. Longitud: 400 mm.

06243201	85,00
06243201NM	132,00
06243201BM	132,00
06243201AC	132,00
06243201KM	132,00
06243201KMB	132,00
06243201OR	187,00
06243201OM	187,00
06243201OP	187,00
06243201OPM	187,00

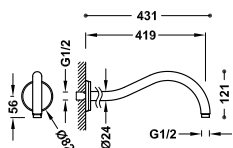

Brazo a pared Clasic

Para rociador de ducha. Longitud: 419 mm.

29933701	84,00
29933701AC	130,00
29933701OR	185,00
29933701LV	122,00
29933701LM	122,00

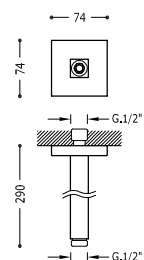

Brazo a techo

Para rociador de ducha. Longitud: 290 mm.

13462202	77,00
13462202NM	119,00
13462202BM	119,00
13462202AC	119,00
13462202OR	169,00
13462202OM	169,00

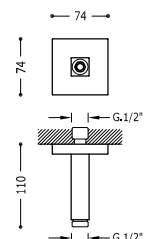

Brazo a techo

Para rociador de ducha. Longitud: 110 mm.

13452202	67,00
13452202NM	104,00
13452202BM	104,00
13452202AC	104,00
13452202OR	147,00
13452202OM	147,00

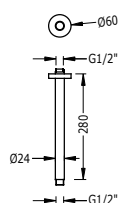

Brazo a techo

Para rociador de ducha. Longitud: 280 mm.

13462102	60,00
13462102NM	93,00
13462102BM	93,00
13462102AC	93,00
13462102KMB	93,00
13462102OR	132,00
13462102OM	132,00
13462102OP	132,00
13462102OPM	132,00

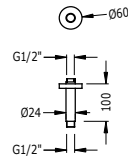

Brazo a techo

Para rociador de ducha. Longitud: 100 mm.

13452102	50,00
13452102NM	78,00
13452102BM	78,00
13452102AC	78,00
13452102KM	78,00
13452102KMB	78,00
13452102OR	110,00
13452102OM	110,00
13452102OP	110,00
13452102OPM	110,00

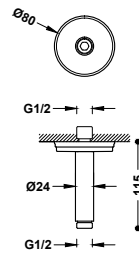

Brazo a techo Clasic

Para rociador de ducha. Longitud: 115 mm.

29933702	60,00
29933702AC	93,00
29933702OR	132,00
29933702LV	87,00
29933702LM	87,00

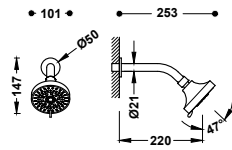

Brazo a pared con rociador de ducha orientable

Rociador de ducha orientable: Ø 100 mm. 3 tipos de chorro.

13463304	44,00
----------	-------

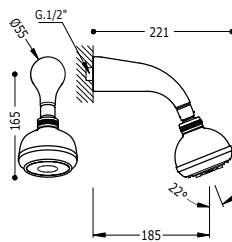
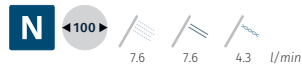

Brazo a pared con rociador de ducha orientable

Rociador de ducha orientable: Ø 93 mm. 3 tipos de chorro.

134818	86,00
--------	-------

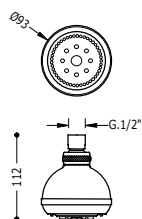

Rociador de ducha

Rótula orientable. Dimensiones: Ø 93 mm. 3 tipos de chorro.

913481810	26,00
-----------	-------

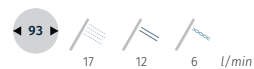

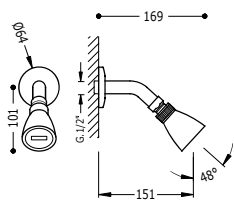

Brazo a pared con rociador de ducha orientable

134738

56,00

Rociador de ducha orientable: Ø 54 mm.

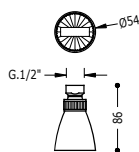

Rociador de ducha

913473810

36,00

Rótula orientable. Dimensiones: Ø 54 mm.

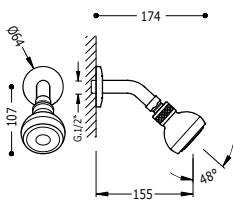

Brazo a pared con rociador de ducha orientable

134808

39,00

Rociador de ducha orientable: Ø 70 mm. Boquillas anticálcarea.

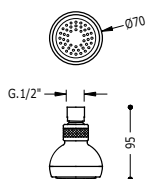

Rociador de ducha

913480810

19,00

Rótula orientable. Dimensiones: Ø 70 mm. Boquillas anticálcarea.

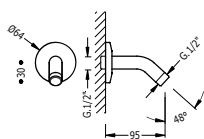

Brazo a pared para rociador de ducha

13473850

20,00

Para rociador de ducha. Longitud: 95 mm.

DUCHAS DE MANO

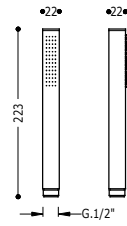

Ducha de mano Quadro

Material: Latón. Boquillas anticalcáreas.



00663901	46,00
00663901NM	71,00
00663901BM	71,00
00663901AC	71,00
00663901KM	71,00
00663901KMB	71,00
00663901OR	101,00
00663901OM	101,00
00663901OP	101,00
00663901OPM	101,00

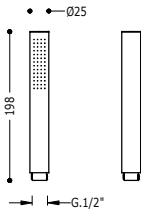

Ducha de mano Tub

Material: Latón. Boquillas anticalcáreas.

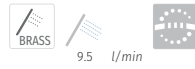

03411601	41,00
03411601NM	64,00
03411601BM	64,00
03411601AC	64,00
03411601KM	64,00
03411601KMB	64,00
03411601OR	90,00
03411601OM	90,00
03411601OP	90,00
03411601OPM	90,00

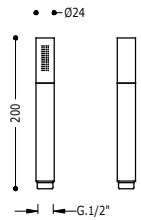

Ducha de mano

Material: Latón.

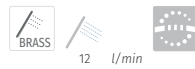

913412380	31,00
-----------	-------

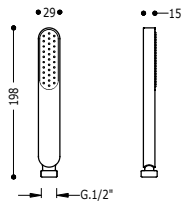

Ducha de mano Oval

Boquillas anticalcáreas.



03463901	39,00
03463901NM	60,00
03463901BM	60,00
03463901AC	60,00
03463901KMB	60,00
03463901OR	86,00
03463901OM	86,00
03463901OP	86,00
03463901OPM	86,00

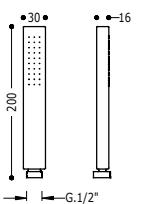

Ducha de mano Prisma

Boquillas anticalcáreas.

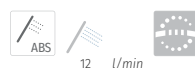

29963108	21,00
----------	-------



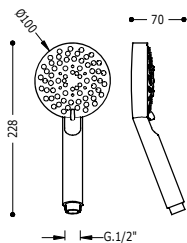

Ducha de mano L100+

Dimensiones: Ø 100 mm. 5 tipos de chorro. Boquillas anticalcáreas.

134748

48,00

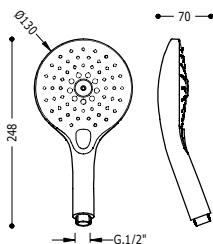
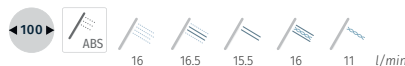

Ducha de mano D130+

Con 3 tipos de chorro. Medida: Ø 130 mm. Boquillas anticalcáreas.

29974904

45,00

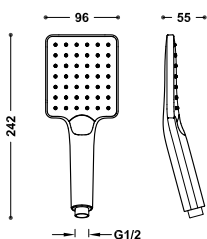

Ducha de mano Eco-drop

Con 3 tipos de chorro. Medida: 96x110 mm. Boquillas anticalcáreas.

29963113

43,00

29963113NM

67,00

29963113BM

67,00

29963113AC

67,00

29963113KM

67,00

29963113KMB

67,00

29963113OR

95,00

29963113OM

95,00

29963113OP

95,00

29963113OPM

95,00

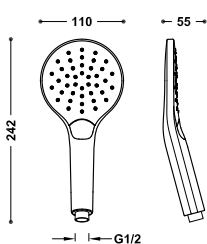

Ducha de mano Eco-drop

Con 3 tipos de chorro. Medida: Ø 110 mm. Boquillas anticalcáreas.

29963112

41,00

29963112NM

64,00

29963112BM

64,00

29963112AC

64,00

29963112KM

64,00

29963112KMB

64,00

29963112OR

90,00

29963112OM

90,00

29963112OP

90,00

29963112OPM

90,00

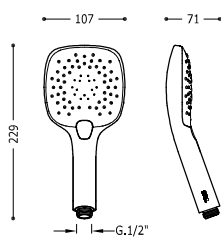

Ducha de mano Aqua-push

Con 3 tipos de chorro. Medida: 107x107 mm. Boquillas anticalcáreas.

29974906

39,00

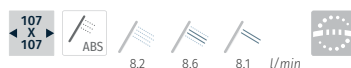

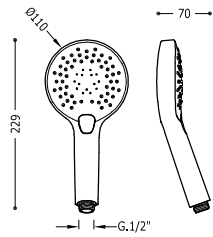

Ducha de mano Aqua-push

29974905

35,00

Con 3 tipos de chorro. Medida: Ø 110 mm. Boquillas anticalcáreas.

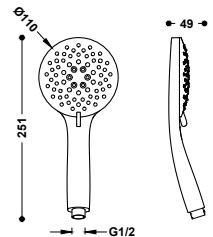
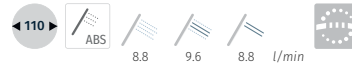

Ducha de mano R110+

29974901

33,00

Con 5 tipos de chorro. Medida: Ø 110 mm. Boquillas anticalcáreas.

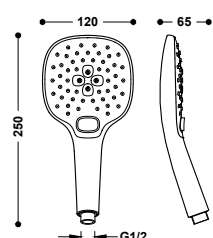
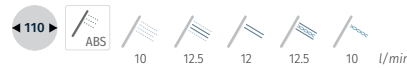

Ducha de mano Essence

29963111

26,00

Dimensiones: 120x120 mm. 3 tipos de chorro. Boquillas anticalcáreas.

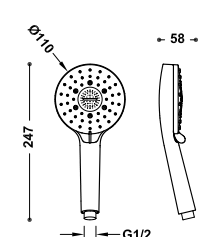
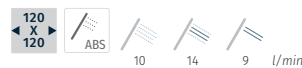

Ducha de mano Autoclean

29963115

25,00

Dimensiones: Ø 110 mm. 5 tipos de chorro. Boquillas anticalcáreas autolimpiables.



BOQUILLAS ANTICALCÁREAS AUTOLIMPIABLES

Al cambiar de función moviendo la palanca, las pásas limpian cada boquilla para que no quede cal incrustada.

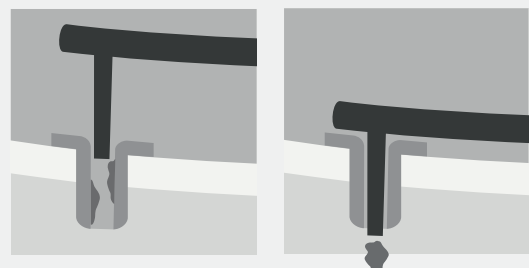

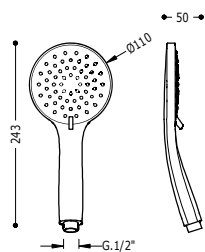

Ducha de mano D110+

Dimensiones: Ø 110 mm. 5 tipos de chorro. Boquillas anticalcáreas.

29963106

25,00

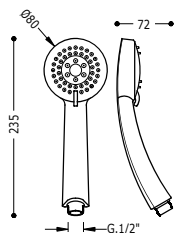
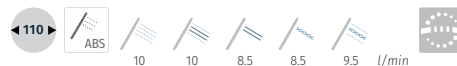

Ducha de mano D80+

Dimensiones: Ø 80 mm. 2 tipos de chorro. Boquillas anticalcáreas.

134627

17,00

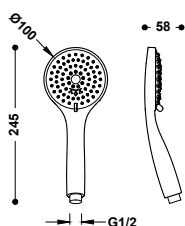

Ducha de mano D100+

Dimensiones: Ø 100 mm. 3 tipos de chorro. Boquillas anticalcáreas.

29963114

16,00

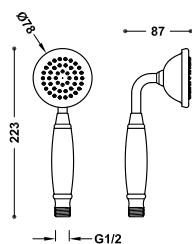
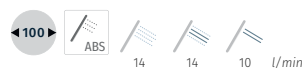

Ducha de mano Clasic

Mango cerámico. Dimensiones: Ø 78 mm. Material: Latón. Boquillas anticalcáreas.

29963109

58,00

29963109AC

90,00

29963109OR

145,00

29963109LV

84,00

29963109LM

84,00

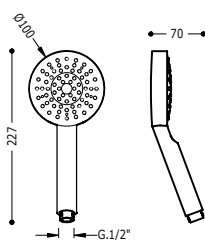

Ducha de mano L100

Dimensiones: Ø 100 mm.

29974802

30,00



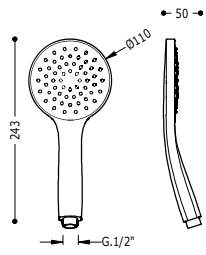

Ducha de mano D110

Dimensiones: Ø 110 mm. Boquillas anticalcáreas.

29963105

28,00

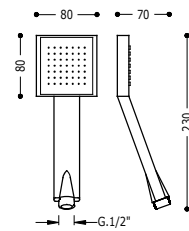

Ducha de mano Q80

Medida: 80x80 mm. Boquillas anticalcáreas.

134612

18,00

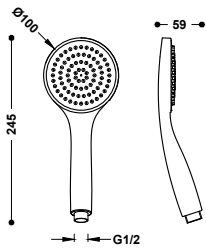

Ducha de mano D100

Dimensiones: Ø 100 mm. Boquillas anticalcáreas.

29963110

16,00

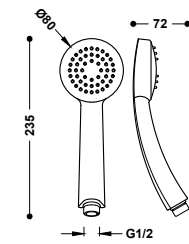

Ducha de mano D80

Dimensiones: Ø 80 mm. Boquillas anticalcáreas.

134617

15,00

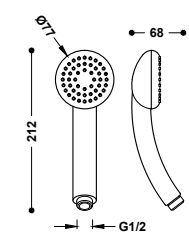

Ducha de mano Basic

Dimensiones: Ø 77 mm. Boquillas anticalcáreas.

9134725

12,00



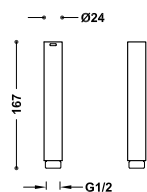

Ducha de mano para grifo de inodoro

■ 29912390

46,00

Con record limitador: 5 l/min. Para ref.: 00612301, 00612302, 134122, 134123, 181222, 181223, 20522201, 20522301, 28112301.

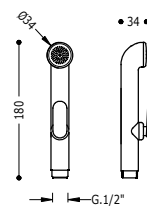

Ducha de mano con cierre para grifo de inodoro

■ 29911351

16,00

Con record limitador: 8 l/min. Para ref.: 181113, 29995001.

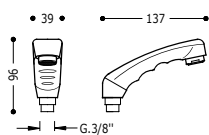

Ducha de mano para grifo de peluquería

■ 9134450

20,00



FLEXOS

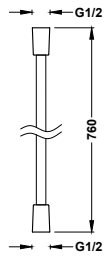

Flexo satinado

Long.: 0,76 m. Diámetro: Ø 14,5 mm. Giratorio antitorsión.

913460910 21,00

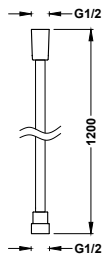

Flexo satinado

Long.: 1,20 m. Diámetro: Ø 14,5 mm. Giratorio antitorsión.

- 913460912 23,00
- 913460912NM 35,00
- 913460912BM 35,00
- 913460912AC 35,00
- 913460912KM 35,00
- 913460912KMB 35,00
- 913460912OR 51,00
- 913460912OM 51,00
- 913460912OP 51,00
- 913460912OPM 51,00

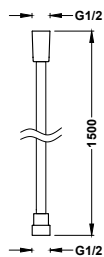

Flexo satinado

Long.: 1,50 m. Diámetro: Ø 14,5 mm. Giratorio antitorsión.

- 913460915 23,00
- 913460915NM 35,00
- 913460915BM 35,00
- 913460915AC 35,00
- 913460915KM 35,00
- 913460915KMB 35,00
- 913460915OR 51,00
- 913460915OM 51,00
- 913460915OP 51,00
- 913460915OPM 51,00

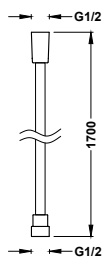

Flexo satinado

Long.: 1,70 m. Diámetro: Ø 14,5 mm. Giratorio antitorsión.

- 9134609 24,00
- 9134609NM 36,00
- 9134609BM 36,00
- 9134609AC 36,00
- 9134609KM 36,00
- 9134609KMB 36,00
- 9134609OR 52,00
- 9134609OM 52,00
- 9134609OP 52,00
- 9134609OPM 52,00

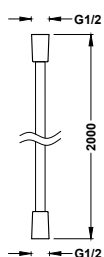

Flexo satinado

Long.: 2,00 m. Diámetro: Ø 14,5 mm. Giratorio antitorsión.

913460920 24,00



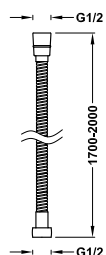
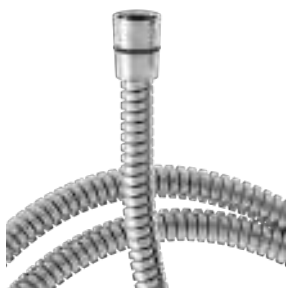

Flexo metálico extensible

Long: 1,70 m. Diámetro: Ø 14 mm. Material: Acero inoxidable.

9134630

15,00

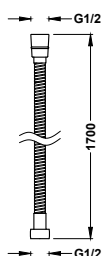
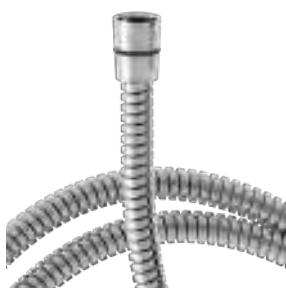

Flexo metálico reforzado

Long: 1,70 m. Tuerca cónica con junta tórica y arandela prisionera en racor. Garantía de diez años.

9134828

18,00

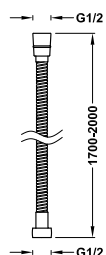
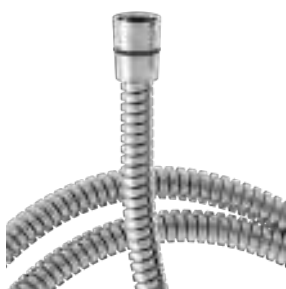

Flexo metálico reforzado y extensible

Long: 1,70 m. Tuerca cónica con junta tórica y arandela prisionera en racor. Garantía de diez años.

913483080

20,00

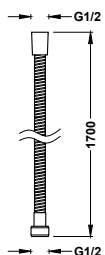

Flexo metálico

Long: 1,70 m.

9134830053

82,00

9134830054

164,00

9134830051

82,00

913483005LM

82,00

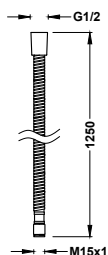

Flexo metálico reforzado

Long: 1,25 m. Diámetro: Ø 12 mm. Para ref: 03044401, 03944401, 06944401.

9134867

33,00

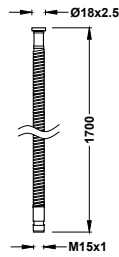

Flexo metálico

9134712

29,00

Long: 1,70 m. Diámetro: Ø 12 mm. Para ref: 114444, 162437, 162438, 181437, 181438, 56243703.

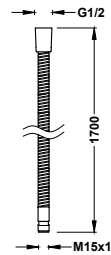

Flexo metálico reforzado

9134881

33,00

Long: 1,70 m. Tuerca cónica con junta tórica y arandela prisionera en racor. Garantía de diez años. Para ref: 006161xx, 06116101, 062161xx, 08115001, 08116103, 09286570, 10616102, 10716102, 162161, 163145, 169145, 200162xx, 202161xx, 20266102, 203161xx, 205161xx, 20725207, 20735207, 211161xx, 26215001.

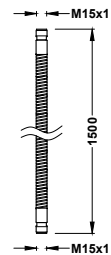

Flexo metálico

9134731

33,00

Long: 1,50 m. Para ref: 24214501, 24214601, 24214602.

9134731051

82,00

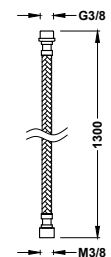

Flexo para ducha de peluquería

9134887

35,00

Long: 1,30 m. Para ref: 72450. Material: Nylon negro.



BARRAS DESLIZANTES

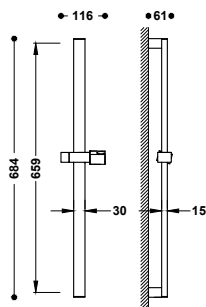

Barra deslizante para ducha

134516

68,00

Barra de ducha de latón: long. 659 mm. Soporte deslizante y orientable para ducha de mano.

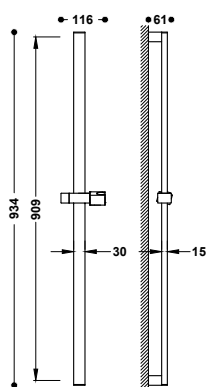

Barra deslizante para ducha

134517

100,00

Barra de ducha de latón: long. 909 mm. Soporte deslizante y orientable para ducha de mano.

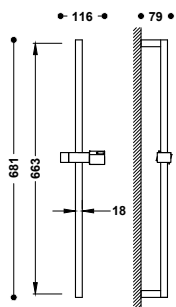

Barra deslizante para ducha

107922

68,00

Barra de ducha de latón: long. 663 mm. Soporte deslizante y orientable para ducha de mano.

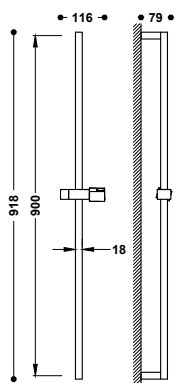

Barra deslizante para ducha

134520

100,00

Barra de ducha de latón: long. 900 mm. Soporte deslizante y orientable para ducha de mano.

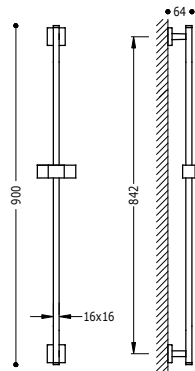

Barra deslizante para ducha

Barra de ducha de latón: long. 842 mm. Soporte deslizante y orientable para ducha de mano.

107935

139,00

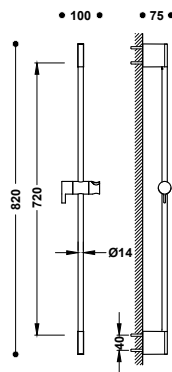

Barra deslizante para ducha

Barra de ducha: long. 820 mm y Ø 14 mm. Soporte deslizante y orientable para ducha de mano.

03463701

86,00

03463701NM

133,00

03463701BM

133,00

03463701AC

133,00

03463701KMB

133,00 **N**

03463701OM

189,00 **N**

03463701OPM

189,00 **N**

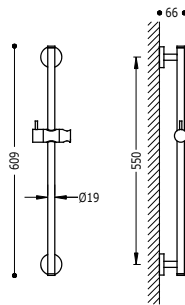

Barra deslizante para ducha

Barra de ducha: long. 550 mm y Ø 19 mm. Soporte deslizante y orientable para ducha de mano.

134618

52,00

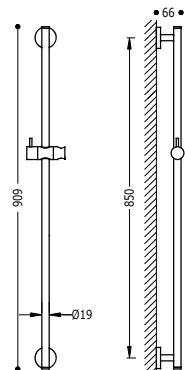

Barra deslizante para ducha

Barra de ducha: long. 850 mm y Ø 19 mm. Soporte deslizante y orientable para ducha de mano.

134619

70,00

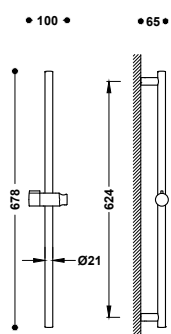

Barra deslizante para ducha

03463702

64,00

Barra de ducha: long. 624 mm y Ø 20.6 mm. Soporte deslizante y orientable para ducha de mano.

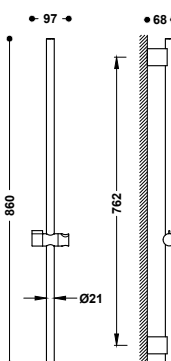

Barra deslizante para ducha

03463708

95,00

Barra de ducha: long. 762 mm y Ø 20,6 mm. Soporte deslizante y orientable para ducha de mano.

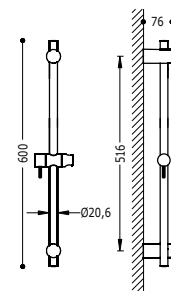

Barra deslizante para ducha

161835

38,00

Barra de ducha con fijaciones regulables en altura: long. 516 mm y Ø 20,6 mm. Soporte deslizante y orientable para ducha de mano.

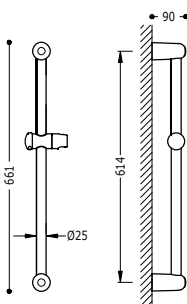

Barra deslizante para ducha

143835

25,00

Barra de ducha: long. 614 mm y Ø 25 mm. Soporte deslizante y orientable para ducha de mano.

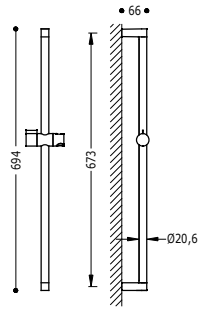

Barra deslizante para ducha

03463706

33,00

Barra de ducha: long. 673 mm y \varnothing 20,6 mm. Soporte deslizante y orientable para ducha de mano.

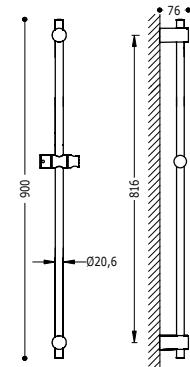

Barra deslizante para ducha

161838

59,00

Barra de ducha con fijaciones regulables en altura: long. 816 mm y \varnothing 20,6 mm. Soporte deslizante y orientable para ducha de mano.

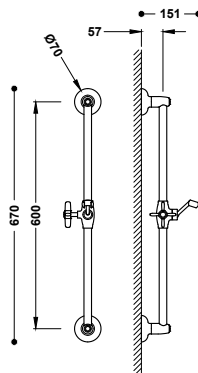

Barra deslizante para ducha

24273201

216,00

24273201AC

335,00

24273201LV

313,00

24273201LM

313,00

Barra de ducha: 600 mm y \varnothing 20,6 mm. Soporte deslizante y orientable para ducha de mano.

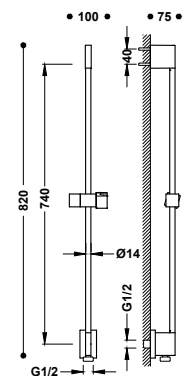

Barra deslizante para ducha con toma de agua a pared

03493299

149,00

03493299NM

231,00

03493299BM

231,00

03493299AC

231,00

03493299KMB

231,00 **N**

03493299OM

328,00 **N**

03493299OPM

328,00 **N**

Barra de ducha: 740 mm y \varnothing 14 mm. Soporte deslizante y orientable para ducha de mano.

R1/2" G



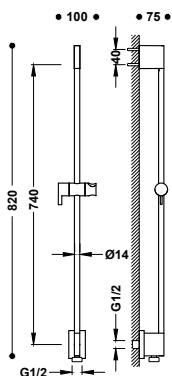

Barra deslizante para ducha con toma de agua a pared

Barra de ducha: 740 mm y Ø 14 mm. Soporte deslizante y orientable para ducha de mano.

03493199	142,00
03493199NM	220,00
03493199BM	220,00
03493199AC	220,00
03493199KMB	220,00 N
03493199OM	312,00 N
03493199OPM	312,00 N

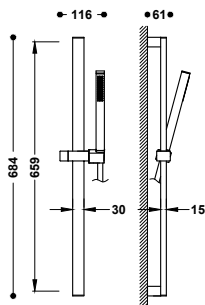

Conjunto de barra de ducha

Barra de ducha de latón: long. 659 mm. Soporte deslizante y orientable para ducha de mano. Ducha de mano anticalcárea de latón. Flexo satinado.

03452602	118,00
----------	--------

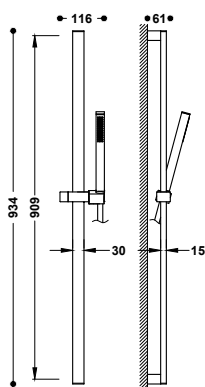

Conjunto de barra de ducha

Barra de ducha de latón: long. 909 mm. Soporte deslizante y orientable para ducha de mano. Ducha de mano anticalcárea de latón. Flexo satinado.

03452702	155,00
----------	--------

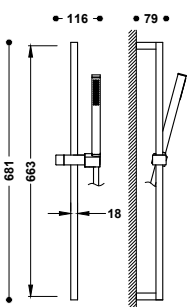

Conjunto de barra de ducha

Barra de ducha de latón: long. 663 mm. Soporte deslizante y orientable para ducha de mano. Ducha de mano anticalcárea de latón. Flexo satinado.

03433603	118,00
----------	--------



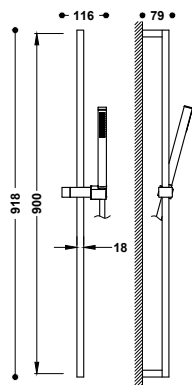

Conjunto de barra de ducha

03433604

155,00

Barra de ducha de latón: long. 900 mm. Soporte deslizante y orientable para ducha de mano. Ducha de mano anticalcárea de latón. Flexo satinado.

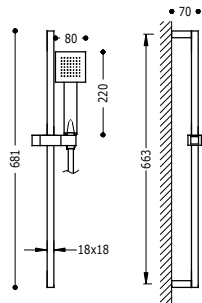

Conjunto de barra de ducha

134512

105,00

Barra de ducha de latón: long. 663 mm. Soporte deslizante y orientable para ducha de mano. Ducha de mano anticalcárea. Flexo satinado.

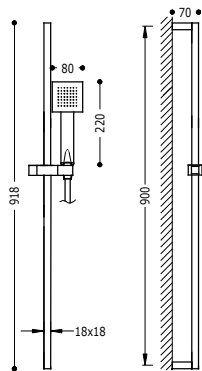

Conjunto de barra de ducha

134522

141,00

Barra de ducha de latón: long. 900 mm. Soporte deslizante y orientable para ducha de mano. Ducha de mano anticalcárea. Flexo satinado.

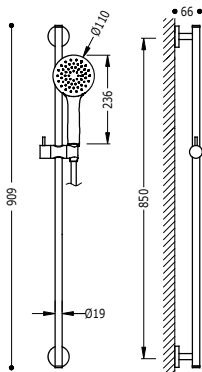

Conjunto de barra de ducha

06192801

115,00

Barra de ducha: long. 850 mm y Ø 19 mm. Soporte deslizante y orientable para ducha de mano. Ducha de mano anticalcárea. Flexo satinado.



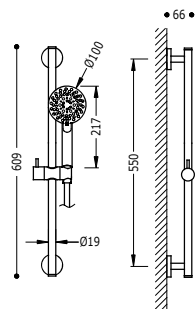

Conjunto de barra de ducha

■ 134628

122,00

Barra de ducha: long. 550 mm y Ø 19 mm. Soporte deslizante y orientable para ducha de mano. Ducha de mano anticalcárea: Ø 100 mm. (5 tipos de chorro). Flexo satinado.

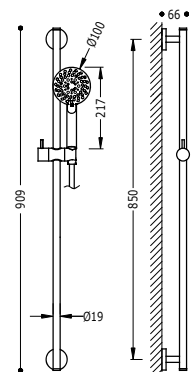
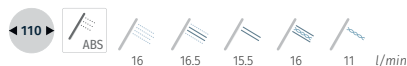

Conjunto de barra de ducha

■ 134629

137,00

Barra de ducha: long. 850 mm y Ø 19 mm. Soporte deslizante y orientable para ducha de mano. Ducha de mano anticalcárea: Ø 100 mm. (5 tipos de chorro). Flexo satinado.

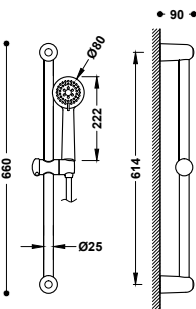
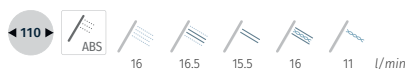

Conjunto de barra de ducha

■ 143836

63,00

Barra de ducha: long. 614 mm y Ø 25 mm. Soporte deslizante y orientable para ducha de mano. Ducha de mano anticalcárea: Ø 80 mm. (2 tipos de chorro). Flexo satinado.

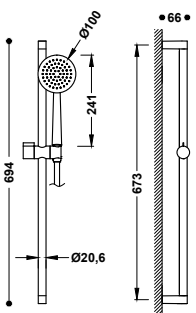

Conjunto de barra de ducha

■ 03463709

67,00

■ 03463709NM

104,00

Barra de ducha: long. 673 mm y Ø 20,6 mm. Soporte deslizante y orientable para ducha de mano. Ducha de mano anticalcárea. Flexo satinado.



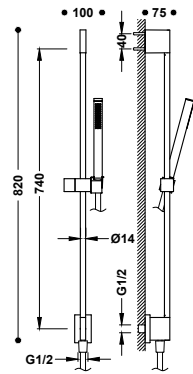

Conjunto de barra de ducha con toma de agua a pared

Barra de ducha: 820 mm y Ø 14 mm. Soporte deslizante y orientable para ducha de mano. Ducha de mano anticalcárea de latón. Flexo satinado.

03493201	204,00
03493201NM	316,00
03493201BM	316,00
03493201AC	316,00

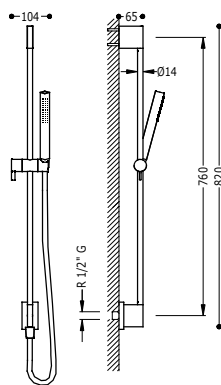

Conjunto de barra de ducha con toma de agua a pared

Barra de ducha: 760 mm y Ø 14 mm. Soporte deslizante y orientable para ducha de mano. Ducha de mano anticalcárea de latón. Flexo satinado.

03493101	197,00
03493101NM	305,00
03493101BM	305,00
03493101AC	305,00

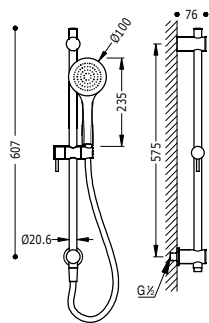

Conjunto de barra de ducha con toma de agua a pared

Soporte con toma de agua a pared. Barra de ducha: long. 575 mm y Ø 20,6 mm. Soporte deslizante y orientable para ducha de mano. Ducha de mano anticalcárea. Flexo satinado.

06193103	131,00
----------	--------

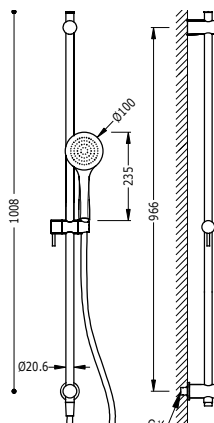

Conjunto de barra de ducha con toma de agua a pared

Soporte con toma de agua a pared. Barra de ducha: long. 966 mm y Ø 20,6 mm. Soporte deslizante y orientable para ducha de mano. Ducha de mano anticalcárea. Flexo satinado.

06193105	151,00
----------	--------



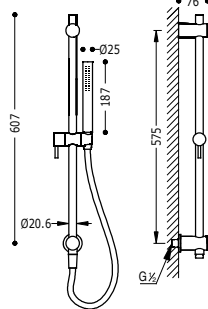

Conjunto de barra de ducha con toma de agua a pared

06193102

134,00

Soporte con toma de agua a pared. Barra de ducha: long. 575 mm y Ø 20,6 mm. Soporte deslizante y orientable para ducha de mano. Ducha de mano anticalcárea de latón. Flexo satinado.

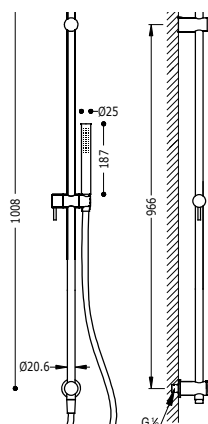

Conjunto de barra de ducha con toma de agua a pared

06193104

155,00

Soporte con toma de agua a pared. Barra de ducha: long. 966 mm y Ø 20,6 mm. Soporte deslizante y orientable para ducha de mano. Ducha de mano anticalcárea de latón. Flexo satinado.

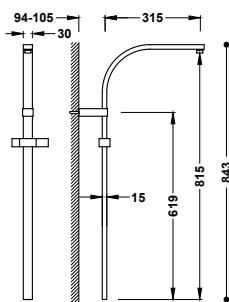

Barra de ducha adaptable a grifo termostático mural con conexión compatible

A completar con el resto de elementos de ducha.

- 03463506 144,00
- 03463506NM 223,00
- 03463506BM 223,00
- 03463506AC 223,00
- 03463506KMB 223,00
- 03463506OM 317,00
- 03463506OPM 317,00

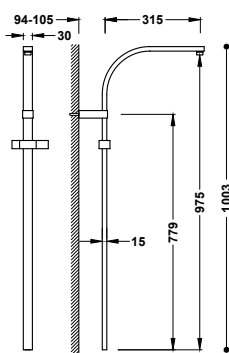

Barra de ducha larga adaptable a grifo termostático mural con conexión compatible

A completar con el resto de elementos de ducha.

- 03463505 154,00
- 03463505NM 239,00
- 03463505BM 239,00
- 03463505AC 239,00
- 03463505KMB 239,00
- 03463505OM 339,00
- 03463505OPM 339,00

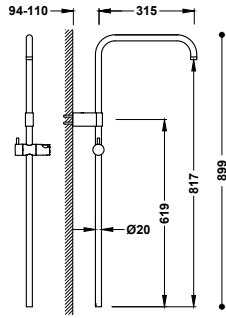

Barra de ducha adaptable a grifo termostático mural con conexión compatible

A completar con el resto de elementos de ducha.

■ 03463502	104,00
■ 03463502NM	161,00
■ 03463502BM	161,00
■ 03463502AC	161,00
■ 03463502KMB	161,00
■ 03463502OM	229,00
■ 03463502OPM	229,00

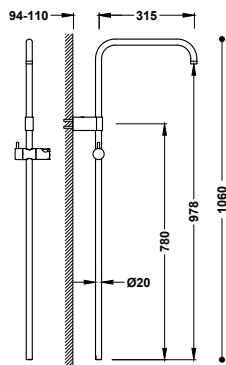

Barra de ducha larga adaptable a grifo termostático mural con conexión compatible

A completar con el resto de elementos de ducha.

■ 03463501	114,00
■ 03463501NM	177,00
■ 03463501BM	177,00
■ 03463501AC	177,00
■ 03463501KMB	177,00
■ 03463501OM	251,00
■ 03463501OPM	251,00

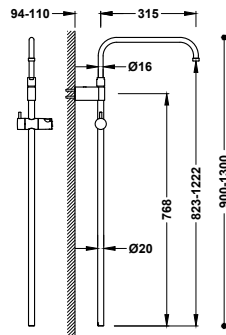

Barra de ducha telescópica adaptable a grifo termostático mural con conexión compatible

A completar con el resto de elementos de ducha.

■ 03464501	145,00
■ 03464501NM	225,00
■ 03464501BM	225,00
■ 03464501AC	225,00
■ 03464501KMB	225,00
■ 03464501OM	319,00
■ 03464501OPM	319,00

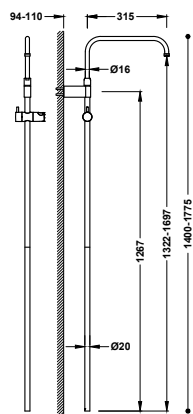

Barra de ducha telescópica adaptable a grifo termostático mural con conexión compatible

A completar con el resto de elementos de ducha.

■ 03464502	160,00
------------	--------



KITS DE DUCHA

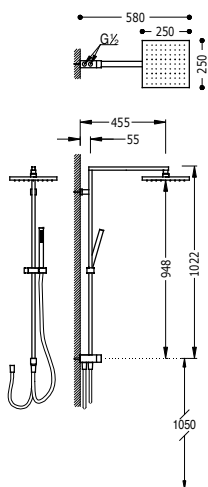

Conjunto de ducha adaptable a cualquier grifo

107476

378,00

- Con inversor integrado en la barra de ducha.
- Rociador de ducha orientable de acero inoxidable: 250x250 mm.
- Soporte deslizante y orientable para ducha de mano.
- Ducha de mano anticalcárea de latón.
- Flexo satinado.

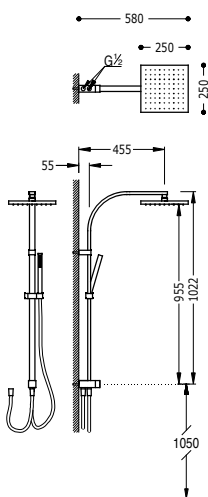

Conjunto de ducha adaptable a cualquier grifo

107926

375,00

- Con inversor integrado en la barra de ducha.
- Rociador de ducha orientable de acero inoxidable: 250x250 mm.
- Soporte deslizante y orientable para ducha de mano.
- Ducha de mano anticalcárea de latón.
- Flexo satinado.

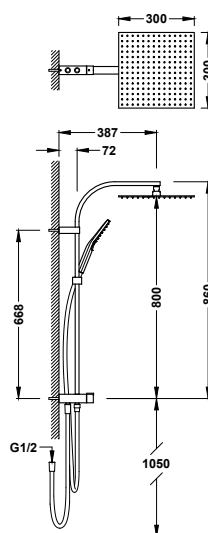

Conjunto de ducha adaptable a cualquier grifo

19063504

349,00

19063504NM

540,00

19063504BM

540,00

19063504AC

540,00

19063504OM

767,00

- Con inversor integrado en la barra de ducha.
- Rociador de ducha orientable de acero inoxidable: 300x300 mm.
- Soporte deslizante y orientable para ducha de mano.
- Ducha de mano anticalcárea: 96x110 mm. (3 tipos de chorro).
- Flexo satinado.



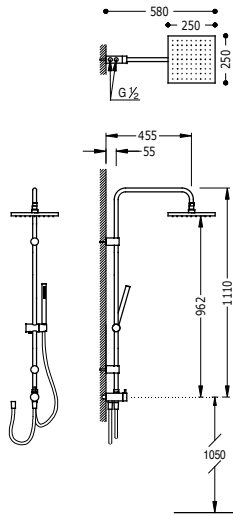

Conjunto de ducha adaptable a cualquier grifo

- Con inversor integrado en la barra de ducha.
- Rociador de ducha orientable de acero inoxidable: 250x250 mm.
- Soporte deslizante y orientable para ducha de mano.
- Ducha de mano anticalcárea de latón.
- Flexo satinado.

06163506

336,00

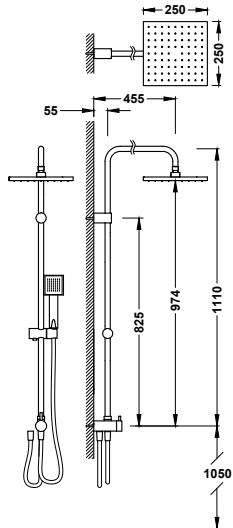

Conjunto de ducha adaptable a cualquier grifo

- Con inversor integrado en la barra de ducha.
- Rociador de ducha orientable: 250x250 mm.
- Soporte deslizante y orientable para ducha de mano.
- Ducha de mano anticalcárea: 80x80 mm.
- Flexo metálico reforzado.

20047501

252,00

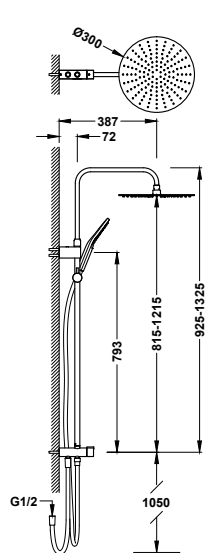
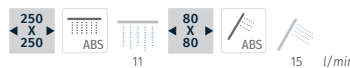

Conjunto de ducha adaptable a cualquier grifo

- Con inversor integrado en la barra de ducha.
- Rociador de ducha orientable de acero inoxidable: Ø 300 mm.
- Soporte deslizante y orientable para ducha de mano.
- Ducha de mano anticalcárea: Ø 110 mm. (3 tipos de chorro).
- Flexo satinado.

19063502

362,00

19063502NM 561,00

19063502BM 561,00

19063502KMB 561,00

19063502OM 797,00

19063502OPM 797,00



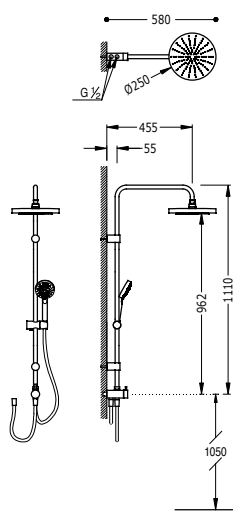

Conjunto de ducha adaptable a cualquier grifo

161214

315,00

- Con inversor integrado en la barra de ducha.
- Rociador de ducha orientable de acero inoxidable: Ø 250 mm.
- Soporte deslizante y orientable para ducha de mano.
- Ducha de mano anticalcárea: Ø 100 mm. (5 tipos de chorro).
- Flexo satinado.

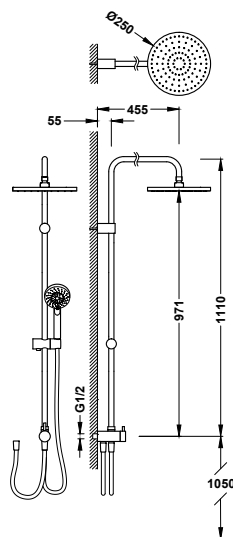

Conjunto de ducha adaptable a cualquier grifo

161475

257,00

- Con inversor integrado en la barra de ducha.
- Rociador de ducha orientable de acero inoxidable: Ø 250 mm.
- Soporte deslizante y orientable para ducha de mano.
- Ducha de mano anticalcárea: Ø 100 mm. (5 tipos de chorro).
- Flexo satinado.

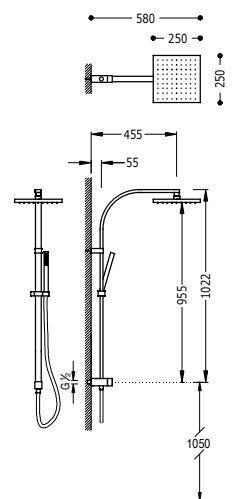

Conjunto de barra de ducha sin grifo con toma de agua y rociador

107131

373,00

- Con inversor integrado en la barra de ducha.
- Rociador de ducha orientable de acero inoxidable: 250x250 mm.
- Soporte deslizante y orientable para ducha de mano.
- Ducha de mano anticalcárea de latón.
- Flexo satinado.



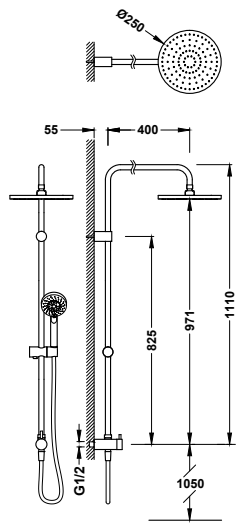

Conjunto de barra de ducha sin grifo con toma de agua y rociador

06163505

255,00

- Con inversor integrado en la barra de ducha.
- Rociador de ducha orientable de acero inoxidable: Ø 250 mm.
- Soporte deslizante y orientable para ducha de mano.
- Ducha de mano anticalcárea: Ø 100 mm. (5 tipos de chorro).
- Flexo satinado.

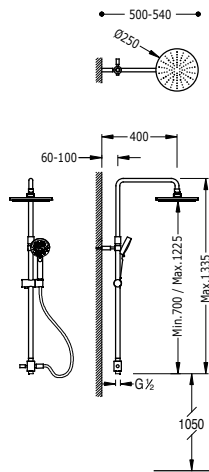
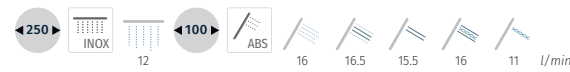

Conjunto de barra de ducha sin grifo con toma de agua y rociador

161213

342,00

- Con inversor integrado en la barra de ducha.
- Barra de ducha telescópica.
- Rociador de ducha orientable de acero inoxidable: Ø 250 mm.
- Soporte deslizante y orientable para ducha de mano.
- Ducha de mano anticalcárea: Ø 100 mm. (5 tipos de chorro).
- Flexo satinado.

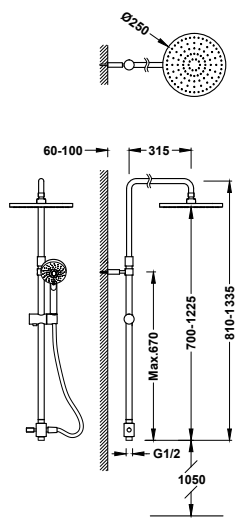

Conjunto de barra de ducha sin grifo con toma de agua y rociador

06163509

310,00

- Con inversor integrado en la barra de ducha.
- Barra de ducha telescópica.
- Rociador de ducha orientable de acero inoxidable: Ø 250 mm.
- Soporte deslizante y orientable para ducha de mano.
- Ducha de mano anticalcárea: Ø 100 mm.
- Flexo satinado.



SOPORTES ORIENTABLES

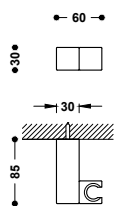

Soporte orientable para ducha de mano

Material: Latón.

107839	31,00
107839NM	48,00
107839BM	48,00
50783903	48,00
107839OR	68,00
107839OM	68,00

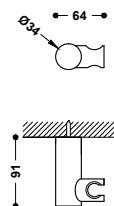

Soporte orientable para ducha de mano

Material: Latón.

161839	29,00
06183901NM	45,00
06183901BM	45,00
06183901AC	45,00
06183901KM	45,00
06183901KMB	45,00
06183901OR	64,00
06183901OM	64,00
06183901OPM	64,00

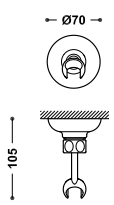

Soporte orientable para ducha de mano

Material: Latón.

29963910	40,00
29963910AC	62,00
29963910OR	88,00
29963910LV	58,00
29963910LM	58,00

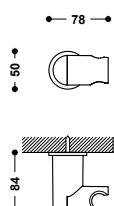

Soporte orientable para ducha de mano

29963901	10,00
----------	-------

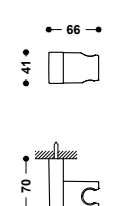

Soporte orientable para ducha de mano

29963928	7,00
----------	------

Soporte fijo para ducha de mano

9134841

10,00



Soporte articulado con 3 posiciones para ducha de mano

134215023

7,00

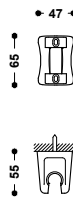

SOPORTES CON TOMA A PARED

Soporte fijo con toma de agua para ducha de mano y flexo

Válvula antirretorno. Con protección contra golpes. Material: Latón.

20718221

75,00

20718221NM

116,00

20718221BM

116,00

20718221AC

116,00

20718221OR

165,00

20718221OM

165,00

20718221OPM

165,00

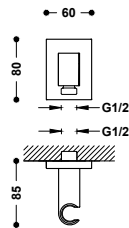

N

Soporte fijo con toma de agua para ducha de mano y flexo

Válvula antirretorno. Con protección contra golpes.

20218221

48,00

20218221NM

74,00

20218221BM

74,00

20218221AC

74,00

20218221OR

106,00

20218221OM

106,00

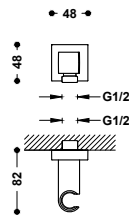

N

Soporte fijo con toma de agua para ducha de mano y flexo

Válvula antirretorno. Con protección contra golpes.

21118221

45,00

21118221NM

70,00

21118221BM

70,00

21118221AC

70,00

21118221KM

70,00

21118221KMB

70,00

21118221OR

99,00

21118221OM

99,00

21118221OP

99,00

21118221OPM

99,00

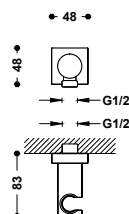

N







Soporte fijo con toma de agua para ducha de mano y flexo
 Válvula antirretorno. Con protección contra golpes.

■	26118221	42,00
■	26118221NM	65,00
■	26118221BM	65,00
■	26118221AC	65,00
■	26118221KM	65,00
■	26118221KMB	65,00
■	26118221OR	92,00
■	26118221OM	92,00
■	26118221OP	92,00
■	26118221OPM	92,00

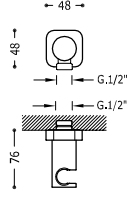

Soporte fijo con toma de agua para ducha de mano y flexo
 Válvula antirretorno.

■	20018201	55,00
■	20018201NM	85,00
■	20018201BM	85,00
■	20018201AC	85,00
■	20018201OR	120,00
■	20018201OM	120,00



Soporte fijo con toma de agua para ducha de mano y flexo
 Válvula antirretorno. Con protección contra golpes.

■	21618221	44,00
---	----------	-------







Soporte fijo con toma de agua para ducha de mano y flexo
 Válvula antirretorno. Con protección contra golpes.

■	21518221	42,00
---	----------	-------

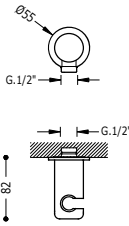

Soporte fijo con toma de agua para ducha de mano y flexo
 Válvula antirretorno.

■	02418201	50,00
---	----------	-------

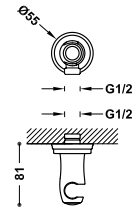

Soporte fijo con toma de agua para ducha de mano y flexo
 Con toma de agua a pared.

24218201	71,00
24218201AC	111,00
24218201OR	157,00
24218201LV	104,00
24218201LM	104,00

CODO ADAPTADOR A PARED

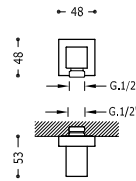

Codo con toma a pared para flexo
 Con toma de agua a pared G1/2.

00618301	63,00
00618301NM	98,00 N

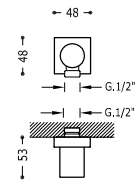

Codo con toma a pared para flexo
 Con toma de agua a pared G1/2.

06118301	35,00
----------	-------

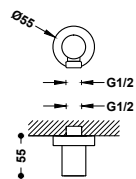

Codo con toma a pared para flexo
 Con toma de agua a pared G1/2.

20518301	35,00
20518301NM	55,00 N

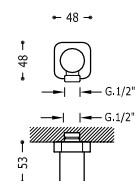

Codo con toma a pared para flexo
 Con toma de agua a pared G1/2.

20018301	35,00
----------	-------



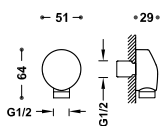

Codo con toma a pared para flexo

Con toma de agua a pared G1/2.

134757

23,00

JETS

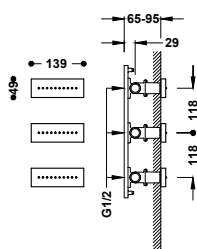

3 jets empotrados de hidromasaje

Con perfil de instalación incluido. Material: Latón. Medida: 139x49 mm.

- 29951504 693,00
- 29951504NM 1.074,00
- 29951504BM 1.074,00
- 29951504AC 1.074,00
- 29951504OR 1.525,00
- 29951504OM 1.525,00

7.9 l/min

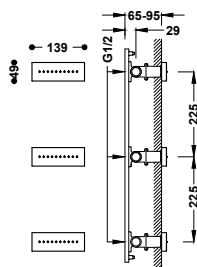

3 jets empotrados de hidromasaje

Con perfil de instalación incluido. Material: Latón. Medida: 139x49 mm.

- 29951505 709,00
- 29951505NM 1.099,00
- 29951505BM 1.099,00
- 29951505AC 1.099,00
- 29951505OR 1.559,00
- 29951505OM 1.559,00

7.9 l/min

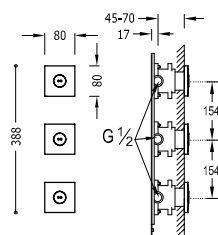

3 jets empotrados giratorios de hidromasaje

Con perfil de instalación incluido. Medida: 80x80 mm.

29951506 420,00

10 l/min

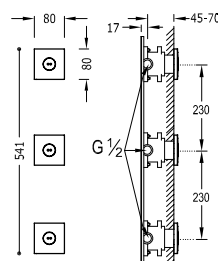

3 jets empotrados giratorios de hidromasaje

Con perfil de instalación incluido. Medida: 80x80 mm.

29951507 436,00

10 l/min

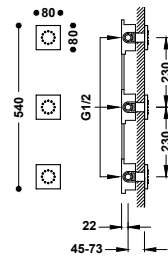

3 jets empotrados de hidromasaje

Con perfil de instalación incluido. Medida: 80x80 mm.



13451501	473,00
13451501NM	732,00
13451501BM	732,00
13451501AC	732,00
13451501KM	732,00
13451501KMB	732,00
13451501OR	1.040,00
13451501OM	1.040,00
13451501OP	1.040,00
13451501OPM	1.040,00

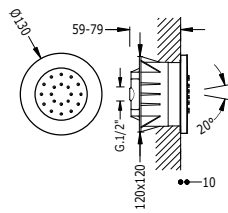

Jet empotrado de hidromasaje

Con rótula orientable. 1 tipo de chorro. Incluye un sistema anticañal, válvula antiretorno y limitador de caudal: 5 l/min.

9161515	129,00
---------	--------

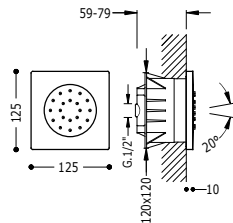

Jet empotrado de hidromasaje

Con rótula orientable. 1 tipo de chorro. Incluye un sistema anticañal, válvula antiretorno y limitador de caudal: 5 l/min.

9107515	134,00
---------	--------

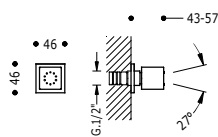

Jet de hidromasaje

Con rótula orientable. 1 tipo de chorro. Incluye un sistema anticañal, válvula antiretorno y limitador de caudal: 5 l/min. Material: Latón.

9134515	60,00
---------	-------

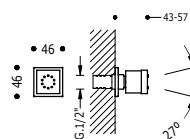

Jet de hidromasaje

Con rótula orientable. 1 tipo de chorro. Incluye un sistema anticañal, válvula antiretorno y limitador de caudal: 5 l/min. Material: Latón.

29951501	63,00
----------	-------



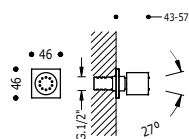

Jet de hidromasaje

■ 29951503

55,00

Con rótula orientable. 1 tipo de chorro. Incluye un sistema antical, válvula antiretorno y limitador de caudal: 5 l/min. Material: Latón.

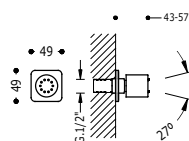

Jet de hidromasaje

■ 29951502

56,00

Con rótula orientable. 1 tipo de chorro. Incluye un sistema antical, válvula antiretorno y limitador de caudal: 5 l/min. Material: Latón.

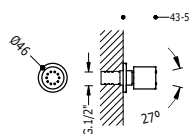

Jet de hidromasaje

■ 9134415

45,00

Con rótula orientable. 1 tipo de chorro. Incluye un sistema antical, válvula antiretorno y limitador de caudal: 5 l/min. Material: Latón.

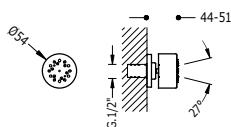

Jet de hidromasaje

■ 9134915

36,00

Con rótula orientable. 2 tipos de chorro. Caudal: 6 l/min y 4,5 l/min.

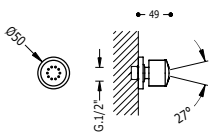

Jet de hidromasaje

■ 9134615

29,00

Con rótula orientable. 1 tipo de chorro. Caudal: 4 l/min.





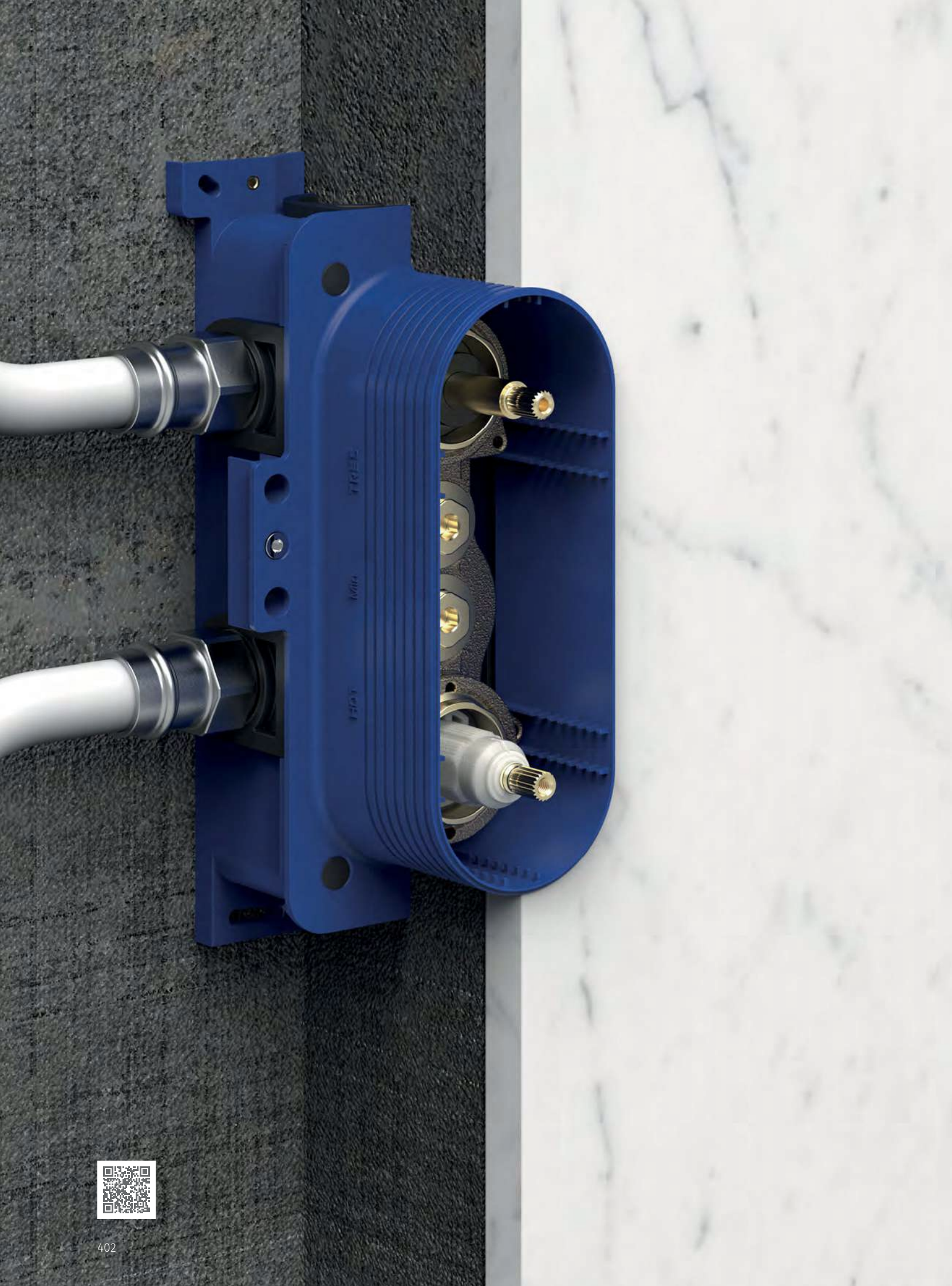

SOLUCIONES EMPOTRADAS



404 Para montaje de grifos a suelo

405 Para grifos murales de lavabo

405 Rapid-box

405 Therm-box

406 Depósitos para grifería de borde de bañera

PARA MONTAJE DE GRIFOS A SUELO

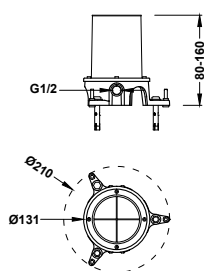

Base de empotramiento para montaje de grifos monomando a suelo

26285350

189,00

Solo parte empotrable.



Compra por separado

Puedes instalar la caja empotrada y, posteriormente, adquirir la parte vista para instalarla cuando esté todo listo. De esta manera, la planificación de la obra se simplifica y se gana en eficacia.

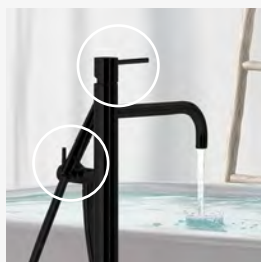

Dos reguladores independientes, uno para llenar la bañera y el otro para la ducha de mano.



El cuerpo empotrado se esconde bajo el suelo y necesita **espacio mínimo de 80 mm** y uno máximo de 160 mm.

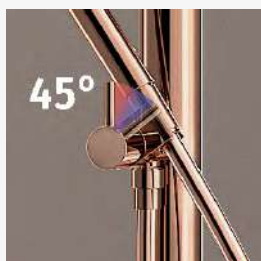

La **temperatura** del regulador de la ducha está **limitada** para evitar quemaduras. (Caudal de 7 l/min).



El cuerpo es totalmente **estanco**, evita las filtraciones de agua y protege contra la humedad.

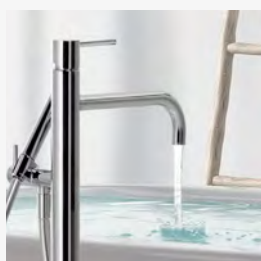

La salida para la bañera permite una temperatura más elevada para **mantener más agua caliente** dentro de la bañera. (Caudal de 22 l/min).



Una vez instalado el grifo, si no está **correctamente alineado**, hay la posibilidad de rectificar la orientación del caño en el momento de fijar el grifo.

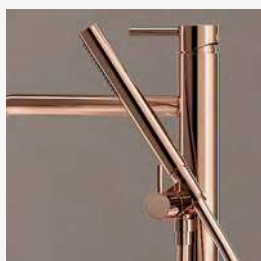

Soporte de ducha inclinado para **evitar el goteo al suelo** cuando abrimos o cerramos.



El cuerpo empotrado se puede **nivelar** durante la instalación para rectificar las irregularidades del suelo.

PARA GRIFOS MURALES DE LAVABO

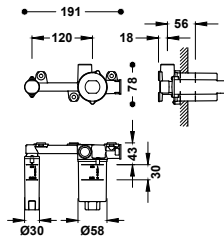

Cuerpo empotrado para grifo de lavabo

20830002

85,00

Cuerpo empotrado indivisible con amortiguadores acústicos y junta antihumedad.



RAPID-BOX

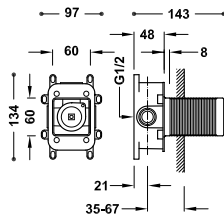

Caja empotrada de 1 vía Rapid-box con grifo monomando para ducha

20827810

80,00

Cuerpo empotrado con amortiguadores acústicos. Caja de empotrar de ABS. Junta antihumedad.

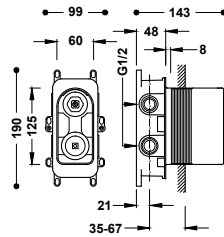

Caja empotrada de 2 vías Rapid-box con grifo monomando para ducha y bañera

20828110

90,00

Cuerpo empotrado con amortiguadores acústicos. Caja de empotrar de ABS. Junta antihumedad. Distribuidor cerámico de 2 vías.

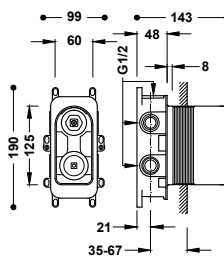

Caja empotrada de 3 vías Rapid-box con grifo monomando para ducha y bañera

20827310

95,00

Cuerpo empotrado con amortiguadores acústicos. Caja de empotrar de ABS. Junta antihumedad. Distribuidor cerámico de 3 vías.



THERM-BOX

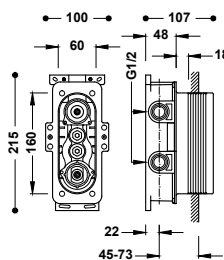

Caja empotrada de 2 vías Therm-box con grifo termostático para ducha y bañera

20785001

130,00

Cuerpo empotrado con amortiguadores acústicos. Caja de empotrar de ABS. Junta antihumedad. Distribuidor cerámico de 2 vías.



DEPÓSITOS PARA GRIFERÍA DE BORDE DE BAÑERA

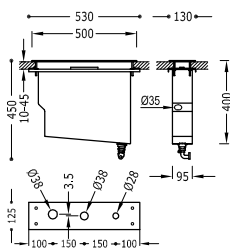

Depósito para grifería de borde de bañera

Fácil montaje superior. Sin registros. Para ref.: 20216103, 20216101.

20224501	415,00
20224501NM	643,00 N
20224501BM	643,00 N
20224501AC	643,00 N
20224501OR	912,00 N
20224501OM	912,00 N

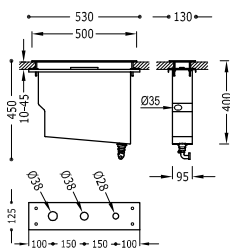

Depósito para grifería de borde de bañera

Fácil montaje superior. Sin registros. Para ref.: 006161xx, 006161xx, 205161xx.

20024501	415,00
20024501NM	643,00 N
20024501BM	643,00 N
20024501AC	518,00 N
20024501KM	643,00 N
20024501KMB	643,00 N
20024501OR	912,00 N
20024501OM	912,00 N
20024501OP	912,00 N
20024501OPM	912,00 N

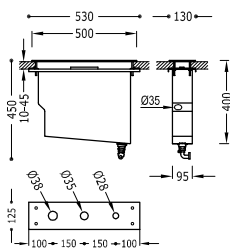

Depósito para grifería de borde de bañera

Fácil montaje superior. Sin registros. Para ref.: 10716102, 10616102.

106245	415,00
--------	--------

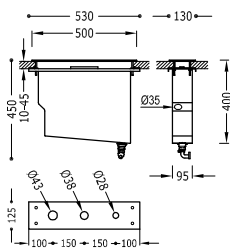

Depósito para grifería de borde de bañera

Fácil montaje superior. Sin registros. Para ref.: 200162xx, 203161xx, 062161xx.

20324501	415,00
20324501NM	643,00 N
20324501BM	643,00 N
20324501AC	643,00 N
20324501OR	912,00 N
20324501OM	912,00 N

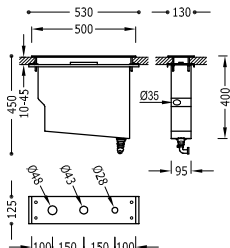

Depósito para grifería de borde de bañera

Fácil montaje superior. Sin registros. Para ref.: 26215001, 162161.

162245	415,00
--------	--------

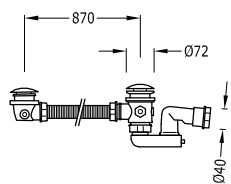

Válvula de desagüe Click-clack para bañera con rebosadero y toma de drenaje

■ 134445

100,00

Con toma de drenaje de agua para kit de depósito. Tapón Ø 72 mm.





ACCESORIOS DE BAÑO

- 410 Cuadrado
- 411 Redondo
- 412 Clásico
- 413 Packs
- 413 Dispensador de jabón
- 413 Llaves de paso



CUADRADO

Toallero
400 mm.

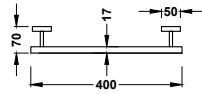

10723601	65,00
10723601NM	101,00
10723601BM	101,00
10723601AC	101,00
10723601KM	101,00
10723601KMB	101,00
10723601OR	143,00
10723601OM	143,00
10723601OP	143,00
10723601OPM	143,00

Toallero
600 mm.

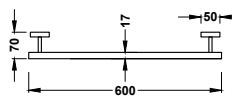

10723603	68,00
10723603NM	106,00
10723603BM	106,00
10723603AC	106,00
10723603KM	106,00
10723603KMB	106,00
10723603OR	150,00
10723603OM	150,00
10723603OP	150,00
10723603OPM	150,00

Portarrollos sin tapa

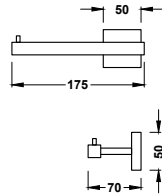

10723606	32,00
10723606NM	50,00
10723606BM	50,00
10723606AC	50,00
10723606KM	50,00
10723606KMB	50,00
10723606OR	83,00
10723606OM	83,00
10723606OP	83,00
10723606OPM	83,00

Percha

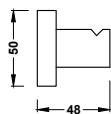

10723620	28,00
10723620NM	43,00
10723620BM	43,00
10723620AC	43,00
10723620KM	43,00
10723620KMB	43,00
10723620OR	62,00
10723620OM	62,00
10723620OP	62,00
10723620OPM	62,00

Escobillero de suelo

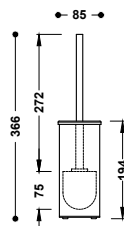

10733605	77,00
10733605NM	119,00
10733605BM	119,00
10733605AC	119,00
10733605KM	119,00
10733605KMB	119,00
10733605OR	231,00
10733605OM	231,00
10733605OP	231,00
10733605OPM	231,00



REDONDO

Toallero
480 mm.

	16123601	60,00
	16123601NM	93,00
	16123601BM	93,00
	16123601AC	93,00
	16123601KM	93,00
	16123601KMB	93,00
	16123601OR	132,00
	16123601OM	132,00
	16123601OP	132,00
	16123601OPM	132,00

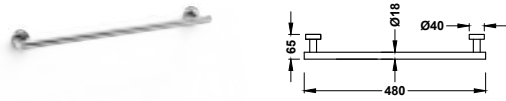



Toallero
580 mm.

	16123602	63,00
	16123602NM	98,00
	16123602BM	98,00
	16123602AC	98,00
	16123602KM	98,00
	16123602KMB	98,00
	16123602OR	139,00
	16123602OM	139,00
	16123602OP	139,00
	16123602OPM	139,00











Portarrollos sin tapa

	16123606	30,00
	16123606NM	47,00
	16123606BM	47,00
	16123606AC	47,00
	16123606KM	47,00
	16123606KMB	47,00
	16123606OR	90,00
	16123606OM	90,00
	16123606OP	90,00
	16123606OPM	90,00













Asidero para bañera
306 mm.

	134184	39,00
	134184NM	60,00
	134184BM	60,00
	134184AC	60,00
	134184KM	60,00
	134184KMB	60,00
	134184OR	100,00
	134184OM	100,00
	134184OP	100,00
	134184OPM	100,00



Percha

	16123620	18,00
	16123620NM	28,00
	16123620BM	28,00
	16123620AC	28,00
	16123620KM	28,00
	16123620KMB	28,00
	16123620OR	40,00
	16123620OM	40,00
	16123620OP	40,00
	16123620OPM	40,00



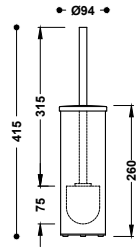

Escobillero de suelo



16133602	72,00
16133602NM	112,00
16133602BM	112,00
16133602AC	112,00
16133602KM	112,00
16133602KMB	112,00
16133602OR	216,00
16133602OM	216,00
16133602OP	216,00
16133602OPM	216,00

CLÁSICO

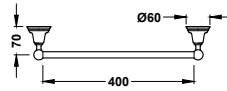

Toallero
400 mm.

12423601	78,00
12423601AC	121,00
12423601OR	172,00
12423601LV	113,00
12423601LM	113,00

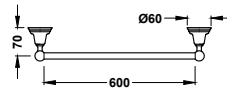

Toallero
600 mm.

12423603	82,00
12423603AC	127,00
12423603OR	180,00
12423603LV	119,00
12423603LM	119,00

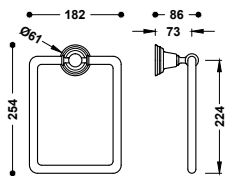

Toallero de anilla cuadrada

12463609	80,00
02463609AC	121,00
02463609OR	172,00
5246360951	113,00
02463609LM	113,00

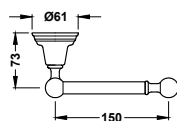

Portarrollos sin tapa

12423606	52,00
12423606AC	81,00
12423606OR	114,00
12423606LV	75,00
12423606LM	75,00

Percha

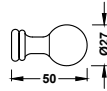

12423607	22,00
12423607AC	34,00
12423607OR	48,00
12423607LV	32,00
12423607LM	32,00

PACKS

Conjunto de 2 toalleros + 1 portarrollos + 1 percha

Toallero 400 mm. Toallero 600 mm.



09598101	183,00
09598101NM	290,00
09598101BM	290,00
09598101AC	290,00
09598101KM	290,00
09598101KMB	290,00
09598101OR	411,00
09598101OM	411,00
09598101OP	411,00
09598101OPM	411,00

Conjunto de 2 toalleros + 1 portarrollos + 1 percha

Toallero 480 mm. Toallero 580 mm.



09598102	166,00
09598102NM	257,00
09598102BM	257,00
09598102AC	257,00
09598102KM	257,00
09598102KMB	257,00
09598102OR	365,00
09598102OM	365,00
09598102OP	365,00
09598102OPM	365,00

DISPENSADORES DE JABÓN

Dispensador de jabón empotrado a encimera

Para encimeras o fregaderos. Capacidad: 0,4 litros. Material: Metálico.

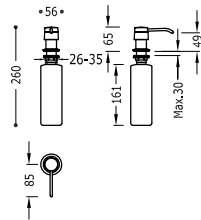

13474110	24,00
13474110NM	37,00
13474110BM	37,00
13474110AC	37,00
13474110OM	53,00

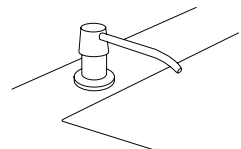

LLAVES DE PASO

Llave de paso empotrada

Conexión a rosca hembra: 1/2".

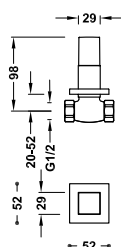

00715501	89,00
00715501NM	137,00
00715501BM	137,00
00715501AC	137,00
00715501OR	196,00
00715501OM	196,00

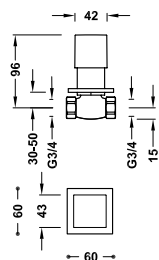

Llave de paso empotrada
Conexión a rosca hembra: 3/4".

107511 96,00

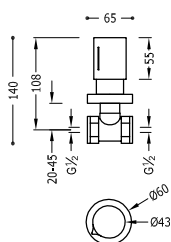

Llave de paso empotrada
Conexión a rosca hembra: 1/2".

06115501 83,00
06115501NM 128,00
06115501BM 128,00
06115501AC 128,00
06115501KM 128,00
06115501KMB 128,00
06115501OR 182,00
06115501OM 182,00
06115501OP 182,00
06115501OPM 182,00

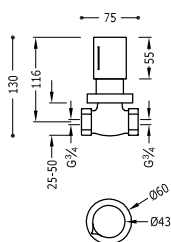

Llave de paso empotrada
Conexión a rosca hembra: 3/4".

06151101 91,00
06151101NM 140,00
06151101BM 140,00
06151101AC 140,00
06151101KM 140,00
06151101KMB 140,00
06151101OR 199,00
06151101OM 199,00
06151101OP 199,00
06151101OPM 199,00

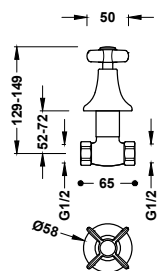

Llave de paso empotrada
Con conexión roscada de G1/2. Índice cerámico (frío).

24215501 93,00
24215501AC 145,00
24215501OR 206,00
24215501LV 136,00
24215501LM 136,00

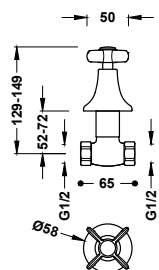

Llave de paso empotrada
Con conexión roscada de G1/2. Índice cerámico (caliente).

24215502 93,00
24215502AC 145,00
24215502OR 206,00
24215502LV 136,00
24215502LM 136,00





TECNOLOGÍA ELECTRÓNICA

- 419 Lavabos
- 425 Dispensadores de jabón
- 426 Sensores WC
- 426 Secador de manos
- 427 Cocina electrónica





GRIFOS ELECTRÓNICOS DE 1 AGUA

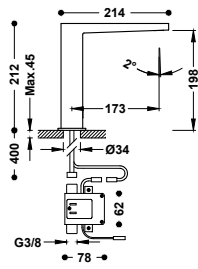

Grifo electrónico de 1 agua para lavabo
Accionado mediante sensor de infrarrojos.

- 20261310 357,00
- 20261310NM 553,00
- 20261310BM 553,00
- 20261310AC 553,00
- 20261310OR 785,00
- 20261310OM 785,00

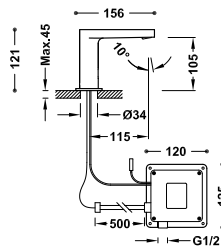

Grifo electrónico de 1 agua para lavabo
Accionado mediante sensor de infrarrojos. Caudal: 8,5 l/min.

- 20560301 310,00

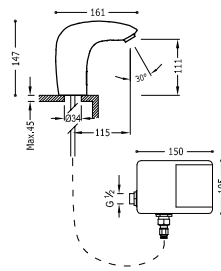

Grifo electrónico de 1 agua para lavabo
Accionado mediante sensor de infrarrojos.

- 19260603 305,00

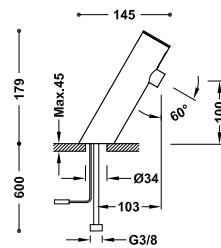

Grifo electrónico de 1 agua para lavabo
Accionado mediante sensor de infrarrojos. Caudal: 6 l/min.

- 39210302 163,00

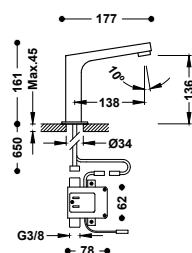

Grifo electrónico de 1 agua para lavabo
Accionado mediante sensor de infrarrojos.



- 39210317 209,00





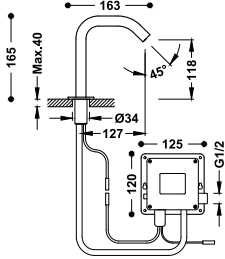

Grifo electrónico de 1 agua para lavabo ■ 39210303 315,00

Accionado mediante sensor de infrarrojos.

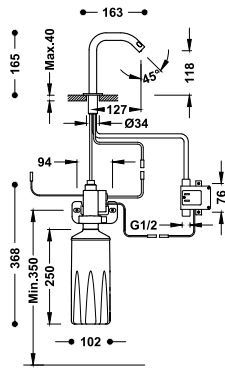

Grifo electrónico de 1 agua con dispensador de jabón automático para lavabo ■ 39210304 420,00

Accionado mediante sensor de infrarrojos. Capacidad del depósito de jabón: 1600 ml.

Grifo electrónico de 1 agua para lavabo ■ 39210305 399,00

Accionado mediante sensor de infrarrojos.

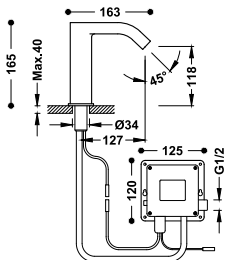
Grifo electrónico de 1 agua con dispensador de jabón automático para lavabo ■ 39210306 504,00

Accionado mediante sensor de infrarrojos. Capacidad del depósito de jabón: 1600 ml.



Grifo electrónico de 1 agua para lavabo
 Accionado mediante sensor de infrarrojos.

39210319

410,00

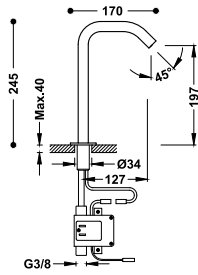

Grifo electrónico de 1 agua con dispensador de jabón automático para lavabo

39210320

515,00

Accionado mediante sensor de infrarrojos. Capacidad del depósito de jabón: 1600 ml.

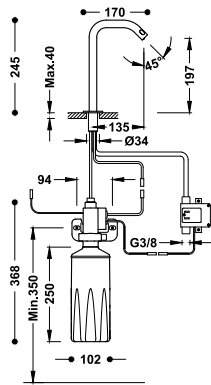

Grifo electrónico mural de 1 agua para lavabo

39210318

313,00

Accionado mediante sensor de infrarrojos. La caja de la batería está localizada dentro del mismo caño. Conexión roscada macho de G1/2.

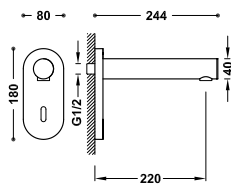

SIN HACER OBRAS

La caja de la batería está localizada dentro del mismo caño.
 Sistema patentado.



4 x
 AAA / LR06
 Baterías NO incluidas
 Larga duración: 8 años

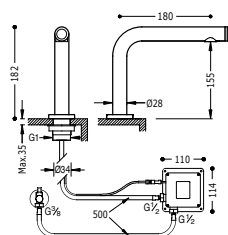

Grifo electrónico de 1 agua para lavabo

Sistema sensible al tacto Touch-tres.

06144701

278,00

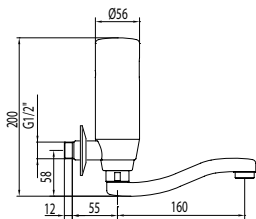

Grifo electrónico mural de 1 agua para lavabo

Accionado mediante sensor de infrarrojos.

09217101

273,00



GRIFOS ELECTRÓNICOS CON SISTEMA PREMEZCLADOR

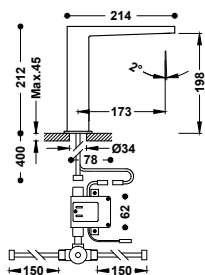

Grifo electrónico con sistema premezclador para lavabo

Accionado mediante sensor de infrarrojos. Incluye una válvula mezcladora de 2 aguas con tubos flexibles.

20261320

399,00

20261320NM

618,00

20261320BM

618,00

20261320AC

618,00

20261320OR

878,00

20261320OM

878,00

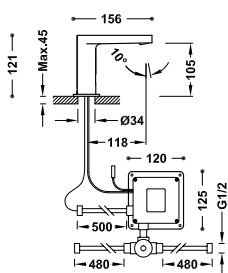

Grifo electrónico con sistema premezclador para lavabo

Accionado mediante sensor de infrarrojos. Incluye una válvula mezcladora de 2 aguas con tubos flexibles.

20560302

352,00

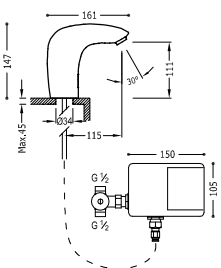

Grifo electrónico con sistema premezclador para lavabo

Accionado mediante sensor de infrarrojos. Incluye una válvula mezcladora de 2 aguas con tubos flexibles.

19290603

347,00



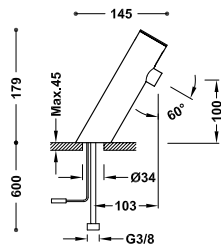

Grifo electrónico con sistema premezclador para lavabo
 Accionado mediante sensor de infrarrojos. Con selector de temperatura a través de una palanca lateral. Caudal: 6 l/min.

39210301

205,00

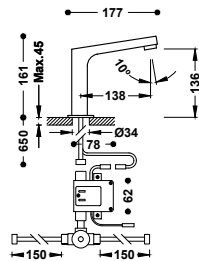

Grifo electrónico con sistema premezclador para lavabo
 Accionado mediante sensor de infrarrojos. Incluye una válvula mezcladora de 2 aguas con tubos flexibles.

39210309

251,00

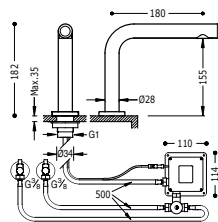

Grifo electrónico con sistema premezclador para lavabo
 Sistema sensible al tacto Touch-tres. Incluye una válvula mezcladora de 2 aguas con tubos flexibles.

06144801

310,00

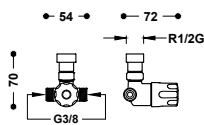

Válvula mezcladora de agua caliente-fría
 Apto para hacer llegar agua premezclada a un grifo de 1 agua de lavabo y cocina.

29944601

55,00



KITS DE GRIFO ELECTRÓNICO

Kit de grifo electrónico de 1 agua para lavabo

39210391

204,00

39210302 - Grifo electrónico de 1 agua para lavabo.
 134215028 - Válvula de desagüe siempre abierto para lavabo.
 134215024 - Sifón curvo articulado para lavabo.
 134215007 x 1 - Llave de escuadra con filtro.

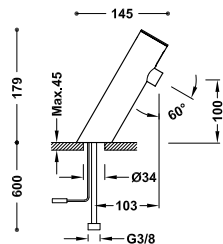

Kit de grifo electrónico con sistema premezclador para lavabo

39210390

254,00

39210301 - Grifo electrónico con sistema premezclador para lavabo.
 134215028 - Válvula de desagüe siempre abierto para lavabo.
 134215024 - Sifón curvo articulado para lavabo.
 134215007 x 2 - Llave de escuadra con filtro.

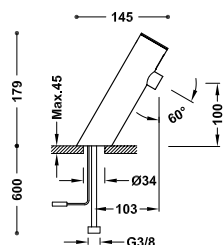

Kit de grifo electrónico de 1 agua para lavabo

39210397

250,00

39210317 - Grifo electrónico de 1 agua para lavabo.
 134215028 - Válvula de desagüe siempre abierto para lavabo.
 134215024 - Sifón curvo articulado para lavabo.
 134215007 x 1 - Llave de escuadra con filtro.

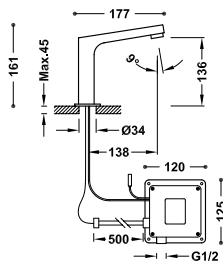

Kit de grifo electrónico con sistema premezclador para lavabo

39210399

300,00

39210309 - Grifo electrónico con sistema premezclador para lavabo.
 134215028 - Válvula de desagüe siempre abierto para lavabo.
 134215024 - Sifón curvo articulado para lavabo.
 134215007 x 2 - Llave de escuadra con filtro.

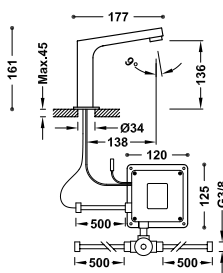

DISPENSADORES DE JABÓN

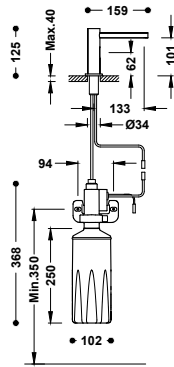

Dispensador electrónico de jabón para lavabo y cocina
 Accionado mediante sensor de infrarrojos. Capacidad del depósito de jabón: 1.600 ml.

- 39274101 310,00
- 39274101NM 480,00

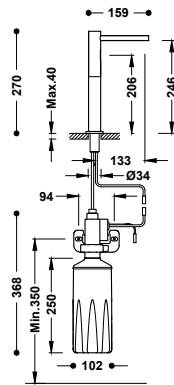

Dispensador electrónico alto de jabón para lavabo y cocina
 Accionado mediante sensor de infrarrojos. Capacidad del depósito de jabón: 1.600 ml.

- 39274102 315,00

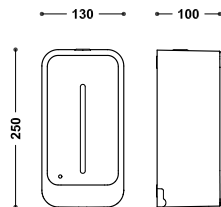

Dispensador electrónico de gel o jabón
 Accionado mediante sensor de infrarrojos. Capacidad del depósito de jabón: 1.000 ml.

- 01240801 68,00

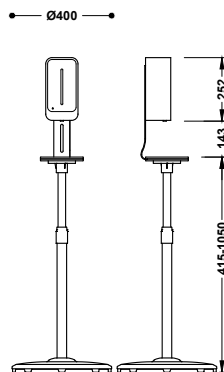

Soporte a suelo con estante y dispensador electrónico de gel o jabón
 Ajustable en altura para el hogar, negocio, escuela, hotel.
 Capacidad del depósito de jabón: 1.000 ml.

- 01240850 152,00



SENSORES WC

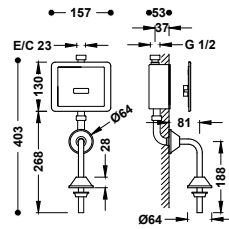

Grifo electrónico empotrado con sensor para urinario
 Accionado mediante sensor de infrarrojos. Con un tubo adaptable a urinario. Material: Acero inoxidable.

01220704

185,00

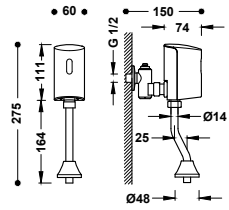

Grifo de descarga electrónico mural de 1 agua para urinario
 Accionado mediante sensor de infrarrojos. Con un tubo adaptable a urinario.

01220703

130,00



SECADOR DE MANOS

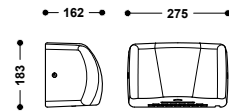

Secador de manos automático por aire caliente
 Accionado mediante sensor de infrarrojos.

39274201

202,00

39274201AC

202,00

39274201BL

202,00



COCINA ELECTRÓNICA

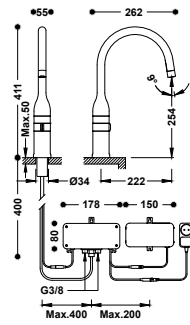

Grifo electrónico para cocina

- Accionado mediante sensor de infrarrojos.
- Con regulación de temperatura mediante volante en el cuerpo.
- Con latiguillos de alimentación flexibles G3/8.

23044501	630,00
23044501NM	976,00
23044501AC	976,00
230445010M	1.323,00
230445010PM	1.323,00

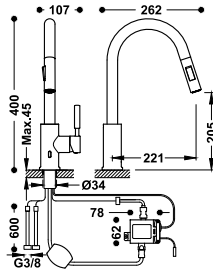

Grifo electrónico con caño extraíble y 2 tipos de chorro para cocina

Accionado mediante sensor de infrarrojos. Con regulador de caudal y temperatura a través de una maneta lateral. Material: Acero inoxidable.

09244501AC	345,00
------------	--------

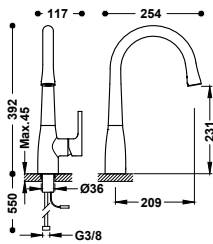

Grifo electrónico para cocina

Accionado mediante sensor de infrarrojos situado detrás de la salida del agua. Con regulador de caudal y temperatura a través de una maneta lateral.

09244601	310,00
----------	--------

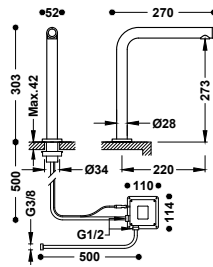

Grifo electrónico de 1 agua para cocina

Sistema sensible al tacto Touch-tres. Con latiguillo de alimentación flexible G3/8.

161445	325,00
--------	--------

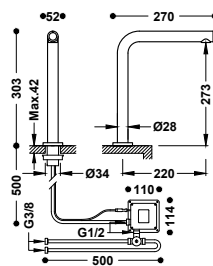

Grifo electrónico con sistema premezclador para cocina

Sistema sensible al tacto Touch-tres. Incluye una válvula mezcladora de 2 aguas con tubos flexibles. Con latiguillos de alimentación flexibles G3/8.

161446	375,00
--------	--------







































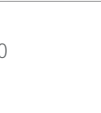

























ESPACIO DE COCINA

- 436 Monomandos
- 446 Para agua filtrada
- 450 Con caño abatible
- 450 Con caño flexible
- 452 Con caño extraíble
- 455 Electrónicos
- 456 Bimandos
- 459 A muro
- 462 Industriales
- 464 Grifos para varios usos



MONOMANDOS





Referencia	Página	Acabados disponibles	Tecnología	Altura (mm)
 106486	→436			300
 130496	→436			305
 106440	→436			270
 23044002	→436			300
 20548601	→436			296
 162435	→437			310
 130336	→437			286
 23044006	→437			337
 162436	→437			304
 181436	→437			304
 23044007	→438			337

Referencia	Página	Acabados disponibles	Tecnología	Altura (mm)
 24234101	→438			293
 24244101	→438			268
 23044003	→438			410
 23044005	→438			424
 20044002	→439			418
 20544001 06254201	→439			418
 181540	→439			417
 162440	→439			426
 162442	→440			350
 21644020 21644010	→440		 	378
 181341 183341	→440			351
 169440 117440	→441			380

Referencia	Página	Acabados disponibles	Tecnología	Altura (mm)
 06944001	→441			330
 139441 17044102 21544101	→441			260
 172440 17044002	→442			233
 07044802	→442			261
 06944701 172447 17044702	→442			352
 21644720 21644710	→443			338
 08333301	→443			300
 117333 17033302 172333 21533301	→444			180

PARA AGUA FILTRADA





 23045301	→446			424
 23045403	→446			313
 23045402	→446			375

Referencia	Página	Acabados disponibles	Tecnología	Altura (mm)
 23050401	→446			263
 23050402	→446			271





CON CAÑO ABATIBLE



 23033503	→450			256
 130335	→450			256
 23033502	→450			320
 24233401	→450			293

CON CAÑO FLEXIBLE























 00648701	→450			455
 23048702	→451			469
 23048701	→451			469
 20548702	→451			450

















Referencia	Página	Acabados disponibles	Tecnología	Altura (mm)
 03048501	→451			548
 03049301	→451			564

Referencia	Página	Acabados disponibles	Tecnología	Altura (mm)
 03043401	→454			394
 23043840	→454			

CON CAÑO EXTRAÍBLE







 106437	→452			300
 23043801	→452			417
 23043803	→452			369
 162438 181438	→452			315
 162437 181437	→453			293
 23043802	→453			455
 23043804	→453			461
 114444	→453			370
 06944401 03044401	→454			300

ELECTRÓNICOS

 23044501	→455			411
 09244501AC	→455		 	400
 09244601	→455		 	392
 161445 161446	→455		 	303



BIMANDOS

 163333	→456			427
 24234201	→456			256
 123342	→456			286
 24231001	→456			283*

Referencia	Página	Acabados disponibles	Tecnología	Altura (mm)
 123310 123210	→456	<input type="checkbox"/>		270*
 24221501	→457	<input type="checkbox"/> <input type="checkbox"/> <input type="checkbox"/> <input type="checkbox"/>		284*
 123214 123215 123230	→457	<input type="checkbox"/>		219*
 123314 123315 123330 123360	→458	<input type="checkbox"/>		219*
 123416	→458	<input type="checkbox"/>		309*
 123317	→459	<input type="checkbox"/>		301*
 123217	→459	<input type="checkbox"/>		301*

A MURO

 172318 172317	→459	<input type="checkbox"/>		287* 293*
 07032003 17041802 17032002	→459	<input type="checkbox"/>		217* 247* 287*
 21632010 21632020 21632030	→460	<input type="checkbox"/>		182* 242* 281*
 172420 17033202	→461	<input type="checkbox"/>		305* 305*

Referencia	Página	Acabados disponibles	Tecnología	Altura (mm)
 172218 172418	→461	<input type="checkbox"/>		283* 283*
 17031802 17021802	→461	<input type="checkbox"/>		283* 283*
 21642010	→462	<input type="checkbox"/>		277*

INDUSTRIALES

 130495	→462	<input type="checkbox"/>		760
 130484	→463	<input type="checkbox"/>		1355
 130481	→463	<input type="checkbox"/>		1200

PARA VARIOS USOS

 123306	→464	<input type="checkbox"/>		265
 123505	→464	<input type="checkbox"/>		298*
 123506	→464	<input type="checkbox"/>		248*

* Longitud del caño







MONOMANDOS

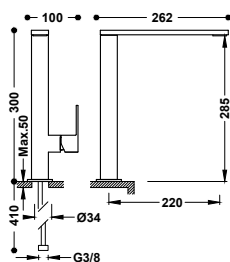

Grifo monomando para cocina

Con latiguillos de alimentación flexibles G3/8.

■ 106486	420,00
■ 006486NM	651,00
■ 006486BM	651,00
■ 50648603	651,00
■ 006486OM	924,00

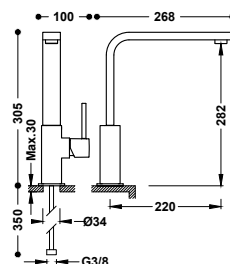

Grifo monomando para cocina

Con latiguillos de alimentación flexibles G3/8.

■ 130496	304,00
■ 030496NM	471,00
■ 030496BM	471,00
■ 53049603	471,00
■ 030496OM	669,00

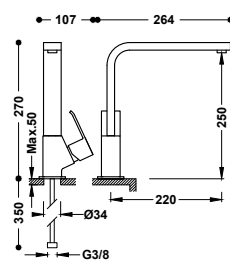

Grifo monomando para cocina

Con latiguillos de alimentación flexibles G3/8.

■ 106440	360,00
----------	--------

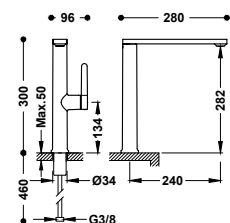

Grifo monomando para cocina

Con latiguillos de alimentación flexibles G3/8.

■ 23044002	245,00
■ 23044002NM	380,00
■ 23044002BM	380,00
■ 23044002AC	380,00
■ 23044002OM	539,00
■ 23044002OPM	539,00

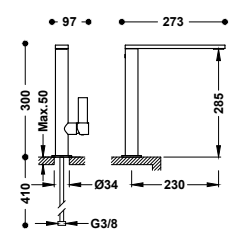

Grifo monomando para cocina

Con latiguillos de alimentación flexibles G3/8.

■ 20548601	250,00
■ 20548601NM	388,00
■ 20548601BM	388,00
■ 20548601AC	388,00
■ 20548601OM	550,00



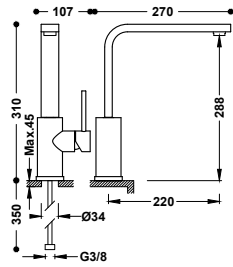

Grifo monomando para cocina

Con latiguillos de alimentación flexibles G3/8.

■ 162435	265,00
■ 062435NM	411,00
■ 062435BM	411,00
■ 062435AC	411,00
■ 062435OM	583,00

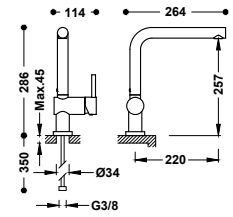

Grifo monomando para cocina

Con latiguillos de alimentación flexibles G3/8.

■ 130336	240,00
■ 030336BM	372,00
■ 030336AC	372,00

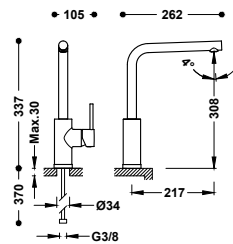

Grifo monomando para cocina

Con latiguillos de alimentación flexibles G3/8.

■ 23044006	160,00
■ 23044006NM	248,00
■ 23044006AC	248,00

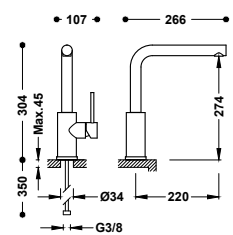

Grifo monomando para cocina

Con latiguillos de alimentación flexibles G3/8.

■ 162436	230,00
■ 06243601NM	357,00
■ 06243601BM	357,00
■ 06243601AC	357,00
■ 06243601OM	506,00

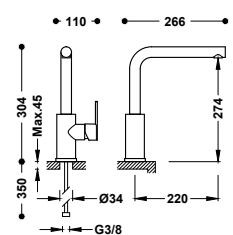

Grifo monomando para cocina

Con latiguillos de alimentación flexibles G3/8.

■ 181436	210,00
----------	--------



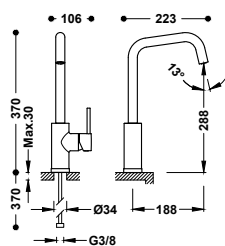

Grifo monomando para cocina
Con latiguillos de alimentación flexibles G3/8.

- 23044007 140,00
- 23044007NM 217,00
- 23044007AC 217,00

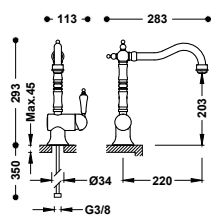

Grifo monomando para cocina
Con latiguillos de alimentación flexibles G3/8.

- 24234101 321,00
- 24234101AC 498,00
- 24234101OR 706,00
- 24234101LV 465,00
- 24234101LM 465,00

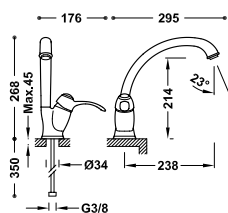

Grifo monomando para cocina
Con latiguillos de alimentación flexibles G3/8.

- 24244101 210,00
- 24244101AC 326,00
- 24244101OR 462,00
- 24244101LV 305,00
- 24244101LM 305,00

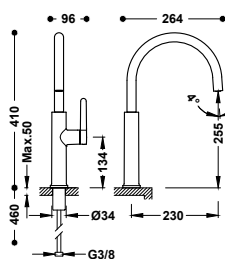

Grifo monomando para cocina
Con latiguillos de alimentación flexibles G3/8.

- 23044003 220,00
- 23044003NM 341,00
- 23044003BM 341,00
- 23044003AC 341,00
- 23044003OM 484,00
- 23044003OPM 484,00

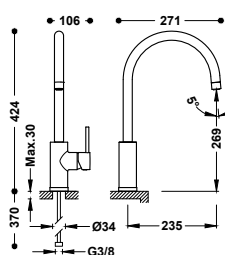

Grifo monomando para cocina
Con latiguillos de alimentación flexibles G3/8.

- 23044005 125,00
- 23044005NM 194,00
- 23044005AC 194,00



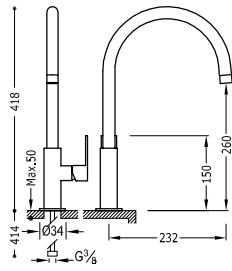

Grifo monomando para cocina

Con latiguillos de alimentación flexibles G3/8.

■ 20044002	232,00
■ 20044002NM	360,00
■ 20044002BM	360,00
■ 20044002AC	360,00

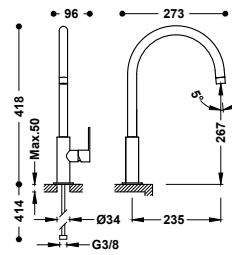

Grifo monomando para cocina

Con latiguillos de alimentación flexibles G3/8.

■ 20544001	228,00
■ 20544001NM	353,00
■ 20544001BM	353,00
■ 20544001AC	353,00
■ 20544001OM	502,00

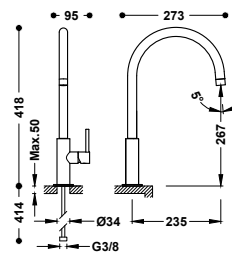

Grifo monomando para cocina

Con latiguillos de alimentación flexibles G3/8.

■ 06254201	224,00
■ 06254201NM	347,00
■ 06254201BM	347,00
■ 06254201AC	347,00
■ 06254201OM	493,00

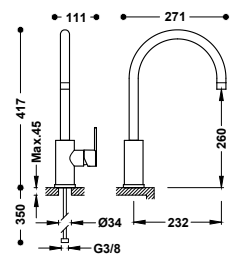

Grifo monomando para cocina

Con latiguillos de alimentación flexibles G3/8.

■ 181540	228,00
----------	--------

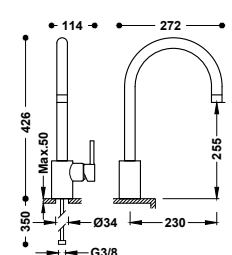

Grifo monomando para cocina

Con latiguillos de alimentación flexibles G3/8.

■ 162440	200,00
■ 56244003	310,00



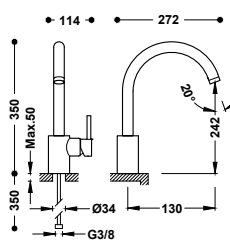

Grifo monomando para cocina
Con latiguillos de alimentación flexibles G3/8.

162442 180,00

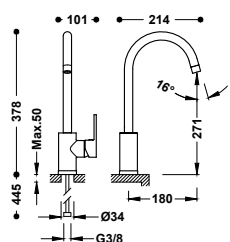

Grifo monomando para cocina
Con latiguillos de alimentación flexibles G3/8.

21644020 89,00

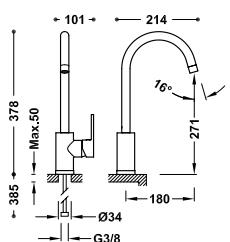

Grifo monomando para cocina
Con latiguillos de alimentación flexibles G3/8.

21644010 83,00

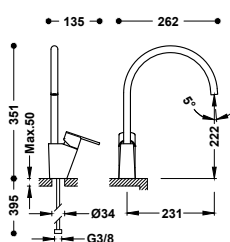

Grifo monomando para cocina
Con latiguillos de alimentación flexibles G3/8.

181341 135,00

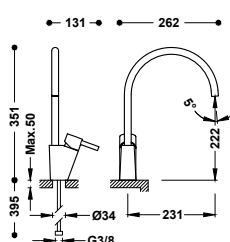

Grifo monomando para cocina
Con latiguillos de alimentación flexibles G3/8.

183341 125,00



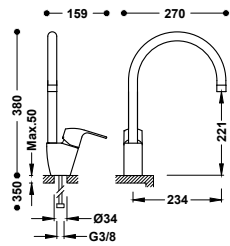

Grifo monomando para cocina
Con latiguillos de alimentación flexibles G3/8.

169440 112,00



913429510

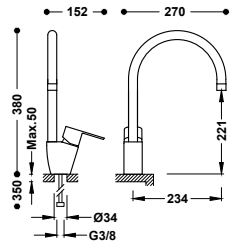

Grifo monomando para cocina
Con latiguillos de alimentación flexibles G3/8.

117440 112,00



913429510

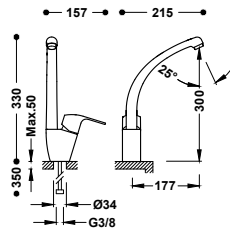

Grifo monomando para cocina
Con latiguillos de alimentación flexibles G3/8.

06944001 106,00



913427010

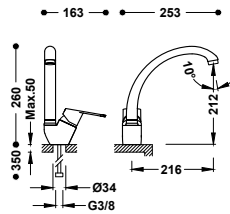

Grifo monomando para cocina
Con latiguillos de alimentación flexibles G3/8.

139441 85,00



913438510

IA

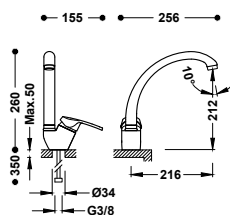

Grifo monomando para cocina
Con latiguillos de alimentación flexibles G3/8.

17044102 76,00



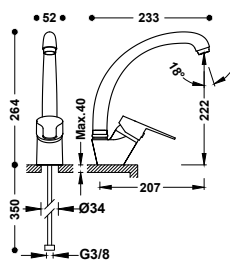

Grifo monomando para cocina
Con latiguillos de alimentación flexibles G3/8.

21544101 71,00

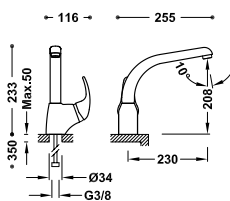

Grifo monomando para cocina
Con latiguillos de alimentación flexibles G3/8.

172440 112,00

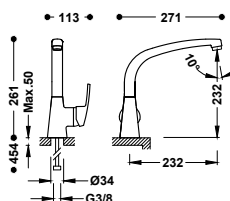

Grifo monomando para cocina
Con latiguillos de alimentación flexibles G3/8.

07044802 108,00

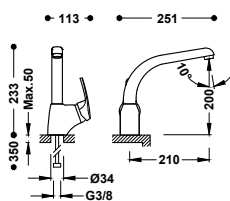

Grifo monomando para cocina
Con latiguillos de alimentación flexibles G3/8.

17044002 108,00

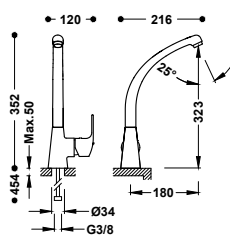

Grifo monomando para cocina
Con latiguillos de alimentación flexibles G3/8.

06944701 102,00



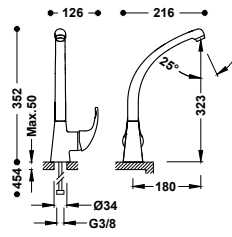

Grifo monomando para cocina

Con latiguillos de alimentación flexibles G3/8.

172447

102,00

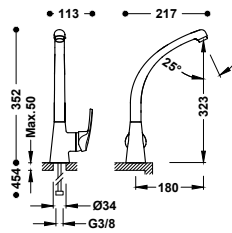

Grifo monomando para cocina

Con latiguillos de alimentación flexibles G3/8.

17044702

102,00

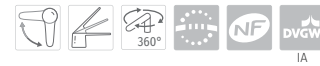
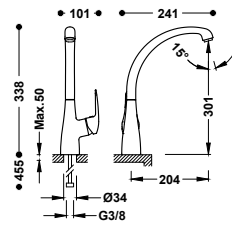

Grifo monomando para cocina

Con latiguillos de alimentación flexibles G3/8.

21644720

84,00

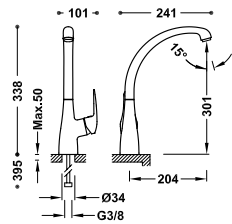

Grifo monomando para cocina

Con latiguillos de alimentación flexibles G3/8.

21644710

78,00

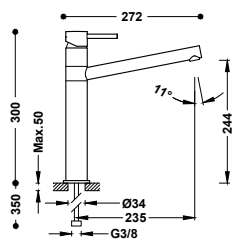

Grifo monomando para cocina

Con latiguillos de alimentación flexibles G3/8.

08333301

168,00

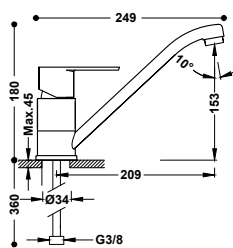

Grifo monomando para cocina
Con latiguillos de alimentación flexibles G3/8.

117333

93,00

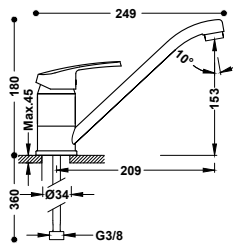

Grifo monomando para cocina
Con latiguillos de alimentación flexibles G3/8.

17033302

85,00

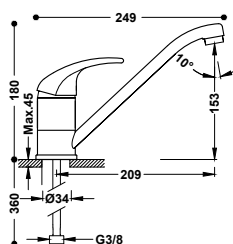

Grifo monomando para cocina
Con latiguillos de alimentación flexibles G3/8.

172333

82,00

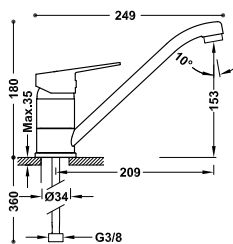

Grifo monomando para cocina
Con latiguillos de alimentación flexibles G3/8.

21533301

65,00





PARA AGUA FILTRADA

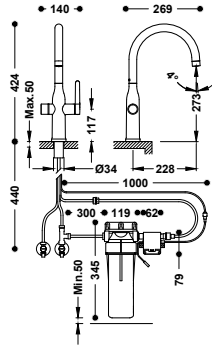

Grifo monomando de 2 vías para cocina, para agua de red y filtrada

- Con sistema táctil para agua filtrada.
- Incluye filtro para 6 meses (10.000 litros) de agua filtrada.
- El filtro elimina bacterias, virus y metales pesados.
- Latiguillos de alimentación flexibles G3/8.

■ 23045301	470,00
■ 23045301NM	705,00
■ 23045301AC	705,00
■ 23045301OM	987,00
■ 23045301OPM	987,00

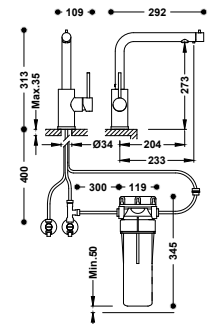

Grifo monomando de 2 vías para cocina, para agua de red y filtrada

- Cierre y regulación de caudal independientes.
- Incluye filtro para 6 meses (10.000 litros) de agua filtrada.
- El filtro elimina bacterias, virus y metales pesados.
- Latiguillos de alimentación flexibles G3/8.

■ 23045403	311,00
■ 23045403NM	434,00

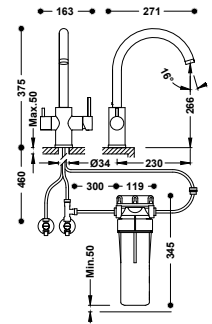

Grifo monomando de 2 vías para cocina, para agua de red y filtrada

- Cierre y regulación de caudal independientes.
- Incluye filtro para 6 meses (10.000 litros) de agua filtrada.
- El filtro elimina bacterias, virus y metales pesados.
- Latiguillos de alimentación flexibles G3/8.

■ 23045402	311,00
■ 23045402NM	434,00

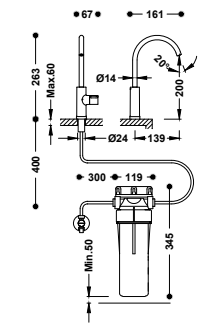

Grifo de 1 agua para cocina, para agua filtrada

- Incluye filtro para 6 meses (10.000 litros) de agua filtrada.
- El filtro elimina bacterias, virus y metales pesados.
- Latiguillo de alimentación flexible G3/8.

■ 23050401	243,00
■ 23050401NM	344,00
■ 23050401OM	481,00
■ 23050401OPM	481,00

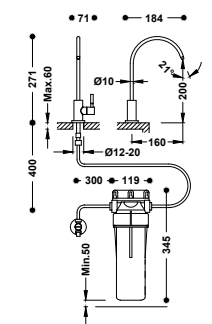

Grifo de 1 agua para cocina, para agua filtrada

- Incluye filtro para 6 meses (10.000 litros) de agua filtrada.
- El filtro elimina bacterias, virus y metales pesados.
- Latiguillo de alimentación flexible G3/8.

■ 23050402	162,00
------------	--------



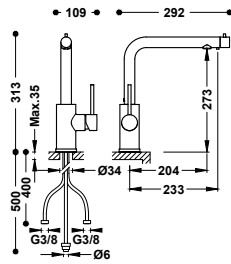

Grifo monomando de 2 vías para cocina, para agua de red y filtrada

- Cierre y regulación de caudal independientes.
- Latiguillos de alimentación flexibles G3/8.

■ 23045303	250,00
■ 23045303NM	388,00

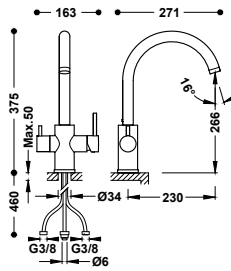

Grifo monomando de 2 vías para cocina, para agua de red y filtrada

- Cierre y regulación de caudal independientes.
- Latiguillos de alimentación flexibles G3/8.

■ 23045302	250,00
■ 23045302NM	388,00

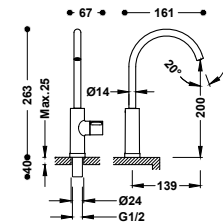

Grifo de 1 agua para cocina, para agua filtrada

- Con latiguillo de alimentación flexible G3/8.

■ 23050301	150,00
■ 23050301NM	233,00
■ 23050301OM	330,00
■ 23050301OPM	330,00

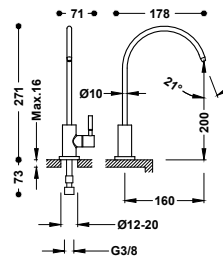

Grifo de 1 agua para cocina, para agua filtrada

- Con latiguillo de alimentación flexible G3/8.

■ 23050302	60,00
------------	-------





El filtro aprovecha el 100% del agua de red.

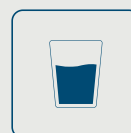

Elimina las impurezas respetando las propiedades minerales del agua.



Evita tener que usar botellas de agua, reduciendo el impacto medioambiental.



Agua purificada en casa, por menos dinero.



El filtro purificador Seven+ de Tres proporciona una protección inmejorable contra los contaminantes y virus presentes en el agua, así como un agua de buen sabor.





Seven+

- Elimina: Sustancias químicas, productos farmacéuticos, metales pesados, pesticidas, bacterias, partículas y virus.
- 10.000 litros de eficacia con un uso regular.
- Mínima instalación en el mínimo espacio.
- El filtro se sustituye fácilmente.

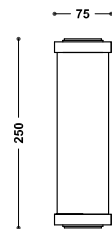

Filtro purificador de agua Seven+

29945302

62,00

El filtro elimina gran parte de bacterias, virus y metales pesados.

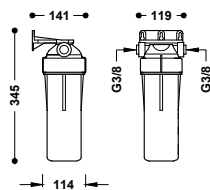

Contenedor con filtro purificador de agua Seven+

29945303

120,00

- Incluye filtro para 6 meses (10.000 litros) de agua filtrada.
- El filtro elimina bacterias, virus y metales pesados.



Conexiones para adaptar el contenedor y filtro Seven+ con cualquier grifo de cocina de dos vías

29945304

53,00



CON CAÑO ABATIBLE

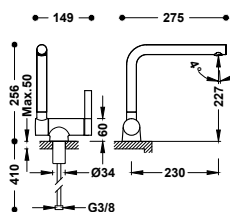

Grifo monomando con caño abatible para cocina

- Con latiguillos de alimentación flexibles G3/8.
- Altura total con el caño abatido de 6 cm.

23033503	240,00
23033503NM	372,00
23033503BM	372,00
23033503AC	372,00
23033503OM	528,00
23033503OPM	528,00

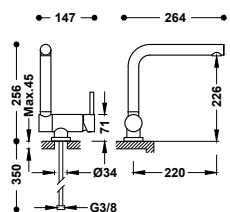

Grifo monomando con caño abatible para cocina

- Con latiguillos de alimentación flexibles G3/8.
- Altura total con el caño abatido de 7,1 cm.

130335	255,00
030335NM	395,00
030335BM	395,00
030335AC	395,00
030335OM	561,00

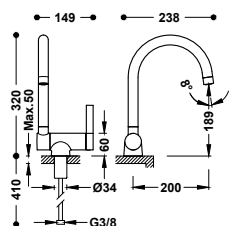

Grifo monomando con caño abatible para cocina

- Con latiguillos de alimentación flexibles G3/8.
- Altura total con el caño abatido de 6 cm.

23033502	220,00
23033502NM	341,00
23033502BM	341,00
23033502AC	341,00
23033502OM	484,00
23033502OPM	484,00

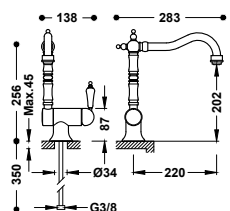

Grifo monomando con caño abatible para cocina

- Con latiguillos de alimentación flexibles G3/8.
- Altura total con el caño abatido de 8,7 cm.

24233401	400,00
24233401AC	620,00
24233401OR	880,00
24233401LV	580,00
24233401LM	580,00



CON CAÑO FLEXIBLE

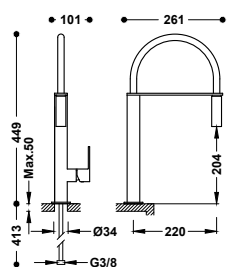

Grifo monomando con caño flexible para cocina

- Con latiguillos de alimentación flexibles G3/8.

00648701	485,00
00648701NM	752,00
00648701BM	752,00
00648701AC	752,00



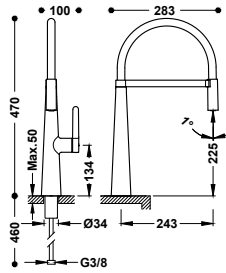

Grifo monomando con caño flexible para cocina

- Fijación del caño al soporte mediante imán.
- Con latiguillos de alimentación flexibles G3/8.

23048702	360,00
23048702NM	558,00
23048702OM	792,00
23048702OPM	792,00

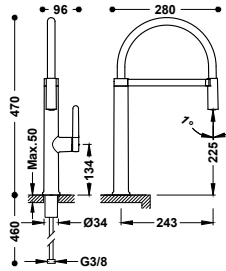

Grifo monomando con caño flexible para cocina

- Fijación del caño al soporte mediante imán.
- Con latiguillos de alimentación flexibles G3/8.

23048701	330,00
23048701OM	726,00
23048701OPM	726,00

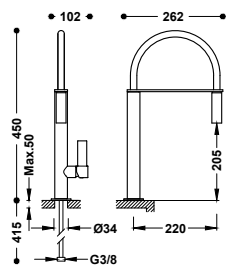

Grifo monomando con caño flexible para cocina

- Con latiguillos de alimentación flexibles G3/8.

20548702	435,00
20548702NM	674,00
20548702BM	674,00
20548702AC	674,00

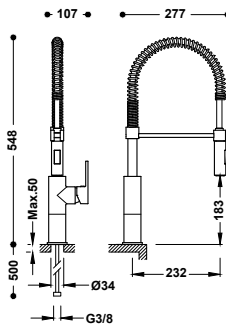

Grifo monomando con caño extraíble con 2 tipos de chorro para cocina

- Con latiguillos de alimentación flexibles G3/8.

03048501	300,00
----------	--------

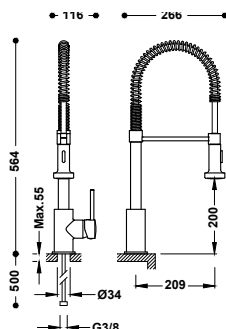

Grifo monomando con caño extraíble con 2 tipos de chorro para cocina

- Con latiguillos de alimentación flexibles G3/8.

03049301	294,00
----------	--------



CON CAÑO EXTRAÍBLE

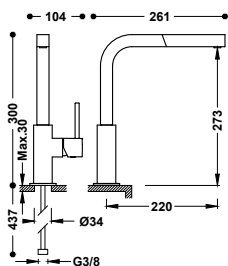

Grifo monomando con caño extraíble para cocina

Con latiguillos de alimentación flexibles G3/8.

- 106437 417,00
- 006437NM 646,00
- 006437BM 646,00
- 50643703 646,00
- 006437OM 917,00



910719005

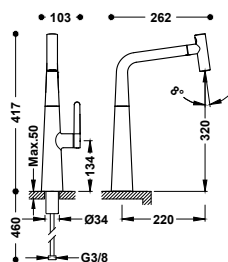

Grifo monomando con caño extraíble con 2 tipos de chorro para cocina

Con flexo retráctil de poliamida trenzada. Con latiguillos de alimentación flexibles G3/8.

- 23043801 340,00



29902506

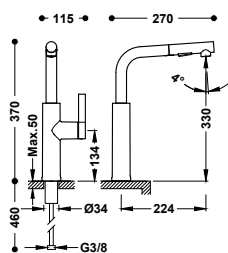

Grifo monomando con caño extraíble con 2 tipos de chorro para cocina

Con flexo retráctil de poliamida trenzada. Con latiguillos de alimentación flexibles G3/8.

- 23043803 260,00
- 23043803NM 403,00
- 23043803AC 403,00



29903516

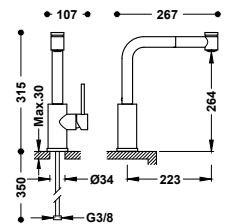

Grifo monomando con caño extraíble con 2 tipos de chorro para cocina

Con latiguillos de alimentación flexibles G3/8.

- 162438 270,00



9134591

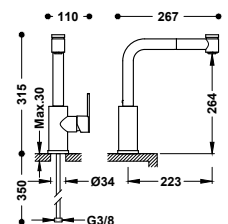

Grifo monomando con caño extraíble con 2 tipos de chorro para cocina

Con latiguillos de alimentación flexibles G3/8.

- 181438 260,00



9134591

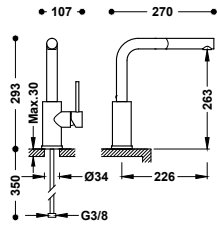

Grifo monomando con caño extraíble para cocina
Con latiguillos de alimentación flexibles G3/8.

- 162437 268,00
- 56243703 415,00



9134591

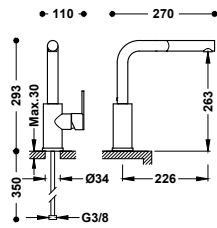

Grifo monomando con caño extraíble para cocina
Con latiguillos de alimentación flexibles G3/8.

- 181437 255,00



9134591

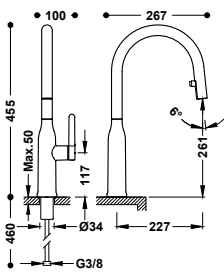

Grifo monomando con caño extraíble con 2 tipos de chorro para cocina
Con flexo retráctil de poliamida trenzada. Con latiguillos de alimentación flexibles G3/8.

- 23043802 300,00
- 23043802NM 465,00
- 23043802AC 465,00



29902506

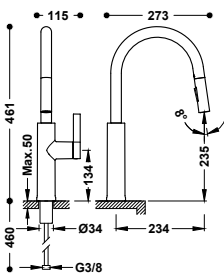

Grifo monomando con caño extraíble con 2 tipos de chorro para cocina
Con flexo retráctil de poliamida trenzada. Con latiguillos de alimentación flexibles G3/8.

- 23043804 190,00
- 23043804NM 295,00



29903516

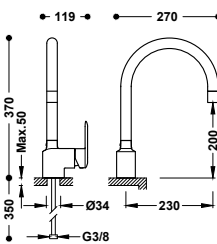

Grifo monomando con caño extraíble para cocina
Con latiguillos de alimentación flexibles G3/8.

- 114444 315,00



9134288



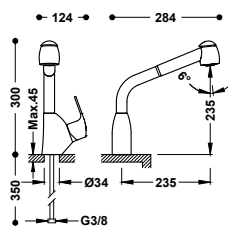

Grifo monomando con caño extraíble con 2 tipos de chorro para cocina

06944401

204,00

Con latiguillos de alimentación flexibles G3/8.

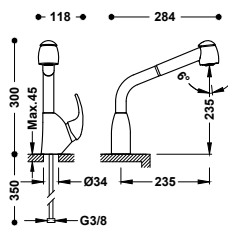

Grifo monomando con caño extraíble con 2 tipos de chorro para cocina

03044401

204,00

Con latiguillos de alimentación flexibles G3/8.

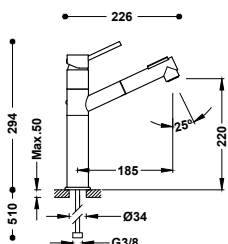

Grifo monomando con caño extraíble con 2 tipos de chorro para cocina

03043401

183,00

Con latiguillos de alimentación flexibles G3/8.

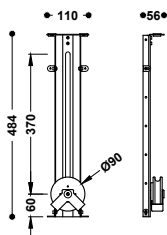

Kit para guiar el flexo del grifo de cocina extraíble

23043840

107,00



ELECTRÓNICOS

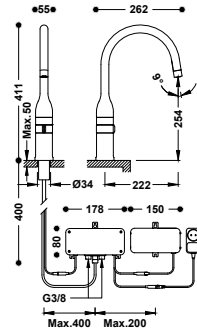

Grifo electrónico para cocina

- Accionado mediante sensor de infrarrojos.
- Con regulación de temperatura mediante volante en el cuerpo.
- Con latiguillos de alimentación flexibles G3/8.

23044501	630,00
23044501NM	976,00
23044501AC	976,00
230445010M	1.323,00
230445010PM	1.323,00

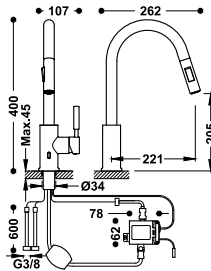

Grifo electrónico con caño extraíble y 2 tipos de chorro para cocina

Accionado mediante sensor de infrarrojos. Con regulador de caudal y temperatura a través de una maneta lateral. Material: Acero inoxidable.

09244501AC	345,00
------------	--------

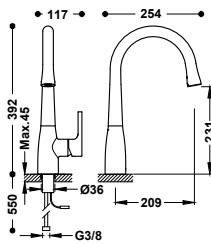

Grifo electrónico para cocina

Accionado mediante sensor de infrarrojos situado detrás de la salida del agua. Con regulador de caudal y temperatura a través de una maneta lateral.

09244601	310,00
----------	--------

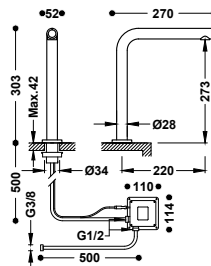

Grifo electrónico de 1 agua para cocina

Sistema sensible al tacto Touch-tres. Con latiguillo de alimentación flexible G3/8.

161445	325,00
--------	--------

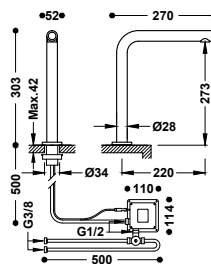

Grifo electrónico con sistema premezclador para cocina

Sistema sensible al tacto Touch-tres. Incluye una válvula mezcladora de 2 aguas con tubos flexibles. Con latiguillos de alimentación flexibles G3/8.

161446	375,00
--------	--------



BIMANDOS

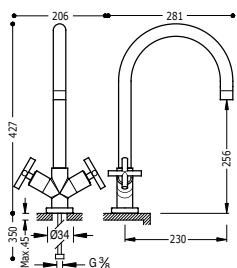

Grifo bimando para cocina
Con latiguillos de alimentación flexible G3/8.

163333 295,00

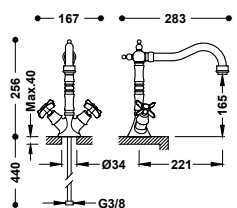

Grifo bimando para cocina
Con latiguillos de alimentación flexibles G3/8.

24234201 237,00
24234201AC 367,00
24234201OR 521,00
24234201LV 344,00
24234201LM 344,00



9134282

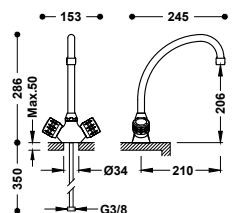

Grifo bimando para cocina
Con latiguillos de alimentación flexibles G3/8.

123342 85,00

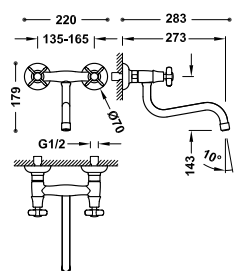

Grifo bimando mural para cocina
Con caño inferior. Distancia a pared: 273 mm.

24231001 230,00
24231001AC 357,00
24231001OR 506,00
24231001LV 334,00
24231001LM 334,00



9134282

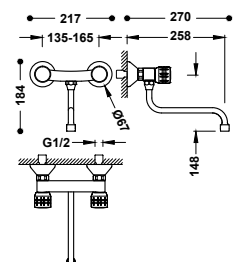

Grifo bimando mural para cocina
Con caño inferior. Distancia a pared: 258 mm.

123310 78,00



13 - 16

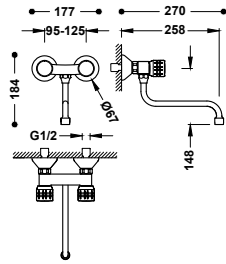

Grifo bimando mural para cocina

123210

75,00

Con caño inferior. Excentricidad especial. Distancia a pared: 258 mm.

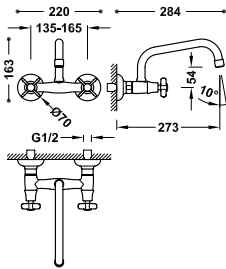

Grifo bimando mural para cocina

24221501

235,00

Con caño superior. Distancia a pared: 273 mm.

24221501AC

364,00

24221501OR

517,00

24221501LV

341,00

24221501LM

341,00

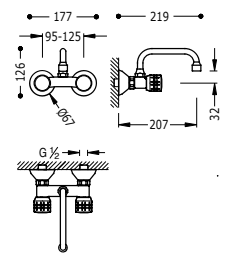

Grifo bimando mural para cocina

123214

76,00

Con caño superior. Excentricidad especial. Distancia a pared: 207 mm.

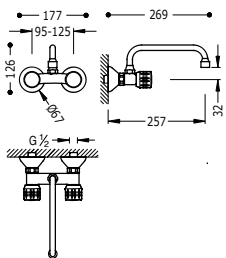

Grifo bimando mural para cocina

123215

78,00

Con caño superior. Excentricidad especial. Distancia a pared: 257 mm.

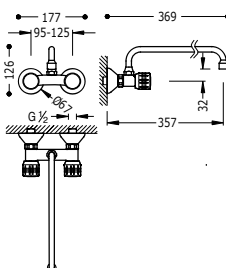

Grifo bimando mural para cocina

123230

80,00

Con caño superior. Excentricidad especial. Distancia a pared: 357 mm.



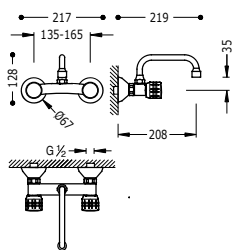

Grifo bimando mural para cocina

Con caño superior. Distancia a pared: 208 mm.

123314

78,00

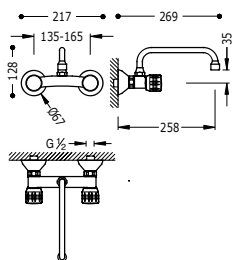

Grifo bimando mural para cocina

Con caño superior. Distancia a pared: 258 mm.

123315

80,00

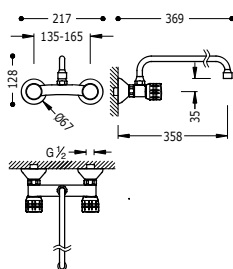

Grifo bimando mural para cocina

Con caño superior. Distancia a pared: 358 mm.

123330

82,00

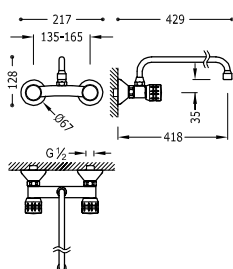

Grifo bimando mural para cocina

Con caño superior. Distancia a pared: 418 mm.

123360

86,00

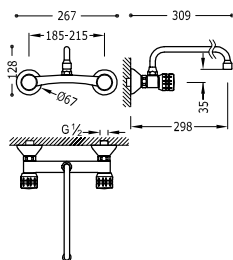

Grifo bimando mural para cocina

Con caño superior. Excentricidad especial. Distancia a pared: 298 mm.

123416

96,00



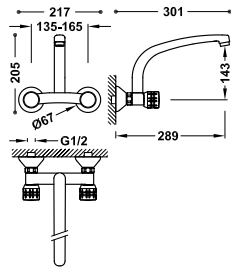

Grifo bimando mural para cocina
Con caño superior. Distancia a pared: 276 mm.

123317 99,00

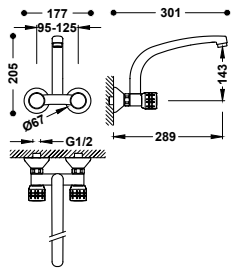

Grifo bimando mural para cocina
Con caño superior. Excentricidad especial. Distancia a pared: 276 mm.

123217 97,00



A MURO

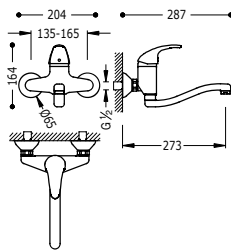

Grifo monomando mural para cocina
Con caño inferior. Distancia a pared: 273 mm.

172318 118,00

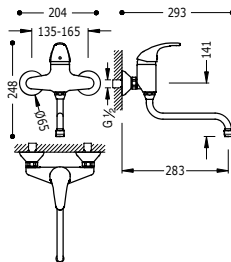

Grifo monomando mural para cocina
Con caño inferior. Distancia a pared: 283 mm.

172317 108,00

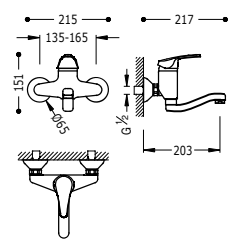
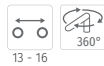

Grifo monomando mural para cocina
Con caño inferior. Distancia a pared: 203 mm.

07032003 100,00



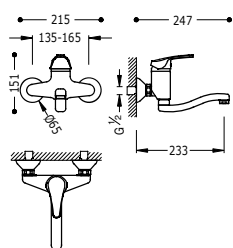

Grifo monomando mural para cocina
Con caño inferior. Distancia a pared: 233 mm.

17041802 105,00

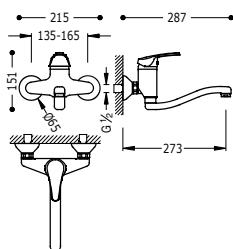

Grifo monomando mural para cocina
Con caño inferior. Distancia a pared: 273 mm.

17032002 107,00

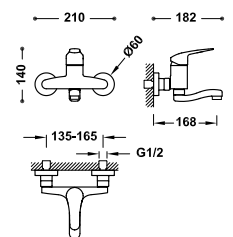

Grifo monomando mural para cocina
Con caño inferior. Distancia a pared: 168 mm.

21632010 84,00

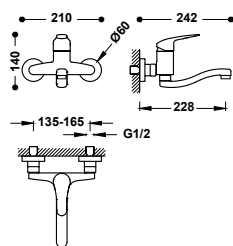

Grifo monomando mural para cocina
Con caño inferior. Distancia a pared: 228 mm.

21632020 86,00

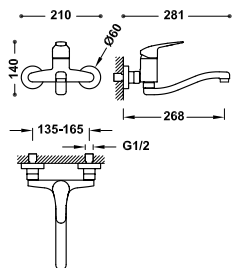

Grifo monomando mural para cocina
Con caño inferior. Distancia a pared: 268 mm.

21632030 88,00



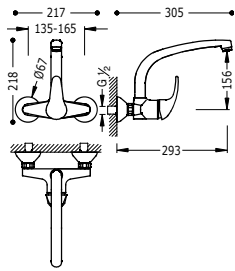

Grifo monomando mural para cocina

172420

118,00

Con caño superior. Distancia a pared: 293 mm.

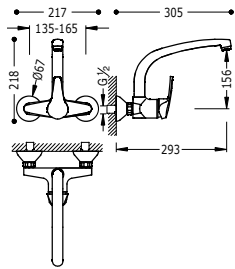

Grifo monomando mural para cocina

17033202

118,00

Con caño superior. Distancia a pared: 293 mm.

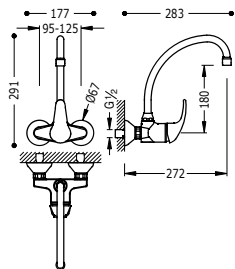

Grifo monomando mural para cocina

172218

108,00

Con caño superior. Excentricidad especial. Distancia a pared: 272 mm.

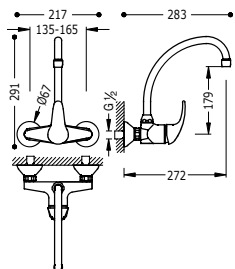

Grifo monomando mural para cocina

172418

98,00

Con caño superior. Distancia a pared: 272 mm.

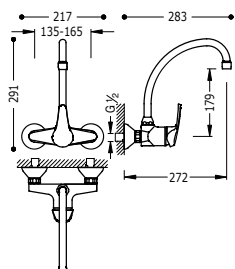

Grifo monomando mural para cocina

17031802

102,00

Con caño superior. Distancia a pared: 272 mm.



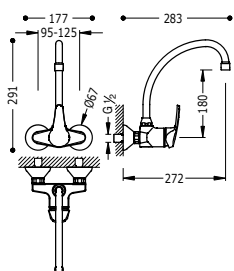

Grifo monomando mural para cocina

17021802

97,00

Con caño superior. Excentricidad especial. Distancia a pared: 272 mm.

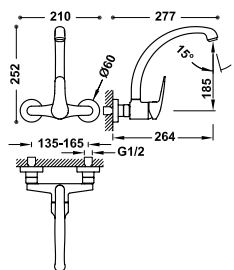

Grifo monomando mural para cocina

21642010

98,00

Con caño superior. Distancia a pared: 264 mm.



INDUSTRIALES

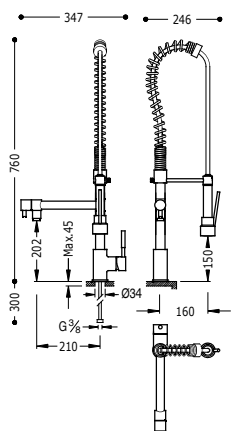

Grifo monomando doble con ducha extraíble para cocina industrial

130495

455,00

Con latiguillos de alimentación flexibles G3/8.



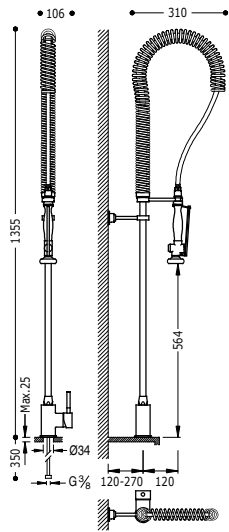

Grifo monomando con ducha extraíble para cocina industrial

130484

325,00

Con latiguillos de alimentación flexibles G3/8.

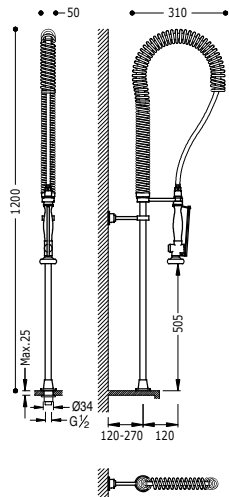

Ducha extraíble para cocina industrial con toma de agua a superficie de fregadero

130481

275,00

Sin complementos. A completar con un grifo de pedal o grifo monomando empotrado.



Grifo de pedal con mezclador de 2 aguas

112370

230,00

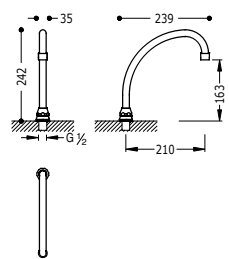

Caño giratorio para grifo de pedal

112441

40,00

Con enlace.



Grifo de pedal con mezclador de 2 aguas

112370

230,00



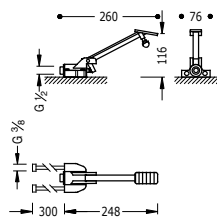

Grifo de pedal con mezclador de 2 aguas

■ 112370

230,00

Presionando el pedal aumenta progresivamente la temperatura del agua, siempre con un caudal constante.

GRIFOS PARA VARIOS USOS

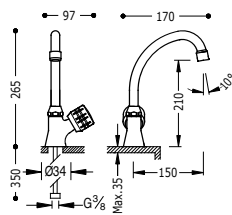

Grifo de 1 agua con volante lateral para office o lavadero

■ 123306

52,00

Con latiguillo de alimentación flexible G3/8.

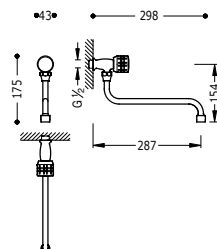

Grifo mural de 1 agua para office o lavadero

■ 123505

40,00

Con caño inferior. Distancia a pared: 287 mm.

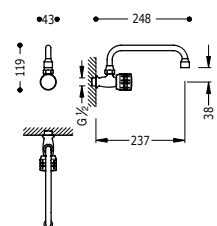

Grifo mural de 1 agua para office o lavadero

■ 123506

40,00

Con caño superior. Distancia a pared: 237 mm.







COLECTIVIDADES



468 Grifos para exterior

470 Grifos temporizados

476 Grifos medicales

477 Grifos para peluquería

478 Grifos para varios usos



GRIFOS PARA EXTERIOR

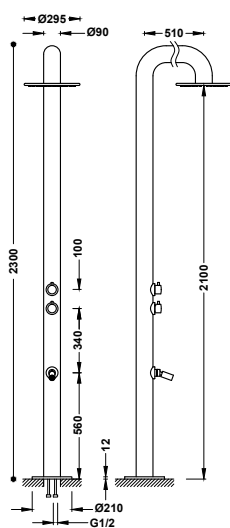

Columna de ducha para jardín o piscina de acero inoxidable 316

13499504

1.780,00

- Fabricada en acero inoxidable 316.
- Con tratamiento para exteriores que impide su deterioro.
- Con tomas de agua a suelo.
- Rociador de ducha fija Ø 295 mm. con sistema anticálcero.
- Grifo lavapiés con rótula orientable.
- Dispone de un mando para regular el caudal de ambas salidas y otro para controlar la temperatura.

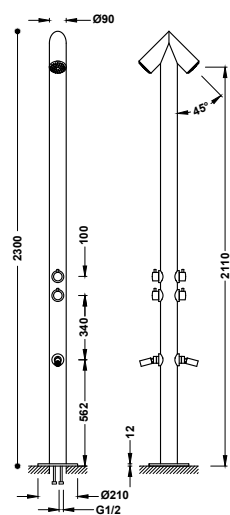
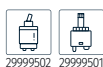

Columna con doble ducha para jardín o piscina de acero inoxidable 316

13499502

1.675,00

- Fabricada en acero inoxidable 316.
- Con tratamiento para exteriores que impide su deterioro.
- Con tomas de agua a suelo.
- Dos rociadores con sistema anticálcero.
- Dos grifos lavapiés con rótula orientable.
- Cada rociador dispone de un mando para regular el caudal de ambas salidas y otro para controlar la temperatura.

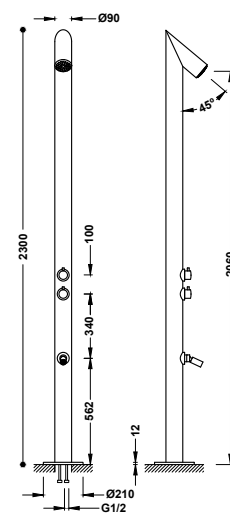

Columna de ducha para jardín o piscina de acero inoxidable 316

13499501

1.570,00

- Fabricada en acero inoxidable 316.
- Con tratamiento para exteriores que impide su deterioro.
- Con tomas de agua a suelo.
- Rociador con sistema anticálcero.
- Grifo lavapiés con rótula orientable.
- Dispone de un mando para regular el caudal de ambas salidas y otro para controlar la temperatura.



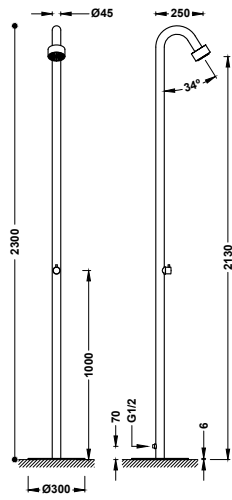

Columna de ducha de 1 agua para jardín o piscina de acero inoxidable 316

13499503

1.045,00

- Fabricada en acero inoxidable 316.
- Con tratamiento para exteriores que impide su deterioro.
- Toma de agua mediante una conexión a manguera G1/2.
- Ducha superior con sistema anticalcáreo.

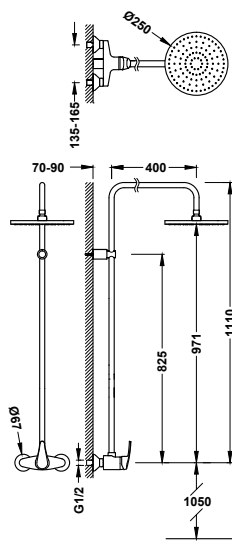

Conjunto de grifo monomando mural de 1 vía para jardín o piscina

07099501

313,00

- Rociador de ducha orientable: Ø 250 mm.

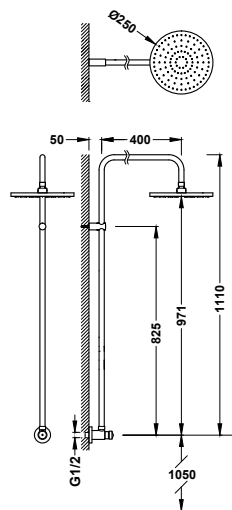

Conjunto de grifo temporizado mural de 1 agua para jardín o piscina

01299601

273,00

- Rociador de ducha orientable: Ø 250 mm.



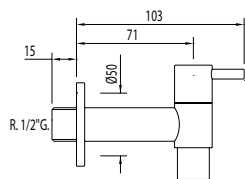

Grifo mural de 1 agua para jardín
con aireador.

03450101

26,00

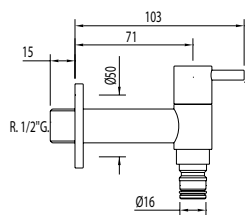

Grifo mural de 1 agua con conexión rápida a manguera

03450102

28,00

GRIFOS TEMPORIZADOS PARA LAVABO

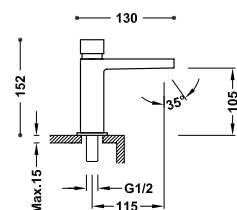

Grifo temporizado de 1 agua para lavabo
Cierre automático: 6 seg. Caudal: 0,7 l x ciclo.

20511201

119,00

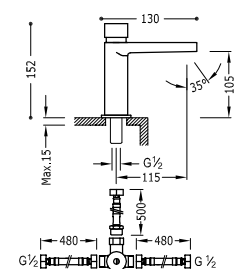

Grifo temporizado de 1 agua con sistema premezclador para lavabo
Cierre automático: 6 seg. Incluye una válvula mezcladora de 2 aguas con tubos flexibles. Caudal: 0,7 l x ciclo.

20511202

161,00

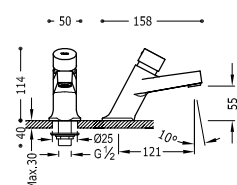

Grifo temporizado de 1 agua para lavabo
Cierre automático: 4,7 seg. Caudal: 0,4 l x ciclo.

01210303

97,00

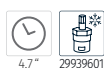

Grifo temporizado de 1 agua para lavabo
Cierre automático: 5,7 seg. Caudal: 0,5 l x ciclo.

01210302 93,00

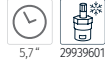
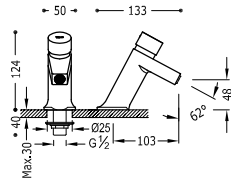

Grifo temporizado de 1 agua para lavabo
Conexión roscada macho de G1/2. Cierre automático: 4,5 seg. Caudal: 0,6 l x ciclo.

21210301 61,00

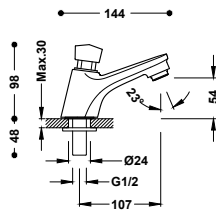

Grifo temporizado de 1 agua para lavabo
Conexión roscada macho de G1/2. Cierre automático: 10,8 seg. Caudal: 1,2 l x ciclo.

112103 103,00

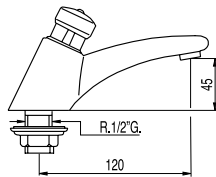

Grifo temporizado mural de 1 agua para lavabo
Conexión roscada macho de G1/2. Cierre automático: 6 seg. Caudal: 0,5 l x ciclo.

01210002 83,00

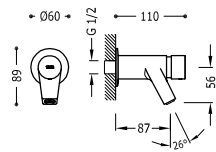

Grifo temporizado mural de 1 agua para lavabo
Conexión roscada macho de G1/2. Cierre automático: 6 seg. Caudal: 0,5 l x ciclo.

01210003 86,00

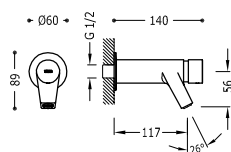

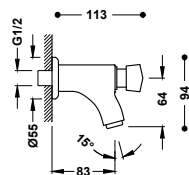

Grifo temporizado mural de 1 agua para lavabo

21210001

45,00

Conexión roscada macho de G1/2. Cierre automático: 4 seg.
Caudal: 0,8 l x ciclo.

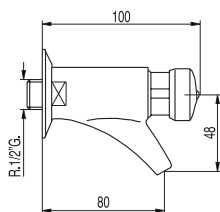

Grifo temporizado mural de 1 agua para lavabo

112100

85,00

Conexión roscada macho de G1/2. Cierre automático: 14 seg.
Caudal: 1,5 l x ciclo.



GRIFOS TEMPORIZADOS PARA URINARIO

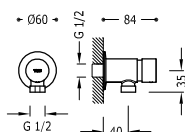

Grifo de descarga temporizado mural de 1 agua para urinario

01220002

74,00

Conexión roscada macho de G1/2. Cierre automático: 6 seg.
Caudal: 0,7 l x ciclo.

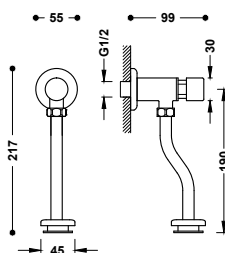

Grifo temporizado mural de 1 agua para urinario

21220001

40,00

Con un tubo adaptable al urinario. Cierre automático: 5 seg.
Caudal: 1,5 l x ciclo.

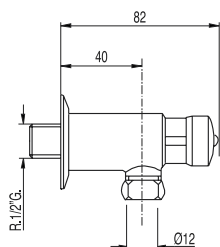

Grifo temporizado mural de 1 agua para urinario

112200

89,00

Conexión roscada macho de G1/2. Cierre automático: 4,8 seg.
Caudal: 0,9 l x ciclo.



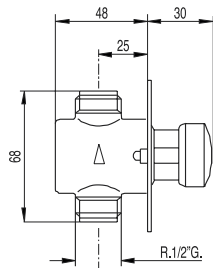

Grifo de descarga temporizado empotrado de 1 agua para urinario

01220801

80,00

Cuerpo empotrado incluido. Conexión roscada G1/2. Cierre automático: 4 seg. Caudal: 0,7 l x ciclo.

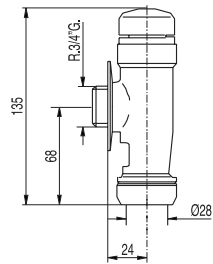

Grifo de descarga temporizado mural de 1 agua para urinario

112205

104,00

Conexión roscada macho G3/4. Salida de agua para tubo 26x28. Cierre automático: 3,5 seg. Caudal: 5,3 l x ciclo.

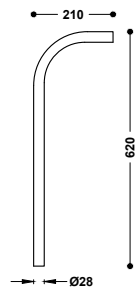

Tubo de descarga para grifo temporizado mural de urinario

13420503

66,00

GRIFOS TEMPORIZADOS PARA DUCHA

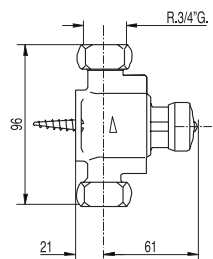

Grifo temporizado mural de 1 agua para ducha

112167

103,00

Cierre automático: 15 seg. Caudal: 16 l/min.

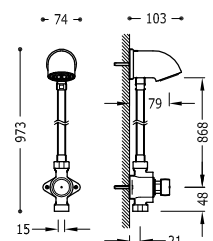

Conjunto de grifo temporizado mural de 1 agua para ducha

112161

211,00

Regulador automático de caudal incorporado en el rociador. Caudal: 8-10 l/min.



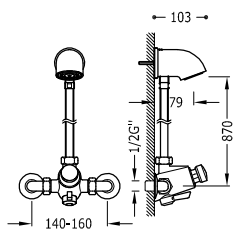

Conjunto de grifo temporizado mural con selector de temperatura para ducha

■ 112163

464,00

Regulador automático de caudal incorporado en el rociador. Caudal: 8-10 l/min. Entradas opuestas con racores extensibles y válvulas antirretorno.

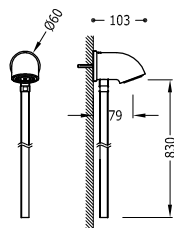

Rociador mural para ducha con tubo de conexión

■ 11216150

131,00

Con tubo de conexión. Regulador automático de caudal incorporado en el rociador. Caudal: 8-10 l/min.

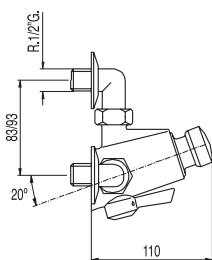

Grifo temporizado mural con selector de temperatura para ducha

■ 112162

725,00

Entradas opuestas con racores extensibles y válvulas antirretorno. Caudal: 16 l/min.

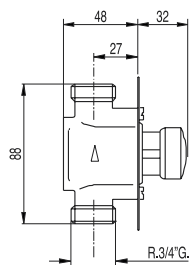

Grifo temporizado empotrado de 1 agua para ducha

■ 112178

94,00

Entrada y salida con rosca G3/4. Caudal: 20 l/min.

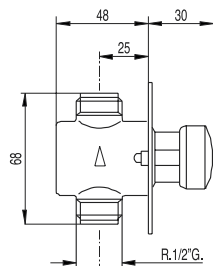

Grifo temporizado empotrado de 1 agua para ducha

■ 112177

80,00

Entrada y salida con rosca G1/2. Caudal: 16 l/min.

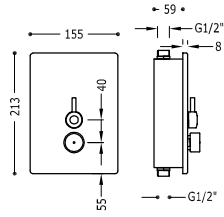

Grifo temporizado empotrado con selector de temperatura para ducha
2 entradas y 1 salida de agua con rosca G1/2.

01217901

630,00

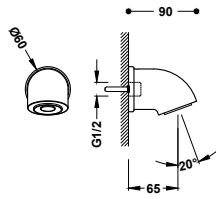

Rociador mural antivandálico para ducha

Regulador automático de caudal incorporado en el rociador.
Caudal: 6 l/min.

13416803

103,00

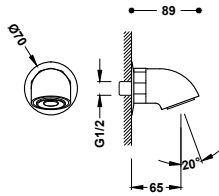

Rociador mural para ducha

Regulador automático de caudal incorporado en el rociador.
Caudal: 8-10 l/min. Conexión roscada macho G1/2.

13416703

80,00



GRIFOS MEDICALES

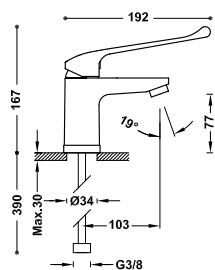

Grifo monomando medical

Con latiguillos de alimentación flexibles G3/8.

2161030111

97,00

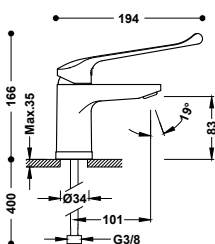

Grifo monomando medical con Cold-tres

Con latiguillos de alimentación flexibles G3/8.

2161041011BR1

100,00

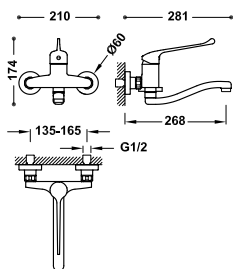
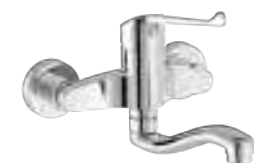

Grifo monomando medical mural

Con caño inferior. Distancia a pared: 268 mm.

2163200311

164,00

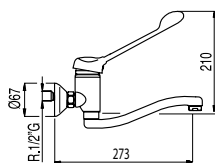

Grifo monomando medical mural

Con caño inferior. Distancia a pared: 273 mm.

17231811

200,00

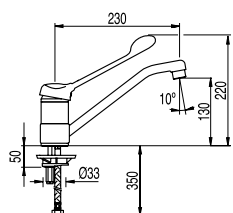

Grifo monomando medical

Con latiguillos de alimentación flexibles G3/8.

17233311

154,00



Palanca medical para grifo monomando

9134011

45,00

Para ref.: 17231811, 17233311.

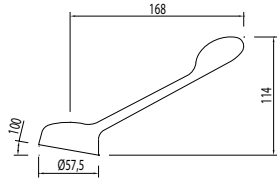

Grifo monomando medical mural para ducha

2151671011

125,00

Ducha de mano anticalcárea. Soporte articulado para ducha de mano. Flexo metálico.

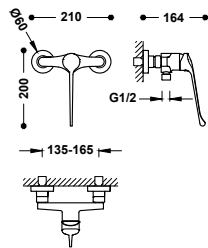

Grifo termostático mural para ducha con palancas ergonómicas

19026410

235,00

Sin complementos. Indicado para personas con discapacidades físicas.

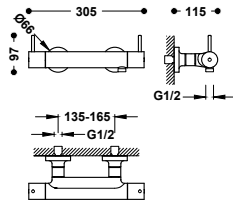

Grifo termostático mural para bañera y ducha con palancas ergonómicas

19027410

295,00

Sin complementos. Inversor integrado en el regulador de caudal. Indicado para personas con discapacidades físicas.

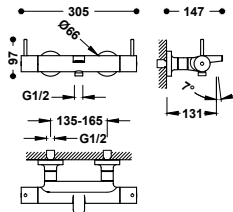

GRIFOS PARA PELUQUERÍA

Grifo monomando para lavacabezas de peluquería

172450

130,00

Con ducha de mano extraíble.

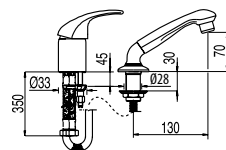

GRIFOS PARA VARIOS USOS

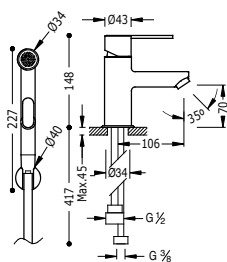

Grifo monomando para lavabo con ducha para inodoro

181113

194,00

Ducha de mano anticalcárea con cierre de caudal. Soporte fijo para ducha de mano. Flexo satinado. Latiguillos de alimentación flexibles G3/8.

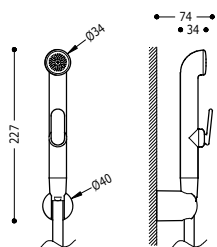

Kit de ducha para grifo monomando para inodoro

29995001

38,00

Ducha de mano con cierre de caudal. Soporte fijo para ducha de mano. Flexo satinado. Atención: Recambio solo para bidé ref: 181113.

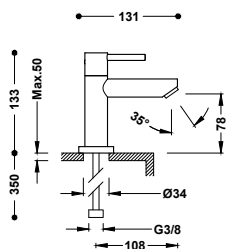

Grifo de 1 agua para lavabo

06250301

46,00

Con latiguillo de alimentación flexible G3/8.

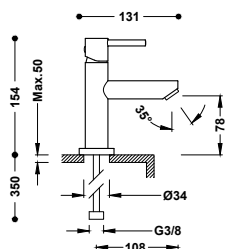

Grifo monomando para lavabo

06260301

48,00

Latiguillos de alimentación flexibles G3/8.

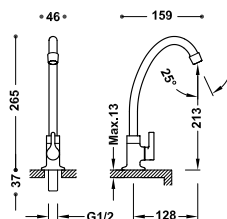

Grifo de 1 agua con maneta lateral para office o lavadero

21530601

18,00

Con conexión roscada macho de G1/2.

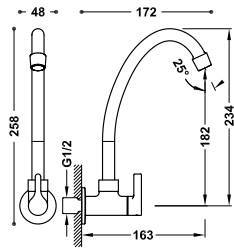

Grifo mural de 1 agua para office o lavadero
Con conexión roscada macho de G1/2.

21550601

20,00

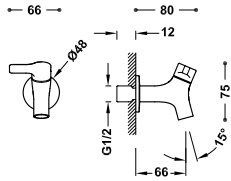

Grifo mural de 1 agua para office o lavadero
Con conexión roscada macho de G1/2. Caño de 66 mm.

21552001

16,00

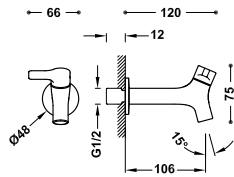

Grifo mural de 1 agua para office o lavadero
Con conexión roscada macho de G1/2. Caño de 106 mm.

21552002

20,00

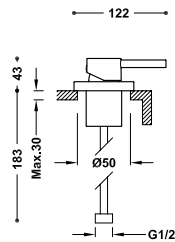

Grifo monomando de 1 vía empotrado a la superficie

03416101

80,00





COMPLEMENTOS DE GRIFERÍA

- 482 Válvulas y desagües
- 491 Sifones
- 495 Llaves de paso
- 497 Conexiones acodadas
- 499 Caños
- 501 Florones
- 502 Excéntricas
- 504 WC SYSTEMS
- 506 Mecanismos de llenado
- 507 Mecanismos de descarga
- 510 TRES CLEANER
- 513 Limpiador de grifería



VÁLVULAS SIMPLE-RAPID PARA LAVABO

Válvula de desagüe Click-clack Simple-rapid para lavabo

Apto para lavamanos con y sin rebosadero. Función Click-clack. Tapón Ø 63 mm. Simple-rapid fácil instalación.

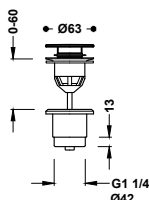

24284001	49,00
24284001NM	76,00
24284001BM	76,00
24284001AC	76,00
24284001KM	76,00
24284001KMB	76,00
24284001OR	108,00
24284001OM	108,00
24284001OP	108,00
24284001OPM	108,00
24284001LV	71,00
24284001LM	71,00
24284001AM	76,00
24284001RO	76,00
24284001NE	76,00
24284001BL	76,00

Válvula de desagüe Click-clack Simple-rapid para lavabo

Apto para lavamanos con y sin rebosadero. Función Click-clack. Tapón Ø 40 mm. Simple-rapid fácil instalación.

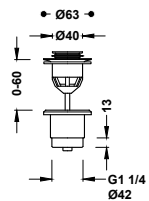

24284002	46,00
24284002NM	71,00
24284002BM	71,00
24284002AC	71,00
24284002KM	71,00
24284002KMB	71,00
24284002OR	101,00
24284002OM	101,00
24284002OP	101,00
24284002OPM	101,00
24284002LV	66,00
24284002LM	66,00
24284002NE	71,00
24284002BL	71,00

Válvula de desagüe Click-clack Simple-rapid para lavabo con opción siempre abierta

Incluye un adaptador que da la opción para que el tapón siempre quede abierto. Apto para lavamanos con y sin rebosadero.

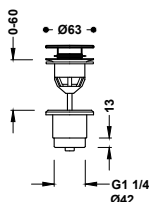

24284010	52,00
24284010NM	81,00
24284010BM	81,00
24284010AC	81,00
24284010KM	81,00
24284010KMB	81,00
24284010OR	114,00
24284010OM	114,00
24284010OP	114,00
24284010OPM	114,00
24284010LV	75,00
24284010LM	75,00
24284010AM	81,00
24284010RO	79,00
24284010NE	81,00
24284010BL	81,00

Válvula de desagüe Click-clack Simple-rapid para lavabo con opción siempre abierta

Incluye un adaptador que da la opción para que el tapón siempre quede abierto. Apto para lavamanos con y sin rebosadero.

■ 24284020	49,00
■ 24284020NM	76,00
■ 24284020BM	76,00
■ 24284020AC	76,00
■ 24284020KM	76,00
■ 24284020KMB	76,00
■ 24284020OR	107,00
■ 24284020OM	107,00
■ 24284020OP	107,00
■ 24284020OPM	107,00
■ 24284020LV	71,00
■ 24284020LM	71,00
■ 24284020NE	76,00
■ 24284020BL	76,00

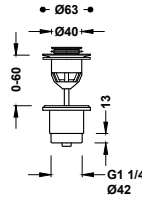

Válvula de desagüe Click-clack Simple-rapid para lavabo

Apto para lavamanos con y sin rebosadero. Función Click-clack. Tapón: Ø 63,5 mm. Simple-rapid fácil instalación.

■ 161840	44,00
----------	-------

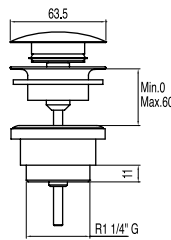

Válvula de desagüe Click-clack Simple-rapid para lavabo

Apto para lavamanos con y sin rebosadero. Función Click-clack. Tapón: 68x68 mm. Simple-rapid fácil instalación.

■ 13434010	30,00
------------	-------

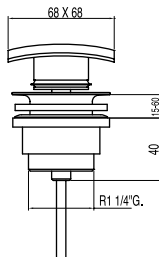

Válvula de desagüe Click-clack Simple-rapid para lavabo

Apto para lavamanos con y sin rebosadero. Función Click-clack. Tapón: Ø 40 mm. Simple-rapid fácil instalación.

■ 162840	34,00
----------	-------

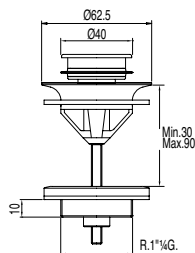

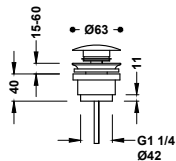

Válvula de desagüe Click-clack Simple-rapid para lavabo

■ 13454010

25,00

Apto para lavamanos con y sin rebosadero. Función Click-clack. Tapón: Ø 63 mm. Simple-rapid fácil instalación.

VÁLVULAS PARA LAVABO SIN REBOSADERO

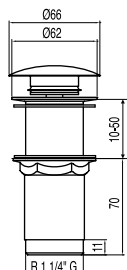

Válvula de desagüe Click-clack para lavabo sin rebosadero

■ 13454060

25,00

Sin rebosadero. Función Click-clack. Tapón: Ø 66 mm.

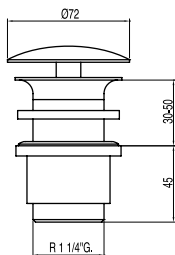

Válvula de desagüe siempre abierto para lavabo sin rebosadero

■ 13424020

29,00

Sin rebosadero. Tapón: Ø 72 mm.

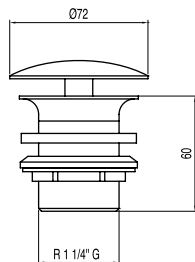

Válvula de desagüe siempre abierto para lavabo sin rebosadero

■ 13424010

23,00

Sin rebosadero. Tapón: Ø 72 mm.

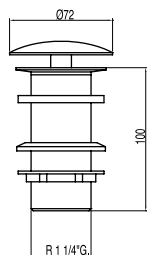

Válvula de desagüe siempre abierto para lavabo sin rebosadero

■ 13424030

24,00

Sin rebosadero. Tapón: Ø 72 mm.

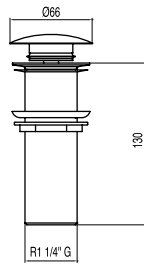

Válvula de desagüe Click-clack para lavabo sin rebosadero

13454030

38,00

Sin rebosadero. Función Click-clack. Tapón: Ø 66 mm.

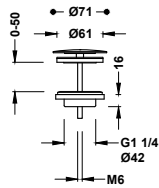

Válvula de desagüe siempre abierto para lavabo sin rebosadero

134215028

19,00

Sin rebosadero. Tapón: Ø 71 mm.

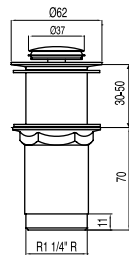

Válvula de desagüe Click-clack para lavabo sin rebosadero

13454050

22,00

Sin rebosadero. Función Click-clack. Tapón: Ø 37 mm.

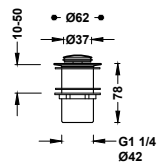

Válvula de desagüe Click-clack para lavabo sin rebosadero

13454070

18,00

Sin rebosadero. Función Click-clack. Tapón: Ø 37 mm.

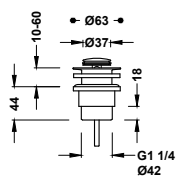

Válvula de desagüe Click-clack para lavabo sin rebosadero

134215026

13,00

Sin rebosadero. Función Click-clack. Tapón: Ø 37 mm.



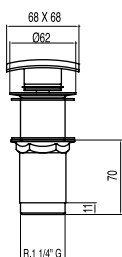

Válvula de desagüe Click-clack para lavabo sin rebosadero
 Sin rebosadero. Función Click-clack. Tapón: 68x68 mm.

■ 13434120 30,00

VÁLVULAS PARA LAVABO CON REBOSADERO

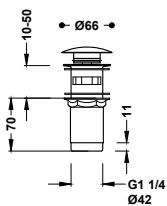

Válvula de desagüe Click-clack para lavabo con rebosadero
 Con rebosadero. Función Click-clack. Tapón: Ø 66 mm.

■ 13454160 25,00

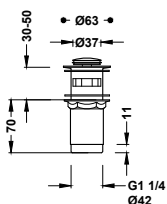

Válvula de desagüe Click-clack para lavabo con rebosadero
 Con rebosadero. Función Click-clack. Tapón: Ø 37 mm.

■ 13454110 22,00

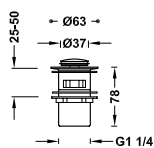

Válvula de desagüe Click-clack para lavabo con rebosadero
 Con rebosadero. Función Click-clack. Tapón: Ø 37 mm.

■ 13454190 18,00

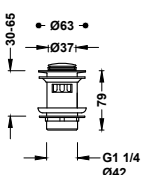

Válvula de desagüe Click-clack para lavabo con rebosadero
 Con rebosadero. Función Click-clack. Tapón: Ø 37 mm.

■ 134215025 19,00

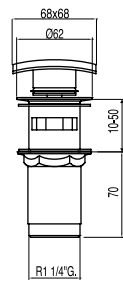

Válvula de desagüe Click-clack para lavabo con rebosadero
 Con rebosadero. Función Click-clack. Tapón: 68x68 mm.

■ 13434020

30,00

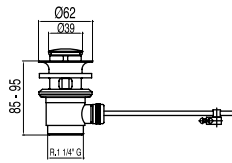

Válvula de desagüe automático para lavabo con rebosadero
 Con rebosadero. Tapón: Ø 39 mm.

■ 13474310

18,00

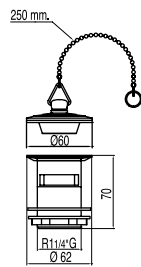

Válvula de desagüe con tapón y cadenilla para lavabo con rebosadero
 Cadenilla de 250 mm.

■ 13474320

17,00

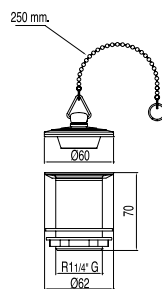

Válvula de desagüe con tapón y cadenilla para lavabo sin rebosadero
 Cadenilla de 250 mm.

■ 13474330

17,00

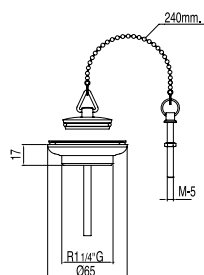

Cazoleta plana de desagüe con kit de enganche de cadenilla y tapón para lavabo, bidé y fregadero
 Cadenilla de 240 mm.

■ 13463910

13,00



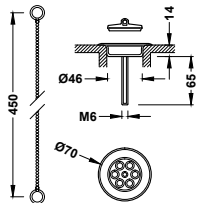

Cazoleta plana de desagüe con cadenilla y tapón para lavabo, bidé y fregadero

Cadenilla: 450 mm. Cazoleta: Ø 70 mm. Tapón metálico.

03474601	32,00
03474601AC	50,00
03474601OR	70,00
03474601OM	70,00
9134746051	46,00
03474601LM	46,00

COMPLEMENTOS PARA VÁLVULAS

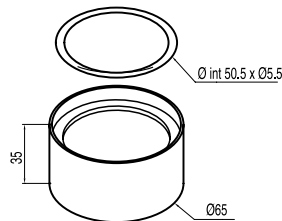

Separador para válvula de desagüe

Para lavamanos de sobre-encimera. Diámetro: Ø 65 mm. Altura: 35 mm.

916110348	36,00
-----------	-------

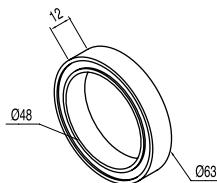

Separador para válvula de desagüe

Para lavamanos de sobre-encimera. Diámetro: Ø 63 mm. Altura: 12 mm.

13463310	14,00
----------	-------

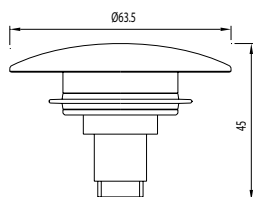

Tapón para válvula de desagüe Click-clack

Función Click-clack. Tapón: Ø 63.5 mm. Para ref.: 161840.

916184060	28,00
-----------	-------

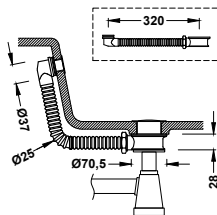

Adaptador para lavamanos de cristal o acero inoxidable que no poseen rebosadero

Con rebosadero. Tubo flexible: 320 mm.

13463450	23,00
----------	-------

DESAGÜES PARA DUCHA O BAÑERA

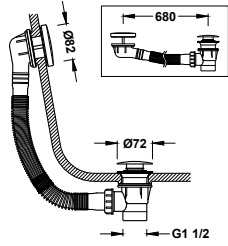

Válvula de desagüe Click-clack con rebosadero para bañera

Tapón: Ø 72 mm. Tubo flexible: máx. 680 mm.

13453420	32,00
03453420NM	50,00
03453420BM	50,00
03453420AC	50,00
03453420KM	50,00
03453420KMB	50,00
03453420OR	70,00
03453420OM	70,00
03453420OP	70,00
03453420OPM	70,00
03453420LV	46,00
03453420LM	46,00

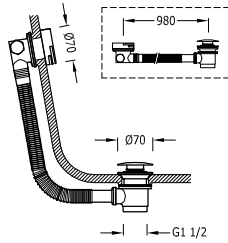

Válvula de desagüe redondo Click-clack y de llenado con rebosadero para bañera

Tapón: Ø 70 mm. Tubo flexible: máx. 980 mm.

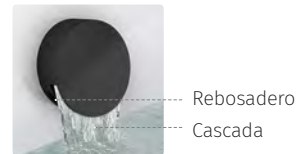

13453430	69,00
03453430NM	107,00
03453430BM	107,00
03453430AC	107,00
03453430KM	107,00
03453430KMB	107,00
03453430OR	152,00
03453430OM	152,00
03453430OP	152,00
03453430OPM	152,00
03453430LV	100,00
03453430LM	100,00

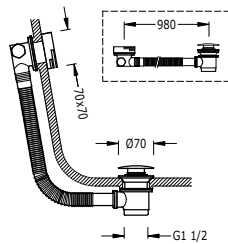

Válvula de desagüe cuadrado Click-clack y de llenado con rebosadero para bañera

Tapón: Ø 70 mm. Tubo flexible: máx. 980 mm.



13453440	95,00
03453440NM	146,00
03453440AC	146,00
03453440OR	208,00
03453440OM	208,00

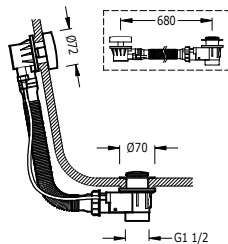

Válvula de desagüe automático para bañera con rebosadero

Con rebosadero. Se puede abrir y cerrar la válvula de desagüe girando el volante situado sobre el desagüero. Tapón: Ø 43 mm. Tubo flexible: máx. 680 mm.

13453410	35,00
----------	-------



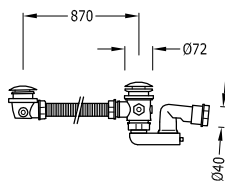

Válvula de desagüe Click-clack para bañera con rebosadero y toma de drenaje

134445

100,00

Con toma de drenaje de agua para kit de depósito. Tapón Ø 72 mm.

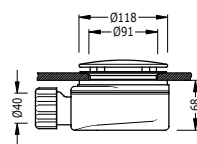

Desagüe sifónico inspeccionable para plato de ducha

104841

42,00

Con sifón incorporado. Tapón: Ø 118 mm. Volumen de desagüe: 62 l/min.

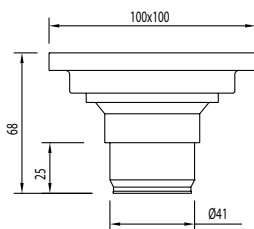

Sumidero inspeccionable para plato de ducha de obra

03474007

25,00

No requiere de sifón. Material: Latón.

IDEAL PARA PLATOS DE DUCHA DE OBRA

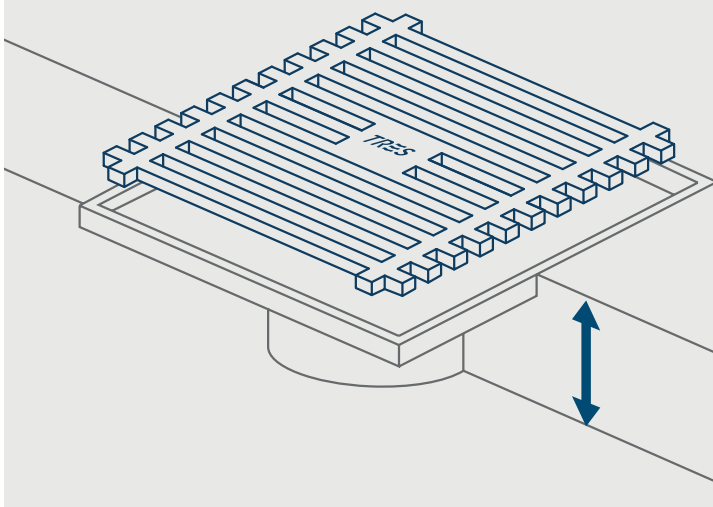

- Mínima profundidad
- No requiere de sifón
- Elimina malos olores
- Inspeccionable
- Fabricado en latón

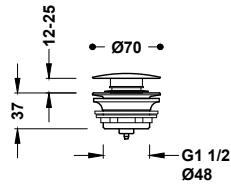

Válvula de desagüe Click-clack para bañera
Función Click-clack. Tapón: Ø 70 mm.

13474010	20,00
13474010NM	31,00
13474010BM	31,00
13474010AC	31,00
13474010KM	31,00
13474010KMB	31,00
13474010OR	44,00
13474010OM	44,00
13474010OP	44,00
13474010PM	44,00

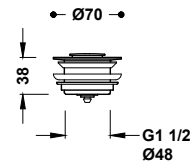

Válvula de desagüe Click-clack con tapón oculto para bañera
Función Click-clack. Tapón: Ø 36 mm.

134215027	14,00
-----------	-------

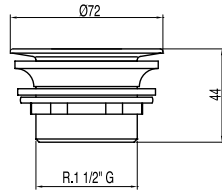

Desagüe para lavadero o similar
Tapón: Ø 72 mm.

13474020	9,00
----------	------

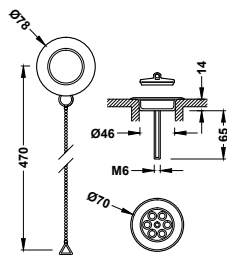

Cazoleta plana de desagüe con kit de enganche de cadenilla y tapón para bañera
Cadenilla: 450 mm. Cazoleta: Ø 70 mm. Tapón metálico.

03474501	40,00
03474501AC	62,00
03474501OR	104,00
03474501OM	104,00
9134745051	58,00
03474501LM	58,00

SIFONES

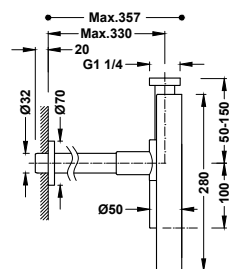

Sifón telescópico cuadrado inspeccionable con faldón para lavabo

10710342	200,00
10710342NM	310,00
10710342BM	310,00
10710342AC	310,00
10710342KM	310,00
10710342KMB	310,00
10710342OR	440,00
10710342OM	440,00
10710342OP	440,00
10710342OPM	440,00

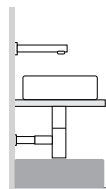

Sifón telescópico redondo inspeccionable con faldón para lavabo

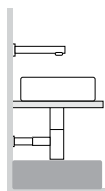
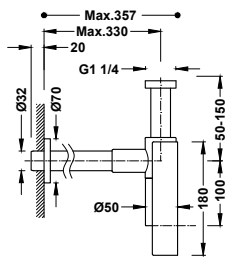

16110342	170,00
16110342NM	264,00
16110342BM	264,00
16110342AC	264,00
16110342KM	264,00
16110342KMB	264,00
16110342OR	374,00
16110342OM	374,00
16110342OP	374,00
16110342OPM	374,00

Sifón telescópico tipo botella inspeccionable para lavabo

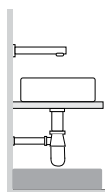
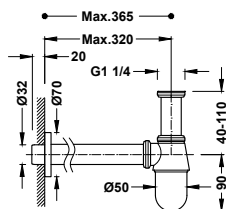

13463430	32,00
03463430NM	74,00
03463430BM	74,00
03463430AC	74,00
03463430KM	74,00
03463430KMB	74,00
03463430OR	198,00
03463430OM	198,00
03463430OP	198,00
03463430OPM	198,00
03463430LV	74,00
03463430LM	74,00

Sifón telescópico con registro para lavabo

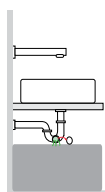
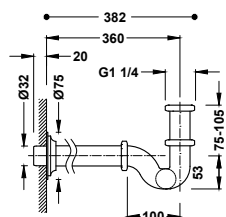

13463820	34,00
03463820NM	78,00
03463820BM	78,00
03463820AC	78,00
03463820KM	78,00
03463820KMB	78,00
03463820OR	211,00
03463820OM	211,00
03463820OP	211,00
03463820OPM	211,00
03463820LV	78,00
03463820LM	78,00

Sifón telescópico acodado para lavabo

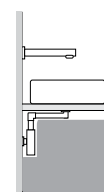
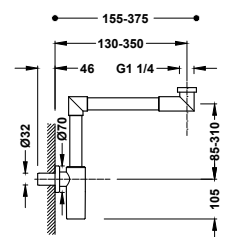

16110362	181,00
----------	--------

Sifón telescópico para lavabo

■ 13463420 63,00
■ 13463420NM 98,00

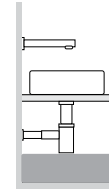
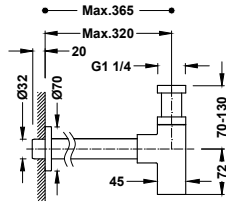

Sifón telescópico para lavabo

■ 13463410 43,00
■ 13463410NM 67,00

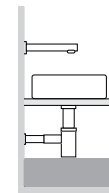
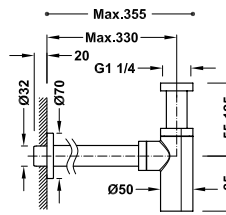

Sifón telescópico giratorio para lavabo

Tubo de salida giratorio. Ideal para cualquier instalación.

■ 13463810 22,00

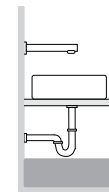
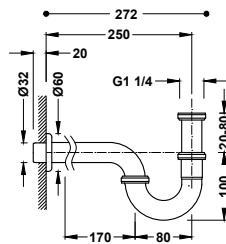

Sifón telescópico giratorio para lavabo

Tubo de salida giratorio. Ideal para cualquier instalación.

■ 134215024 16,00

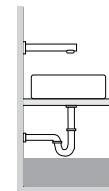
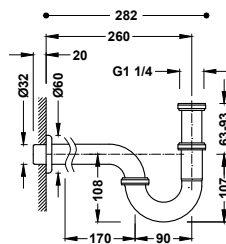

Sifón telescópico tipo botella inspeccionable para bidé

■ 13463440 23,00

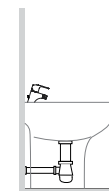
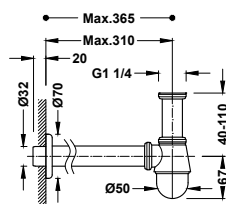

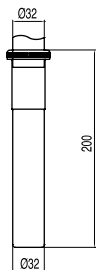

Alargadera para sifón telescópico tipo botella

Longitud: 200 mm.

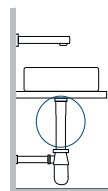

- 913463320 15,00
- 913463320NM 23,00 **N**
- 913463320BM 23,00 **N**
- 913463320AC 23,00 **N**
- 913463320KM 23,00 **N**
- 913463320KMB 23,00 **N**
- 913463320OR 52,00 **N**
- 913463320OM 52,00 **N**
- 913463320OP 52,00 **N**
- 913463320OPM 52,00 **N**
- 913463320LV 22,00 **N**
- 913463320LM 22,00 **N**

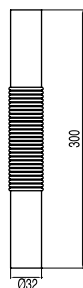

Tubo flexible corrugado para sifón telescópico tipo botella

Longitud: 300 mm.

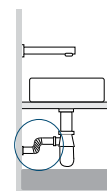

- 913463330 12,00

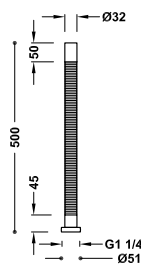

Tubo flexible coarrugado para desagüe

- 913463250 18,00

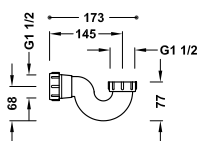
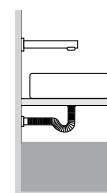

Sifón de PVC para bañera

- 13463460 5,00

LLAVES DE PASO

Llave de escuadra con filtro
R.1/2" - R.3/8"

9134525 16,00
9134525NM 25,00

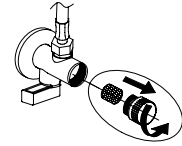
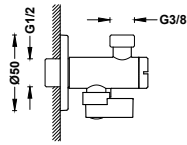

Llave de escuadra con filtro
R.1/2" - R.1/2"

29952505 16,00

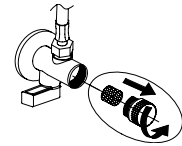
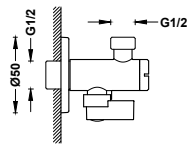

Llave de escuadra

13474220 16,00

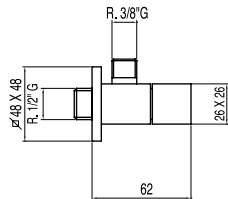

Llave de escuadra

13474210 13,00

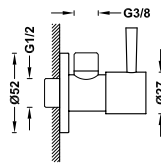

Llave de paso empotrada
Conexión a rosca hembra: 1/2".

00715501 89,00
00715501NM 137,00
00715501BM 137,00
00715501AC 137,00
00715501OR 196,00
00715501OM 196,00

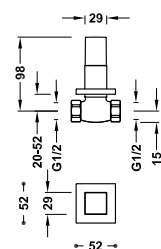



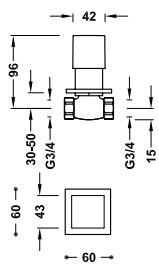

Llave de paso empotrada
Conexión a rosca hembra: 3/4".

107511 **96,00**



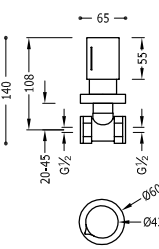

Llave de paso empotrada
Conexión a rosca hembra: 1/2".

06115501	83,00
06115501NM	128,00
06115501BM	128,00
06115501AC	128,00
06115501KM	128,00
06115501KMB	128,00
06115501OR	182,00
06115501OM	182,00
06115501OP	182,00
06115501OPM	182,00



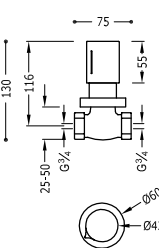

Llave de paso empotrada
Conexión a rosca hembra: 3/4".

06151101	91,00
06151101NM	140,00
06151101BM	140,00
06151101AC	140,00
06151101KM	140,00
06151101KMB	140,00
06151101OR	199,00
06151101OM	199,00
06151101OP	199,00
06151101OPM	199,00



Alargadera para llave de paso

29915501 **37,00**

N



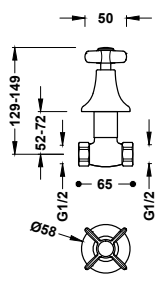

Llave de paso empotrada
Con conexión roscada de G1/2. Índice cerámico (frío).

24215501	93,00
24215501AC	145,00
24215501OR	206,00
24215501LV	136,00
24215501LM	136,00



29910501

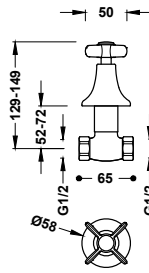

Llave de paso empotrada

Con conexión roscada de G1/2. Índice cerámico (caliente).

24215502	93,00
24215502AC	145,00
24215502OR	206,00
24215502LV	136,00
24215502LM	136,00



29910501

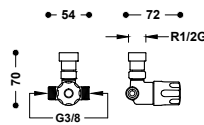

Válvula mezcladora de agua caliente-fría

Apto para hacer llegar agua premezclada a un grifo de 1 agua de lavabo y cocina.

29944601	55,00
----------	-------

CONEXIONES ACODADAS

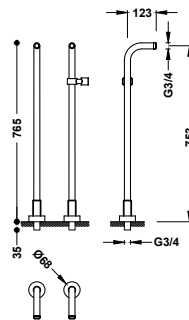

Tomas de agua acodadas de instalación a suelo para grifo de bañera

2 unidades con soporte fijo para ducha de mano.

161194	310,00
161194NM	481,00
161194AC	481,00
161194OM	682,00
161194OPM	682,00

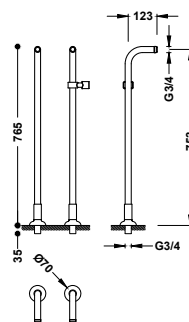

Tomas de agua acodadas de instalación a suelo para grifo de bañera

2 columnas verticales de alimentación de agua a suelo.

24219403	350,00
24219403AC	543,00
24219403OM	770,00
24219403LV	508,00
24219403LM	508,00

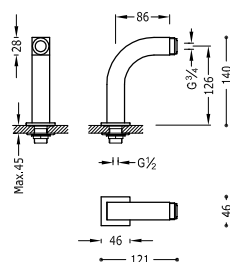

Tomas de agua acodadas de instalación a borde bañera para grifo de bañera

2 unidades con silenciador.

29987002	126,00
----------	--------



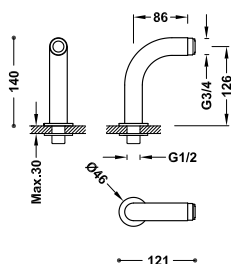

Tomas de agua acodadas de instalación a borde bañera para grifo de bañera

2 unidades con silenciador.

29987001	114,00
29987001NM	177,00
29987001AC	177,00
29987001OM	251,00
29987001OPM	251,00

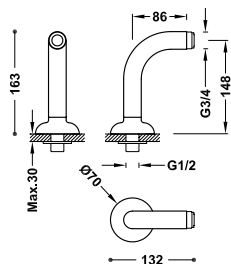

Tomas de agua acodadas de instalación a borde bañera para grifo de bañera

2 unidades con silenciador.

24287101	154,00
24287101AC	239,00
24287101OR	339,00
24287101LV	223,00
24287101LM	223,00

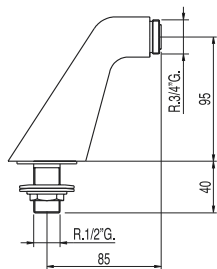

Tomas de agua acodadas de instalación a borde bañera para grifo de bañera

2 unidades con silenciador.

134871	102,00
--------	--------

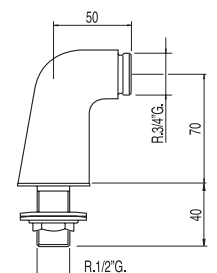

Tomas de agua acodadas de instalación a borde bañera para grifo de bañera

2 unidades con silenciador.

134870	89,00
--------	-------

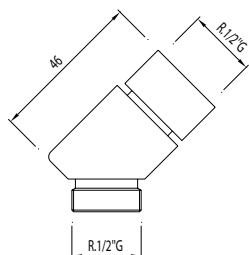

Conexión acodada universal para ducha de mano

Apto para bañeras de repisa. Para ref.: 14150, 61150, 62150, 63145, 61161, 87150, 87161, 89150, 89161.

913414580	43,00
-----------	-------

CAÑOS

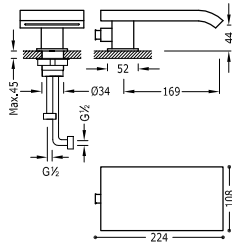

Caño fijo para borde bañera con salida en cascada

18718250 368,00

Caño cerrado con salida del agua en cascada. Inversor integrado en el caño.

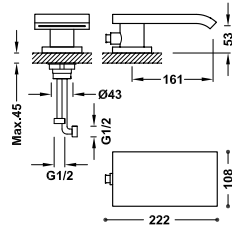

Caño fijo para borde bañera con salida en cascada

16216150 315,00

Caño cerrado con salida del agua en cascada. Inversor integrado en el caño.

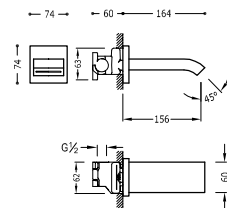

Caño fijo de pared con salida en cascada

107181 200,00

Caño cerrado con salida del agua en cascada. Con toma de agua a pared regulable en profundidad. Cuerpo empotrado incluido.

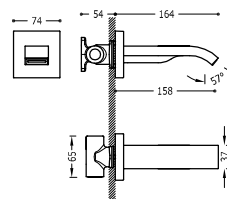

Caño fijo de pared con salida en cascada

- 20718107 160,00
- 20718107NM 248,00
- 20718107BM 248,00
- 20718107AC 248,00
- 20718107OR 352,00
- 20718107OM 352,00

Caño cerrado con salida del agua en cascada. Con toma de agua a pared regulable en profundidad. Cuerpo empotrado incluido.

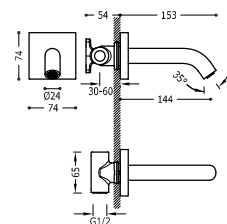

Caño fijo de pared

- 21018107 102,00
- 21018107NM 158,00
- 21018107BM 158,00
- 21018107AC 158,00
- 21018107KM 158,00
- 21018107KMB 158,00
- 21018107OR 224,00
- 21018107OM 224,00
- 21018107OP 224,00
- 21018107OPM 224,00

Con toma de agua a pared regulable en profundidad. Cuerpo empotrado incluido.



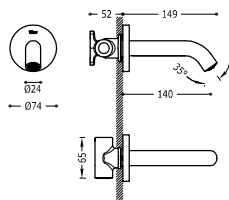

Caño fijo de pared

Con toma de agua a pared regulable en profundidad. Cuerpo empotrado incluido.

- 26218004 102,00
- 26218004NM 158,00
- 26218004BM 158,00
- 26218004AC 158,00
- 26218004KM 158,00
- 26218004KMB 158,00
- 26218004OR 224,00
- 26218004OM 224,00
- 26218004OP 224,00
- 26218004OPM 224,00

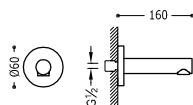

Caño fijo de pared

Con toma de agua roscada G1/2. Longitud: 160 mm. No es un recambio. No es compatible con cuerpos empotrados indivisibles.

- 16117002 102,00

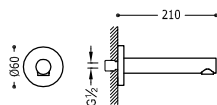

Caño fijo de pared

Con toma de agua roscada G1/2. Longitud: 210 mm. No es un recambio. No es compatible con cuerpos empotrados indivisibles.

- 06117202 108,00

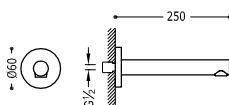

Caño fijo de pared

Con toma de agua roscada G1/2. Longitud: 250 mm. No es un recambio. No es compatible con cuerpos empotrados indivisibles.

- 16117102 116,00

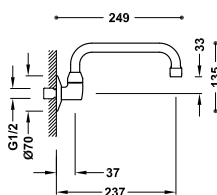

Caño giratorio de pared

Tipo tubo. Longitud: 237 mm.

- 134302 55,00



Caño giratorio de pared

134303

59,00

Tipo tubo. Longitud: 287 mm.

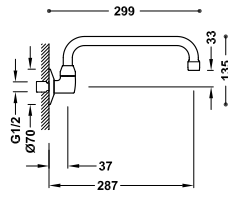

FLORONES

Florón cuadrado

913474410

6,00

Material: Latón.

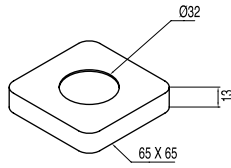

Florón redondo

913474430

9,00

Material: Latón.

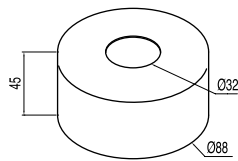

Florón redondo

913474420

6,00

Material: Latón.

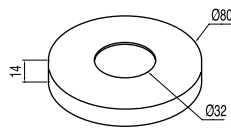

Florón para excéntricas especiales

9134781

6,00

Material: Latón. Ø 70 mm.

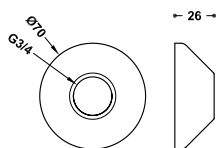

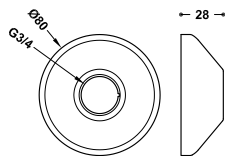

Florón para excéntricas especiales

Material: Latón. Ø 80 mm.

9134784

8,00

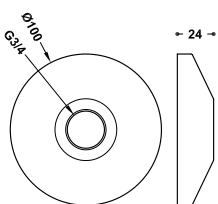

Florón para excéntricas especiales

Material: Latón. Ø 100 mm.

9134788

12,00

EXCÉNTRICAS



Excéntrica con silenciador para desplazar la toma de la grifería

Conexión roscada macho: 1/2". Desplazamiento: 7,5 mm. 13,5 - 16,5 mm.

9134779

10,00

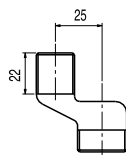

Excéntrica con silenciador para desplazar la toma de la grifería

Conexión roscada macho: 1/2". Desplazamiento: 25 mm. 10 - 20 mm.

9134780

14,00

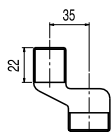

Excéntrica para desplazar la toma de la grifería

Conexión roscada macho: 1/2". Desplazamiento: 35 mm. 8 - 22 mm. Compatible con el florón ref.: 9134788

9134787

13,00

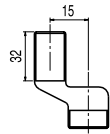

Excéntrica con silenciador para desplazar la toma de la grifería

9134786

12,00

Conexión roscada macho: 1/2". Desplazamiento: 15 mm. 12 -18 mm.

VÁLVULA TERMOSTÁTICA

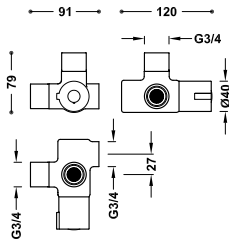

Válvula termostática para el calentador

20725001

160,00

- Filtros en las entradas de agua.
- Con válvulas antirretorno en las entradas de agua.
- Ideal para espacios públicos donde queremos temperatura constante.

- Cuerpo de latón.
- Reduce el consumo de energía y agua en circuitos de recirculación.
- Aumenta el volumen de agua caliente ya que a la salida del calentador añadimos agua fría.
- Seguridad: evita quemaduras causadas por el agua caliente.

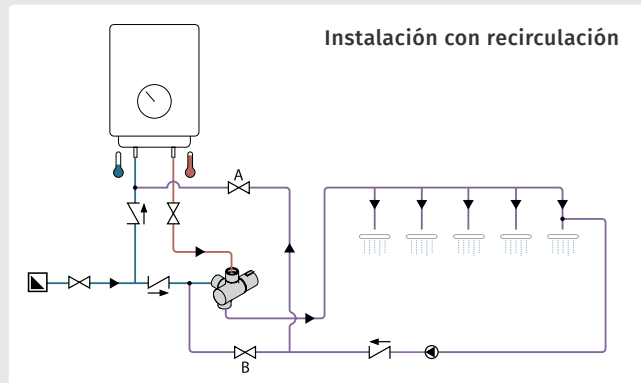
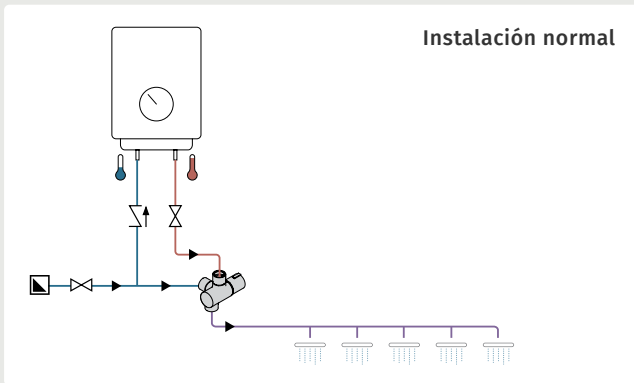



WC SYSTEMS

Tres ofrece mecanismos para la cisterna de wáter como una alternativa económica y de calidad en estos elementos presentes en un cuarto de baño. Distintos mecanismos de llenado y de vaciado con un funcionamiento e instalación similar pero con características particulares para resolver las distintas necesidades de cada tipo de cisterna.



MECANISMOS DE LLENADO

Mecanismo de llenado para cisterna de inodoro

25477001

13,00

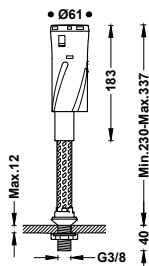

- Monobloc de llenado inferior.
- Entrada de agua G3/8 con racord de latón.
- Con ajuste de nivel de agua fácil y rápido.
- Con filtro de fácil acceso.
- Extra silencioso. Solo 16 db.
- Llenado rápido: 5,2 l. (5 bars)
- Regulación superior.

Mecanismo de llenado para cisterna de inodoro

25477007

14,00

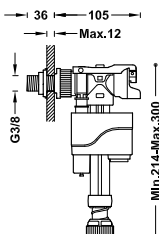

- De llenado inferior o lateral.
- Entrada de agua lateral o inferior intercambiando el racord de latón.
- Entrada de agua G3/8 racord de latón.
- Filtro en la entrada de agua.
- Con ajuste de nivel de agua fácil y rápido.
- Regulación superior.

Mecanismo de llenado para cisterna de inodoro

25477002

12,00

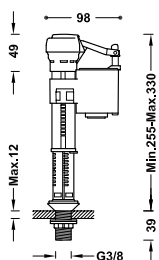

- De llenado inferior.
- Entrada de agua G3/8 con racord de latón.
- Filtro en la entrada de agua.
- Con ajuste de nivel de agua.
- Regulación superior.

Mecanismo de llenado para cisterna de inodoro

25477004

9,00

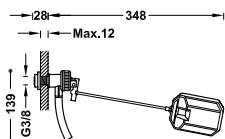

- De llenado lateral.
- Sujeción de la boya con varilla de latón.
- Entrada de agua G3/8 racord de latón.
- Filtro en la entrada de agua.

Mecanismo de llenado para cisterna de inodoro

25477003

10,00

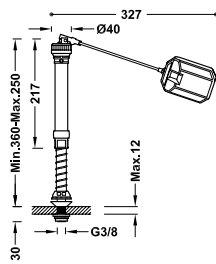

- De llenado inferior.
- Sujeción de la boya con varilla de latón.
- Entrada de agua G3/8 record de latón.
- Filtro en la entrada de agua.
- Con ajuste de nivel de agua.

MECANISMOS DE DESCARGA

Mecanismo de descarga para cisterna de inodoro

25477012

13,00

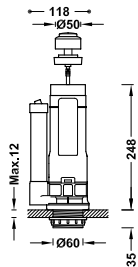

- Descarga única.
- Accionamiento superior.
- Mecanismo universal con pulsador.
- Botón de descarga única.
- Ajuste de la altura del rebosadero.
- Rango de ajuste para la descarga.
- Con junta de silicona.

Mecanismo de descarga para cisterna de inodoro

25477009

16,00

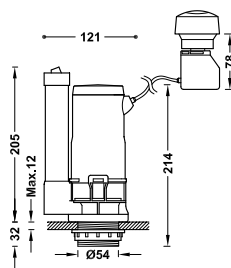

- Doble descarga.
- Accionamiento superior o lateral.
- Mecanismo universal con doble pulsador.
- Botón de descarga total y botón de descarga parcial.
- Ajuste de la altura del rebosadero.
- Con junta de silicona.

Mecanismo de descarga para cisterna de inodoro

25477005

14,00

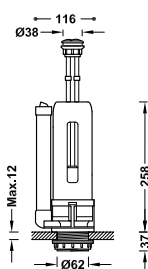

- Doble descarga.
- Accionamiento superior.
- Mecanismo universal con doble pulsador.
- Botón de descarga total y botón de descarga parcial.
- Velocidad de descarga rápida.
- Con junta de silicona.



		<p>Junta de conexión Material: Foam. Dimensiones: 106x65x16 mm.</p>	<p>25477006</p>	<p>3,00</p>
		<p>Junta de silicona Dimensiones: 65x42x2 mm.</p>	<p>25477010</p>	<p>3,00</p>
		<p>Tornillos de fijación de cisterna a inodoro</p>	<p>25477008</p>	<p>5,00</p>
		<p>Varilla roscada 2 unidades</p>	<p>25477011</p>	<p>4,00</p>
		<p>Tapón para la cisterna</p>	<p>25477013</p>	<p>4,00</p>



Conjunto completo de mecanismo de llenado para cisterna de inodoro

25477091

39,00

- 25477001 - Mecanismos de llenado
- 25477009 - Mecanismos de descarga
- 25477006 - Junta de conexión
- 25477008 - Tornillos de fijación de cisterna
- 25477013 - Tapón para la cisterna



Conjunto completo de mecanismo de llenado para cisterna de inodoro

25477092

40,00

- 25477007 - Mecanismos de llenado
- 25477009 - Mecanismos de descarga
- 25477006 - Junta de conexión
- 25477008 - Tornillos de fijación de cisterna
- 25477013 - Tapón para la cisterna





TRES CLEANER

Tres Cleaner es un spray limpiador para grifería de baño y cocina testado para los productos Tres. Doble función para eliminar la suciedad y mantener el acabado de la grifería. El limpiador de grifería funciona pulverizando la zona a lavar, dejándolo actuar brevemente, aclarando con agua tibia y secándolo con un paño suave.



TRES CLEANER

Lo más recomendado para limpiar las superficies metálicas y brillantes de los grifos



Abrillanta las superficies



Elimina las huellas



Repele la suciedad
Elimina la cal



Efecto antiestático



Con la boquilla abierta se dispersa el líquido con un pulverizador fino que llega a áreas más grandes, como mamparas y espejos.



Con la boquilla cerrada, la espuma limpiadora activa se adhiere y actúa significativamente más sobre la suciedad y permite una limpieza más profunda.



LIMPIADOR DE GRIFERÍA



Tres Cleaner. Limpiador de grifería para baño y cocina

134100106

16,00

- Abrillanta las superficies.
- Elimina las huellas.
- Repele la suciedad.
- Elimina la cal.
- Efecto anti-estático.
- 750 ml.



Caja de 12 unidades. Tres Cleaner. Limpiador de grifería para baño y cocina

134100106CB12

173,00

- Abrillanta las superficies.
- Elimina las huellas.
- Repele la suciedad.
- Elimina la cal.
- Efecto anti-estático.
- 750 ml.



Conjunto completo para el mantenimiento y limpieza de rociadores y grifería

134100108

32,00

Tres Cleaner 750 ml. + Mango telescópico para limpieza.



Caja de 16 unidades. Conjunto completo para el mantenimiento y limpieza de rociadores y grifería

13410010816

486,00

Tres Cleaner 750 ml. + Mango telescópico para limpieza.



ANEXO

516 Instalación recomendada

518 Recambios

522 Listado de referencias

534 Condiciones de venta



INSTALACIÓN RECOMENDADA

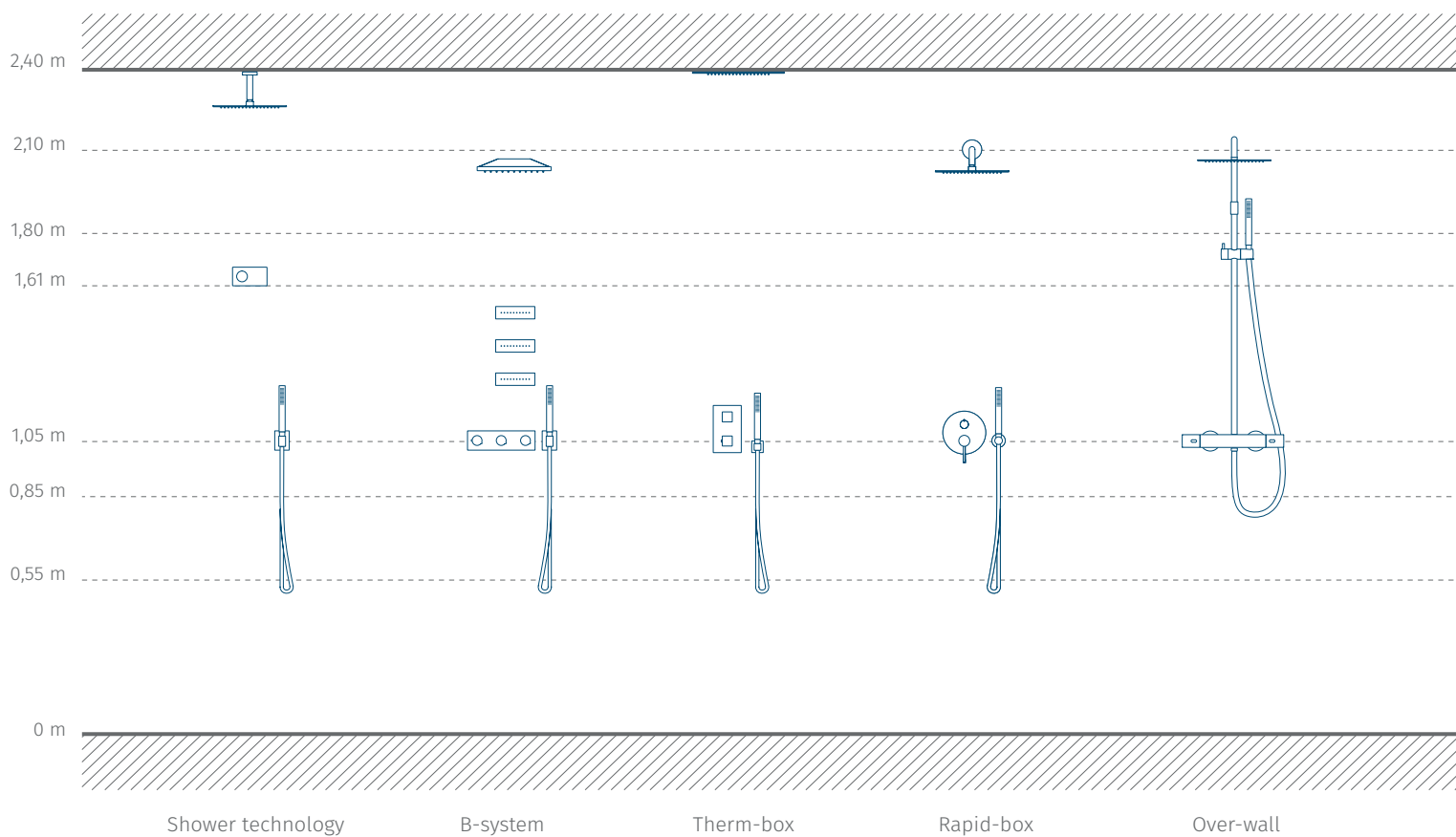



Desagües de ducha o bañera







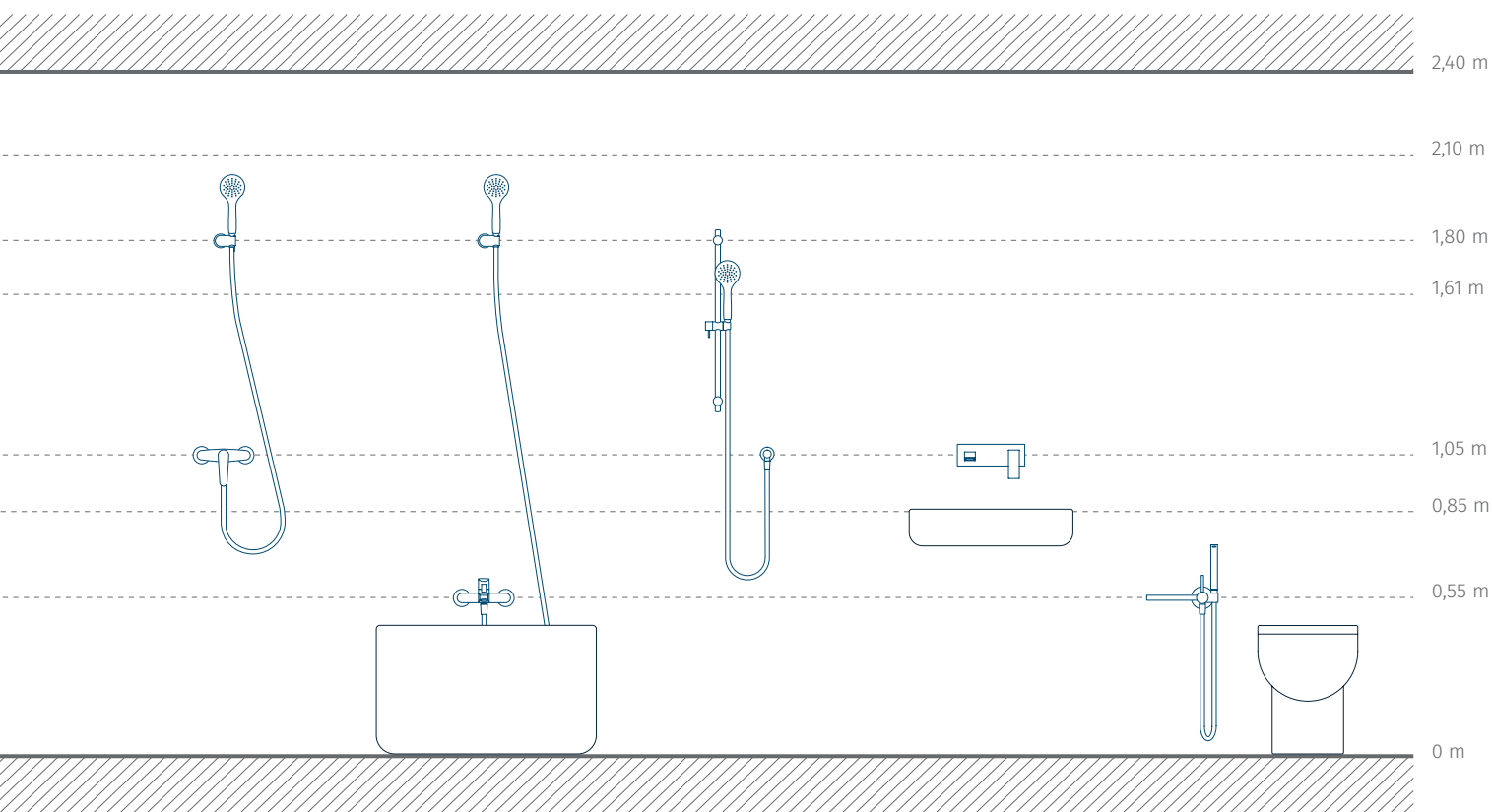

























Se podrán utilizar grifos con 2 salidas de agua al mismo tiempo siempre que el desagüe esté calculado para ello.















Suministro de agua

El caudal de cada producto puede necesitar distintas presiones, pero con una presión dinámica de entre 2 y 3 bar sería suficiente. La presión dinámica se mide con el grifo abierto.





































RECAMBIOS

















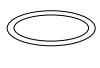
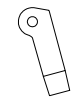
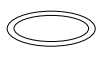



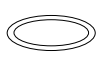

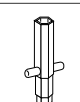

<p>Visite nuestra página web para encontrar más recambios y planos de despiece de la grifería</p>			
	Aireador Cascade SLC. 24 Macho	■ 9134673 ■ 9134673503 ■ 9134673501	6,00 13,00 13,00
	Aireador 18 Macho	9262503	7,00
	Aireador Cascade SLC 22 Hembra	■ 9134672 ■ 9134672501	6,00 13,00
	Aireador 24 Macho; retención "C"	■ 29966310	5,00
	Aireador 28 Macho	9134674	6,00
	Aireador oculto rectangular + llave	9106006	9,00
	Aireador enrasado 24 Macho	29961001	5,00
	Aireador enrasado 16 Macho. Caudal: 8 l/min.	29961002	6,00
	Aireador 16 Macho. Caudal: 5 l/min.	29961005	6,00
	Aireador oculto 16,5 Macho + llave	9134665	7,00
	Aireador oculto 16,5 Macho + llave	9134666	7,00
	Rompeaguas enrasado. 24 Macho + llave	9134668	6,00
	Rompeaguas enrasado y orientable. 24 Macho. + llave	29961006	7,00
	Rótula bidé completa 16,5 + llave	■ 9107672	14,00
	Rótula 22 + Aireador	■ 9134577	7,00
	Rótula 24 + Aireador	■ 9134677	7,00
	Limitador de caudal. 24 Macho. Caudal: 6 l/min.	■ 91346826	6,00
	Limitador de caudal. 24 Macho. Caudal: 8 l/min.	■ 9134682	9,00
	Limitador de caudal. 24 Macho. Caudal: 5 l/min.	■ 91346825	8,00
	Aireador + Casquillo. 24 Macho. Caudal: 5 l/min.	■ 23461305	8,00
	Limitador de caudal. 22 Hembra. Caudal: 6 l/min.	■ 91346816	6,00
	Limitador de caudal. 22 Hembra. Caudal: 8 l/min.	■ 9134681	8,00
	Limitador de caudal. 22 Hembra. Caudal: 5 l/min.	■ 91346815	8,00
	Aireador. 22 Hembra + Casquillo. Caudal: 4,5 l/min.	■ 23466205	6,00
	Aireador enrasado. 24 Macho. Caudal: 4,5 l/min.	23461015	6,00
	Aireador enrasado. 24 Macho. Caudal: 3,8 l/min.	23461013	6,00
	Rompeaguas enrasado. 24 Macho + Casquillo. Caudal: 1,9 l/min.	23466001	6,00
	Aireador enrasado. 16,5 Macho. Caudal: 4,5 l/min.	23461050	6,00
	Aireador enrasado. 24 Macho. Caudal: 4,5 l/min.	23444005	7,00
	Aireador enrasado. 24 Macho. Caudal: 3,8 l/min.	23461303	6,00
	Aireador enrasado. 24 Macho. Caudal: 1,9 l/min.	23461301	6,00
	Aireador. 22 Hembra + Casquillo. Caudal: 3,8 l/min.	■ 23466203	6,00
	Aireador enrasado. 16,5 Macho. Caudal: 4,5 l/min.	23461501	6,00

	Aireador enrasado. 16,5 Macho. Caudal: 3,8 l/min.	23461380	6,00		Ducha extraíble para grifo de cocina. 2 tipos de chorro. R1/2"	9134849	31,00
	Aireador sin casquillo. 17. Caudal: 4,5 l/min.	23466905	6,00		Ducha extraíble para grifo de cocina. 2 tipos de chorro. R1/2"	913043810	36,00
	Aireador sin casquillo. 17. Caudal: 3,8 l/min.	23466938	6,00		Ducha para grifo de cocina R1/2"	9134481	70,00
	Aireador sin casquillo. 21. Caudal: 4,5 l/min.	23467205	6,00		Ducha para grifo de cocina. 2 tipos de chorro. R1/2"	913049310	35,00
	Aireador sin casquillo. 21. Caudal: 3,8 l/min.	23467238	6,00		Pistón	9133317	7,00
	Aireador enrasado. 18,5 Macho. Caudal: 3,8 l/min.	23461038	6,00		Cartucho Mono-term salida libre Ø 40 mm.	29919505	60,00
	Limitador de caudal para flexo 1/2" Macho-hembra. Caudal: 8 l/min.	9134683	11,00		Cartucho salida libre Ø 25 mm. + Limitador 5,5 l/min.	29919001	43,00
	Limitador de caudal para flexo 1/2" Macho-hembra. Caudal: 7,5 l/min.	23468301	9,00		Cartucho salida libre Ø 25 mm.	9130190	40,00
	Limitador de caudal para flexo 1/2" Macho-hembra. Caudal: 6 l/min.	23468303	9,00		Cartucho salida fija Ø 25 mm.	910719005	40,00
	Caño fijo para borde bañera sin distribuidor	913214591	120,00		Cartucho salida fija Ø 35 mm.	9134591	40,00
	Caño para grifería de cocina Ø 28 mm.	9174441	30,00		Cartucho salida libre Ø 35 mm.	9134592	40,00
	Caño tubo 15 cm. R3/4"	9134314	20,00		Cartucho salida fija Ø 40 mm.	9134288	40,00
	Caño tubo 20 cm. R3/4"	9134315	25,00		Cartucho salida libre Ø 40 mm.	9134290	40,00
	Caño tubo 25 cm. R3/4"	9134316	30,00		Cartucho distribuidor 2 vías empotrado. Salida fija Ø 35 mm.	9134235	46,00
	Caño tubo 30 cm. R3/4"	9134319	35,00		Cartucho distribuidor 2 vías termostáticas. Salida libre Ø 35 mm.	9194283	46,00
	Caño tubo para grifo de cocina R3/4"	9134441	30,00		Cartucho termostático con regulador de caudal - Compact	9194552	120,00
	Ducha extraíble para grifo de cocina. 2 tipos de chorro. R1/2"	9134880	28,00		Cartucho termostático Instant 57	29916901	59,00

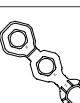

RECAMBIOS

	Cartucho termostático Instant 77	29916902	66,00		Montura cerámica derecha (Cold) Retro-tres	913427220	15,00
	Inversor 2 vías monomando 180	916218005	31,00		Montura cerámica izquierda (Hot) Retro-tres	913427210	15,00
	Inversor 2 vías monomando 180	29955304	31,00		Tubo flexible Macho 8x1 - R3/8" Long. 600 mm.	29908405	11,00
	Inversor 2 vías monomando 180	910618020	31,00		Tubo flexible Macho 8x1 - R3/8" Long. 450 mm.	29908406	10,00
	Inversor 2 vías Mono-term	29955303	31,00		Tubo flexible Macho 9x1 Long. 370 mm.	9134803	9,00
	Inversor automático bañera mural	9134256	14,00		Tubo flexible Macho 10x1 - R3/8" Long. 370 mm.	9134806	8,00
	Inversor automático bañera mural	9134250	13,00		Conjunto varilla y pulsador	913484007	9,00
	Inversor automático bañera mural - Essential	29955306	13,00		Desagüe automático + Varilla	913484057	25,00
	Montura R1/2" Llave de paso ESE-23	9134286	8,00		Desagüe automático + Varilla	913427510	25,00
	Montura R1/2" Llave de paso	9134296	17,00		Tapón para válvula de desagüe automático. Tapón: Ø 63 mm.	913484026	16,00
	Montura R1/2" Standard	9134284	8,00		Tapón para válvula de desagüe automático	913484016	11,00
	Montura R1/2"	9134294	12,00		Unión de las varillas para válvula de desagüe automático	913484005	4,00
	Montura cerámica R1/2"	9134282	15,00		Varilla larga horizontal para válvula de desagüe automático	9134840061	9,00
	Montura cerámica R1/2" Eje corto	9134292	15,00		Base soporte para grifo de cocina	963033331	4,00
	Montura cerámica R1/2" Eje largo	9134293	15,00		Conjunto bloqueo 6x1 Macho Long. 120 mm.	919260634	11,00
	Montura R3/8"	9134283	7,00		Conjunto bloqueo 8x1 Macho Long. 110 mm.	966110301	9,00
	Montura cerámica 16 Macho	9162292	15,00		Conjunto bloqueo 8x1 Macho Long. 250 mm.	916184010	20,00

	Conjunto bloqueo 8x1 Macho Long. 70 mm.	913010334	7,00		Llave multiusos + suplemento cartucho Mono-term	29989601	19,00
	Tornillo fijación caño fundido y caño de tubo. 6x1 Macho	9133317031	4,00		Casquillo caño tubo	29919607	3,00
	Tornillo fijación caño fundido y caño de tubo. 6x1 Macho. Pack 10 unidades	913331703	10,00		Filtro termostática	919416401	3,00
	Tornillo fijación palanca monomando. 5 Macho. Pack 10 unidades	913400831	8,00		Junta tórica NBR 17,17x1,78 mm.	9534294501	2,00
	Tornillo fijación palanca monomando. 5 Macho	9134008311	3,00		Junta tórica NBR 70SH 18x2,2 mm.	9533315501	2,00
	Tapón soporte de cadena	932010331	3,00		Junta tórica NBR 70SH 18x2,2 mm. Pack 10 unidades	953331550	8,00
	Bote de grasa	9134882	7,00		Junta tórica NBR 70SH 41x2,5 mm.	9530440521	2,00
	Llave aireador oculto 16,5 Macho	9134895	3,00		Juntas tóricas NBR 70SH 41x2,5 mm. Pack 10 unidades	953044052	7,00
	Llave aireador oculto 18,5 Macho	9134896	3,00		Junta tórica EPDM 70SH 18,72x2,62 mm.	9533317501	2,00
	Llave aireador oculto 24 Macho	9134897	3,00		Juntas tóricas EPDM 70SH 18,72x2,62 mm. Pack 10 unidades	953331750	7,00
	Llave aireador oculto rectangular	9134898	3,00		Alargadera para grifería de pared	9134872	35,00
	Llave aireadores	9134891	6,00		Set de prolongación para los grifos monomando empotrados para lavabo	21830010	45,00
	Regulador del sensor para grifería electrónica	299392134	10,00		Set de prolongación para los grifos monomando empotrados de 2 vías Rapid-box	29928010	50,00
	Llave bloqueo tuerca	9134893	3,00		Set de prolongación para los grifos monomando empotrados de 2 vías Base/Base Plus	29928011	84,00
	Llave distribuidor monomando empotrado	29989603	21,00		Set de prolongación para los grifos termostáticos empotrados de 2 vías Therm-box	29985001	36,00
	Llave multiusos	9134890	11,00		Set de prolongación para los grifos termostáticos empotrados de 1-2 vías B-System	29985002	40,00
	Llave multiusos + suplemento cartucho Loft	29989602	17,00		Set de prolongación para los grifos termostáticos empotrados de 3-4 vías B-System	29985003	50,00



LISTADO DE REFERENCIAS

Referencia	€		Referencia	€		Referencia	€		Referencia	€		Referencia	€	
00			00625004AC	922,00	287	006486BM	651,00	436	01210003	86,00	471	03453430KM	107,00	489
00610101	163,00	97	00625004BM	922,00	287	006486NM	651,00	436	01210302	93,00	471	03453430KMB	107,00	489
00610101AC	252,00	97	00625004NM	922,00	287	006486OM	924,00	436	01210303	97,00	470	03453430LM	100,00	489
00610101BL	252,00	97	00625004OM	1.256,00	287	00648701	485,00	450	01217901	630,00	475	03453430LV	100,00	489
00610101BM	252,00	97	00625004OR	1.256,00	287	00648701AC	752,00	450	01220002	74,00	472	03453430NM	107,00	489
00610101D	186,00	97	00625005	1.180,00	290	00648701BM	752,00	450	01220703	130,00	426	03453430OM	152,00	489
00610101NE	252,00	97	00625005AC	1.761,00	290	00648701NM	752,00	450	01220704	185,00	426	03453430OP	152,00	489
00610101NM	252,00	97	00625005BM	1.761,00	290	00660502AC	394,00	100	01220801	80,00	473	03453430OPM	152,00	489
00610101OM	358,00	97	00625005NM	1.761,00	290	00660502BM	394,00	100	01240801	68,00	425	03453430OR	152,00	489
00610101OR	358,00	97	00625005OM	2.447,00	290	00660502NM	394,00	100	01240850	152,00	425	03453440AC	146,00	489
00610102	163,00	97	00625005OR	2.447,00	290	00660502OM	559,00	100	01299601	273,00	469	03453440NM	146,00	489
00610102D	186,00	97	00625006	542,00	292	00660502OR	559,00	100				03453440OM	208,00	489
00611001	278,00	98	00625006AC	769,00	292	00660602AC	426,00	100	02			03453440OR	208,00	489
00611001BL	431,00	98	00625006BM	769,00	292	00660602BM	426,00	100	02351501	46,00	254	03463430AC	74,00	492
00611001D	301,00	98	00625006NM	769,00	292	00660602NM	426,00	100	02352001C	43,00	253	03463430BM	74,00	492
00611001NE	431,00	98	00625006OM	1.039,00	292	00660602OM	605,00	100	02352001F	43,00	253	03463430KM	74,00	492
00611002	278,00	98	00625006OR	1.039,00	292	00660602OR	605,00	100	02418201	50,00	396	03463430KMB	74,00	492
00611002BL	431,00	98	00628003	559,00	329	00660702AC	443,00	100	02463609AC	121,00	412	03463430LM	74,00	492
00611002D	301,00	98	00628003AC	818,00	329	00660702BM	443,00	100	02463609LM	113,00	412	03463430LV	74,00	492
00611002NE	431,00	98	00628003BM	818,00	329	00660702NM	443,00	100	02463609OR	172,00	412	03463430NM	74,00	492
00612001	166,00	102	00628003NM	818,00	329	00660702OM	628,00	100				03463430OM	198,00	492
00612001AC	257,00	102	00628003OM	1.125,00	329	00660702OR	628,00	100	03			03463430OP	198,00	492
00612001BL	257,00	102	00628003OR	1.125,00	329	00661001	313,00	97	030335AC	395,00	450	03463430OPM	198,00	492
00612001BM	257,00	102	00628004	582,00	327	00661001AC	485,00	97	030335BM	395,00	450	03463430OR	198,00	492
00612001D	189,00	102	00628004AC	853,00	327	00661001BL	485,00	97	030335NM	395,00	450	03463501	114,00	389
00612001NE	257,00	102	00628004BM	853,00	327	00661001BM	485,00	97	030335OM	561,00	450	03463501AC	177,00	389
00612001NM	257,00	102	00628004NM	853,00	327	00661001NE	485,00	97	030336AC	372,00	437	03463501BM	177,00	389
00612001OM	365,00	102	00628004OM	1.174,00	327	00661001NM	485,00	97	030336BM	372,00	437	03463501KMB	177,00	389
00612001OR	365,00	102	00628004OR	1.174,00	327	00661001OM	688,00	97	03043401	183,00	454	03463501NM	177,00	389
00612301	200,00	103	00628005	1.097,00	331	00661001OR	688,00	97	03044401	204,00	454	03463501OM	251,00	389
00612301AC	310,00	103	00628005AC	1.654,00	331	00661002	313,00	97	03048501	300,00	451	03463501OPM	251,00	389
00612301BM	310,00	103	00628005BM	1.654,00	331	00663901	46,00	371	03049301	294,00	451	03463502	104,00	389
00612301NM	310,00	103	00628005NM	1.654,00	331	00663901AC	71,00	371	030496BM	471,00	436	03463502AC	161,00	389
00612301OM	440,00	103	00628005OM	2.312,00	331	00663901BM	71,00	371	030496NM	471,00	436	03463502BM	161,00	389
00612301OR	440,00	103	00628005OR	2.312,00	331	00663901KM	71,00	371	030496OM	669,00	436	03463502KMB	161,00	389
00612302	240,00	103	00628006	459,00	333	00663901KMB	71,00	371	03411601	41,00	371	03463502NM	161,00	389
00612302AC	372,00	103	00628006AC	662,00	333	00663901NM	71,00	371	03411601AC	64,00	371	03463502OM	229,00	389
00612302BM	372,00	103	00628006BM	662,00	333	00663901OM	101,00	371	03411601BM	64,00	371	03463502OPM	229,00	389
00612302NM	372,00	103	00628006NM	662,00	333	00663901OP	101,00	371	03411601KM	64,00	371	03463505	154,00	388
00612402AC	361,00	103	00628006NM	662,00	333	00663901OPM	101,00	371	03411601KMB	64,00	371	03463505AC	239,00	388
00612402BM	361,00	103	00628006OM	903,00	333	00663901OPM	101,00	371	03411601NM	64,00	371	03463505BM	239,00	388
00612402NM	361,00	103	00628006OR	903,00	333	00681001	383,00	97	03411601NM	64,00	371	03463505KMB	239,00	388
00612402OR	513,00	103	00630021	157,00	101	00681001AC	594,00	97	03411601OM	90,00	371	03463505KMB	239,00	388
00616103	410,00	110	00630021AC	243,00	101	00681001BL	594,00	97	03411601OPM	90,00	371	03463505NM	239,00	388
00616103AC	636,00	110	00630021BM	243,00	101	00681001BL	594,00	97	03411601OR	90,00	371	03463505OPM	339,00	388
00616103BM	636,00	110	00630021NM	243,00	101	00681001BM	594,00	97	03412102	142,00	358	03463506AC	223,00	388
00616103NM	636,00	110	00630021OM	345,00	101	00681001NE	594,00	97	03412401	37,00	85	03463506BM	223,00	388
00616103OM	902,00	110	00630021OR	345,00	101	00681001NM	594,00	97	03412401AC	57,00	85	03463506KMB	223,00	388
00616103OR	902,00	110	00630022	167,00	102	00681001OM	843,00	97	03412401BM	57,00	85	03463506NM	223,00	388
00616104	473,00	110	00630022AC	259,00	102	00681001OR	843,00	97	03412401KM	57,00	85	03463506OPM	317,00	388
00616105	462,00	109	00630022BM	259,00	102	00681002	383,00	98	03412401KMB	57,00	85	03463701	86,00	381
00616105AC	716,00	109	00630022NM	259,00	102	00698003	582,00	108	03412401OM	81,00	85	03463701AC	133,00	381
00616105BM	716,00	109	00630022OM	367,00	102	00712001	166,00	102	03412401OPM	81,00	85	03463701BM	133,00	381
00616105NM	716,00	109	00630022OR	367,00	102	00712001AC	257,00	102	03412401OPM	81,00	85	03463701KMB	133,00	381
00616105OM	1.016,00	109	00630023	210,00	102	00712001BL	257,00	102	03412401OR	81,00	85	03463701NM	133,00	381
00616105OR	1.016,00	109	00630023AC	326,00	102	00712001BM	257,00	102	03412402AC	73,00	103	03463701OM	189,00	381
00618080	550,00	109	00630023BM	326,00	102	00712001D	189,00	102	03412402BM	73,00	103	03463701OPM	189,00	381
00620101	170,00	98	00630023NM	326,00	102	00712001E	189,00	102	03412402NM	73,00	103	03463702	64,00	382
00620101AC	264,00	98	00630023OM	462,00	102	00712001NE	594,00	97	03412402OM	104,00	103	03463706	33,00	383
00620101BM	264,00	98	00630023OR	462,00	102	00712001NM	594,00	97	03412402OR	104,00	103	03463708	95,00	382
00620101NM	264,00	98	00630031	190,00	101	00712001OM	365,00	102	03416101	80,00	479	03463709	67,00	386
00620101OM	374,00	98	00630031AC	295,00	101	00715501	89,00	495	03423101	159,00	361	03463709NM	104,00	386
00620101OR	374,00	98	00630031BM	295,00	101	00715501AC	137,00	495	03433603	118,00	384	03463820AC	78,00	492
00620501AC	407,00	99	00630031NM	295,00	101	00715501BM	137,00	495	03433604	155,00	385	03463820BM	78,00	492
00620501BM	407,00	99	00630031OM	418,00	101	00715501NM	137,00	495	03443301	350,00	360	03463820KM	78,00	492
00620501NM	407,00	99	00630031OR	418,00	101	00715501OM	196,00	495	03443302	270,00	357	03463820KMB	78,00	492
00620501OR	407,00	99	00630032	200,00	10									

Referencia	€		Referencia	€		Referencia	€		Referencia	€		Referencia	€	
03464501BM	225,00	389	06115501OP	182,00	496	06243201AC	132,00	368	09286556	1.294,00	265	10710342AC	310,00	491
03464501KMB	225,00	389	06115501OPM	182,00	496	06243201BM	132,00	368	09286557	1.766,00	264	10710342BM	310,00	491
03464501NM	225,00	389	06115501OR	182,00	496	06243201KMB	132,00	368	09286558	1.195,00	262	10710342KMB	310,00	491
03464501OM	319,00	389	06116701	215,00	161	06243201KMM	132,00	368	09286558OM	1.766,00	262	10710342KMM	310,00	491
03464501OPM	319,00	389	06117001	236,00	161	06243201NM	132,00	368	09286558OPM	1.766,00	262	10710342NM	310,00	491
03464502	160,00	389	06117202	108,00	500	06243201OM	187,00	368	09286561	1.766,00	264	10710342OM	440,00	491
03474007	25,00	490	06118301	35,00	397	06243201OP	187,00	368	09286562	2.064,00	263	10710342OP	440,00	491
03474501	40,00	491	06120301	125,00	157	06243201OPM	187,00	368	09286563	1.242,00	262	10710342OPM	440,00	491
03474501AC	62,00	491	06120301D	148,00	157	06243201OR	187,00	368	09286563OM	1.831,00	262	10710342OR	440,00	491
03474501LM	58,00	491	06120304	217,00	158	062435AC	411,00	437	09286563OPM	1.831,00	262	107103DA	183,00	99
03474501OM	104,00	491	06120601	217,00	157	062435BM	411,00	437	09286564	1.190,00	263	107131	373,00	392
03474501OR	104,00	491	06122001	130,00	160	062435NM	411,00	437	09286564OM	1.757,00	263	10716102	880,00	111
03474601	32,00	488	06122001D	153,00	160	062435OM	583,00	437	09286564OPM	1.757,00	263	107167	313,00	104
03474601AC	50,00	488	06144701	278,00	422	06243601AC	357,00	437	09286567	1.181,00	263	10717002	334,00	104
03474601LM	46,00	488	06144801	310,00	423	06243601BM	357,00	437	09286567OM	1.692,00	263	107181	200,00	499
03474601OM	70,00	488	06151101	91,00	496	06243601NM	357,00	437	09286567OPM	1.692,00	263	10723601	65,00	410
03474601OR	70,00	488	06151101AC	140,00	496	06243601OM	506,00	437	09288308NM	1.978,00	265	10723601AC	101,00	410
03483102	318,00	358	06151101BM	140,00	496	06250301	46,00	478	09288315NM	2.649,00	267	10723601BM	101,00	410
03493101	197,00	387	06151101KMB	140,00	496	06254201	224,00	439	09288404NM	3.756,00	268	10723601KMB	101,00	410
03493101AC	305,00	387	06151101KMM	140,00	496	06254201AC	347,00	439	09288408NM	2.896,00	267	10723601KMM	101,00	410
03493101BM	305,00	387	06151101NM	140,00	496	06254201BM	347,00	439	09288551NM	1.718,00	262	10723601NM	101,00	410
03493101NM	305,00	387	06151101OM	199,00	496	06254201NM	347,00	439	09288552NM	2.050,00	264	10723601OM	143,00	410
03493199	142,00	384	06151101OP	199,00	496	06254201OM	493,00	439	09288555NM	2.039,00	265	10723601OP	143,00	410
03493199AC	220,00	384	06151101OPM	199,00	496	06260301	48,00	478	09288556NM	1.577,00	265	10723601OPM	143,00	410
03493199BM	220,00	384	06151101OR	199,00	496	06298001	513,00	164	09288557NM	2.300,00	264	10723601OR	143,00	410
03493199KMB	220,00	384	06163505	255,00	393	06298004	442,00	164	09288558NM	1.301,00	262	10723603	68,00	410
03493199NM	220,00	384	06163506	336,00	391	06944001	106,00	441	09288561NM	2.310,00	264	10723603AC	106,00	410
03493199OM	312,00	384	06163509	310,00	393	06944401	204,00	454	09288563NM	1.346,00	262	10723603BM	106,00	410
03493199OPM	312,00	384	06183901AC	45,00	394	06944701	102,00	442	09288564NM	1.296,00	263	10723603KMB	106,00	410
03493201	204,00	387	06183901BM	45,00	394				09288567NM	1.250,00	263	10723603KMM	106,00	410
03493201AC	316,00	387	06183901KMB	45,00	394	07			09598101	183,00	413	10723603NM	106,00	410
03493201BM	316,00	387	06183901KMM	45,00	394	07032003	100,00	459	09598101AC	290,00	413	10723603OM	150,00	410
03493201NM	316,00	387	06183901NM	45,00	394	07044802	108,00	442	09598101BM	290,00	413	10723603OP	150,00	410
03493299	149,00	383	06183901OM	64,00	394	07099501	313,00	469	09598101KMB	290,00	413	10723603OPM	150,00	410
03493299AC	231,00	383	06183901OPM	64,00	394				09598101KMM	290,00	413	10723603OR	150,00	410
03493299BM	231,00	383	06183901OR	64,00	394	08			09598101NM	290,00	413	10723606	32,00	410
03493299KMB	231,00	383	06192801	115,00	385	081192	399,00	176	09598101OM	411,00	413	10723606AC	50,00	410
03493299NM	231,00	383	06193102	134,00	388	08119301	425,00	177	09598101OP	411,00	413	10723606BM	50,00	410
03493299OM	328,00	383	06193103	131,00	387	08119302	433,00	177	09598101OPM	411,00	413	10723606KMB	50,00	410
03493299OPM	328,00	383	06193104	155,00	388	08119701	451,00	178	09598101OR	411,00	413	10723606KMM	50,00	410
			06193105	151,00	387	08119702	475,00	176	09598102AC	257,00	413	10723606NM	50,00	410
06			06210301	109,00	157	08119703	470,00	175	09598102BM	257,00	413	10723606OM	83,00	410
06110301	109,00	157	06210301D	132,00	157	08119704	497,00	177	09598102OP	257,00	413	10723606OP	83,00	410
06110301D	132,00	157	06210302	127,00	158	08120001	242,00	172	09598102OPM	257,00	413	10723606OPM	83,00	410
06110302	127,00	158	06210302D	150,00	158	08120002	252,00	172	09598102OR	365,00	413	10723606OPM	83,00	410
06110302D	150,00	158	06212001	112,00	160	08333301	168,00	443	09598102OM	365,00	413	10723620	28,00	410
06110501	278,00	81	06212001AC	273,00	84				09598102OPM	365,00	413	10723620AC	43,00	410
06110501AC	431,00	81	06212001BM	273,00	84	09			09598102OPM	365,00	413	10723620BM	43,00	410
06110501BM	431,00	81	06212001D	135,00	160	09217101	273,00	422	09598102OPM	365,00	413	10723620KMB	43,00	410
06110501KMB	431,00	81	06212001KMB	273,00	84	09226201	1.176,00	55	09598102OR	365,00	413	10723620KMM	43,00	410
06110501KMM	431,00	81	06212001KMM	273,00	84	09226201AC	1.640,00	55				10723620NM	43,00	410
06110501NM	431,00	81	06212001NM	273,00	84	09226201LM	1.624,00	55	10			10723620OM	62,00	410
06110501OM	612,00	81	06212001OM	388,00	84	09226201LV	1.624,00	55	104841	42,00	490	10723620OP	62,00	410
06110501OP	612,00	81	06212001OP	388,00	84	09226201OR	2.158,00	55	106103	160,00	98	10723620OPM	62,00	410
06110501OPM	612,00	81	06212001OPM	388,00	84	09226202	1.213,00	55	106103DA	183,00	98	10723620OR	62,00	410
06110501OR	612,00	81	06212001OR	388,00	84	09226202AC	1.596,00	55	106124	233,00	103	10733605	77,00	410
06110502	294,00	82	06212001TAM	273,00	84	09226202LM	1.589,00	55	10616102	890,00	111	10733605AC	119,00	410
06110502AC	456,00	82	06212001TAM	273,00	84	09226202LV	1.589,00	55	106177	126,00	108	10733605BM	119,00	410
06110502BM	456,00	82	06212001TRO	273,00	84	09226202OR	2.095,00	55	10617710	95,00	108	10733605KMB	119,00	410
06110502KMB	456,00	82	06216102	360,00	166	09226301	1.383,00	55	106180	210,00	108	10733605KMM	119,00	410
06110502KMM	456,00	82	06217702	116,00	164	09226301AC	1.834,00	55	10618010	105,00	108	10733605NM	119,00	410
06110502NM	456,00	82	06218002	179,00	164	09226301LM	1.805,00	55	10620501	263,00	99	10733605OM	231,00	410
06110502OM	647,00	82	06218080	479,00	165	09226301LV	1.805,00	55	106245	415,00	406	10733605OP	231,00	410
06110502OP	647,00	82	06218081	414,00	165	09226301OR	2.422,00	55	10627810	89,00	322	10733605OPM	231,00	410
06110502OPM	647,00	82	06220301	125,00	157	09226302	1.355,00	56	10627810AC	138,00	322	10733605OR	231,00	410
06110502OR	647,00	82	06220301D	148,00	157	09226302AC	1.791,00	56	10627810BM	138,00	322	107476	378,00	390
06112001	112,00	160	06220304	217,00	158	09226302LM	1.770,00	56	10627810NM	138,00	322	107503	158,00	100
06112001AC	174,00	84	06220601	217,00	158	09226302LV	1.770,00	56	10627810OM	196,00	322	107511	96,00	496
06112001BM	273,00	84	06222001	130,00	160	09226302OR	2.340,00	56	10627810OR	196,00	322	107839	31,00	394
06112001D	135,00	160	06222001D	153,00	160	09244501AC	345,00	455	10628110	116,00	324	107839BM	48,00	394
06112001KMB	273,00	84	06225001	116,00	284	09244601	310,00	455	10628110AC	179,00	324	107839NM	48,00	394
06112001KMM	273,00	84	06225003	480,00	290	092826302	3.005,00	266	10628110BM	179,00	324	107839OM	68,00	394
06112001NM	273,00	84	06225004	515,00	288	092826304	2.249,00	266	10628110NM	179,00	324	107839OR	68,00	394
06112001OM	388,00	84	06225005	1.131,00	292									

LISTADO DE REFERENCIAS

Referencia	€	📄	Referencia	€	📄	Referencia	€	📄	Referencia	€	📄	Referencia	€	📄
112178	94,00	474	134100108	32,00	513	134315007OR	451,00	362	13462101	65,00	366	134944	820,00	356
112200	89,00	472	13410010816	486,00	513	134315008	260,00	361	13462102	60,00	368	134944AC	1.271,00	356
112205	104,00	473	134122	230,00	85	134315008AC	403,00	361	13462102AC	93,00	368	134944BM	1.271,00	356
112370	230,00	464	134122AC	357,00	85	134315008BM	403,00	361	13462102BM	93,00	368	134944NM	1.271,00	356
112441	40,00	463	134122BM	357,00	85	134315008NM	403,00	361	13462102KMB	93,00	368	134944OM	1.804,00	356
114444	315,00	453	134122NM	357,00	85	134315008OM	572,00	361	13462102NM	93,00	368	134944OR	1.804,00	356
117333	93,00	444	134123	190,00	84	134315008OR	572,00	361	13462102OM	132,00	368	134950	1.030,00	356
117440	112,00	441	134123AC	295,00	84	134315009	98,00	365	13462102OP	132,00	368	13495001	775,00	357
12			134123BM	295,00	84	134315010	145,00	364	13462102OPM	132,00	368	13495001AC	1.201,00	357
123100C	36,00	252	134123KM	295,00	84	134315010AC	225,00	364	13462102OR	132,00	368	13495001BM	1.201,00	357
123100F	36,00	252	134123KMB	295,00	84	134315010BM	225,00	364	13462104	77,00	366	13495001KM	1.201,00	357
123103	108,00	252	134123NM	295,00	84	134315010KM	225,00	364	13462104AC	119,00	366	13495001KMB	1.201,00	357
123120	111,00	252	134123OM	418,00	84	134315010KMB	225,00	364	13462104BM	119,00	366	13495001NM	1.201,00	357
123125C	40,00	252	134123OP	418,00	84	134315010NM	225,00	364	13462104KM	119,00	366	13495001OM	1.705,00	357
123125F	40,00	252	134123OPM	418,00	84	134315010OM	319,00	364	13462104KMB	119,00	366	13495001OP	1.705,00	357
123155C	33,00	254	134123OR	418,00	84	134315010OPM	319,00	364	13462104NM	119,00	366	13495001OPM	1.705,00	357
123155F	33,00	254	13413726	82,00	365	134315010OPM	319,00	364	13462104OM	169,00	366	13495001OR	1.705,00	357
123167	118,00	253	13413730	256,00	364	134315010OR	319,00	364	13462104OP	169,00	366	13495002	861,00	356
123170	160,00	253	13413730AC	397,00	364	134315011	145,00	362	13462104OPM	169,00	366	13495002AC	1.335,00	356
123210	75,00	457	13413730BM	397,00	364	134315012	172,00	362	13462104OR	169,00	366	13495002BM	1.335,00	356
123214	76,00	457	13413730KMB	397,00	364	134315012AC	267,00	362	13462202	77,00	368	13495002KM	1.335,00	356
123215	78,00	457	13413730KMB	397,00	364	134315012BM	267,00	362	13462202AC	119,00	368	13495002KMB	1.335,00	356
123217	97,00	459	13413730NM	397,00	364	134315012KM	267,00	362	13462202BM	119,00	368	13495002NM	1.335,00	356
123230	80,00	457	13413730OM	563,00	364	134315012KMB	267,00	362	13462202NM	119,00	368	13495002OM	1.894,00	356
123306	52,00	464	13413730OP	563,00	364	134315012NM	267,00	362	13462202OM	169,00	368	13495002OP	1.894,00	356
123310	78,00	456	13413730OPM	563,00	364	134315012OM	378,00	362	13462202OR	169,00	368	13495002OPM	1.894,00	356
123314	78,00	458	13413730OR	563,00	364	134315012OP	378,00	362	134627	17,00	374	13495002OR	1.894,00	356
123315	80,00	458	13413826	82,00	363	134315012OPM	378,00	362	134628	122,00	386	134950AC	1.597,00	356
123317	99,00	459	13413830	268,00	362	134315012OR	378,00	362	134629	137,00	386	134950BM	1.597,00	356
123330	82,00	458	13413830AC	415,00	362	13431501A	220,00	362	13463301	79,00	367	134950NM	1.597,00	356
123342	85,00	456	13413830BM	415,00	362	134315015	172,00	364	13463302	79,00	367	134950OM	2.266,00	356
123360	86,00	458	13413830KMB	415,00	362	13431513	46,00	366	13463303	77,00	367	134950OR	2.266,00	356
123416	96,00	458	13413830KMB	415,00	362	134331	185,00	358	13463304	44,00	369	134951	1.030,00	355
123500C	25,00	253	13413830NM	415,00	362	13434010	30,00	483	13463310	14,00	488	13495101	825,00	355
123500F	25,00	253	13413830OM	590,00	362	13434020	30,00	487	13463340	43,00	493	13495101AC	1.279,00	355
123505	40,00	464	13413830OP	590,00	362	13434120	30,00	486	13463340NM	67,00	493	13495101BM	1.279,00	355
123510C	59,00	252	13413830OPM	590,00	362	134432	220,00	361	134633420	63,00	493	13495101KMB	1.279,00	355
123510F	59,00	252	13413940	90,00	366	134433	340,00	360	13463342NM	98,00	493	13495101KMB	1.279,00	355
123511C	31,00	254	13413940AC	140,00	366	134445	100,00	490	134633430	32,00	492	13495101NM	1.279,00	355
123511F	31,00	254	13413940BM	140,00	366	134512	105,00	385	134633440	23,00	493	13495101OM	1.815,00	355
123512C	30,00	254	13413940BMB	140,00	366	13451501	473,00	399	134633450	23,00	488	13495101OP	1.815,00	355
123512F	30,00	254	13413940NM	140,00	366	13451501AC	732,00	399	134633460	5,00	494	13495101OPM	1.815,00	355
123513C	29,00	255	13413940NM	198,00	366	13451501BM	732,00	399	13463810	22,00	493	13495101OR	1.815,00	355
123513F	29,00	255	13413940OPM	198,00	366	13451501KM	732,00	399	13463820	34,00	492	13495102	895,00	355
123515	43,00	254	13416703	80,00	475	13451501KMB	732,00	399	13463910	13,00	487	13495102AC	1.387,00	355
123520C	36,00	253	13416803	103,00	475	13451501NM	732,00	399	134714	530,00	356	13495102BM	1.387,00	355
12423601	78,00	412	134184	39,00	411	13451501OM	1.040,00	399	134715	530,00	357	13495102KMB	1.387,00	355
12423601AC	121,00	412	134184AC	60,00	411	13451501OP	1.040,00	399	134738	56,00	370	13495102NM	1.387,00	355
12423601LM	113,00	412	134184ABM	60,00	411	13451501OPM	1.040,00	399	13473850	20,00	370	13495102NM	1.387,00	355
12423601LV	113,00	412	134184ABM	60,00	411	13451501OR	1.040,00	399	13474010	20,00	491	13495102OM	1.969,00	355
12423601OR	172,00	412	134184AKM	60,00	411	134516	68,00	380	13474010AC	31,00	491	13495102OP	1.969,00	355
12423603	82,00	412	134184KMB	60,00	411	134517	100,00	380	13474010BM	31,00	491	13495102OPM	1.969,00	355
12423603AC	127,00	412	134184NM	60,00	411	134520	100,00	380	13474010KMB	31,00	491	13495102OR	1.969,00	355
12423603LM	119,00	412	134184OM	100,00	411	13452102	50,00	369	13474010KMB	31,00	491	134951AC	1.597,00	355
12423603OR	119,00	412	134184OP	100,00	411	13452102AC	78,00	369	13474010NM	31,00	491	134951BM	1.597,00	355
12423606	52,00	412	134184OPM	100,00	411	13452102BM	78,00	369	13474010OM	44,00	491	134951NM	1.597,00	355
12423606AC	81,00	412	134184OR	100,00	411	13452102KM	78,00	369	13474010OP	44,00	491	134951OM	2.266,00	355
12423606LM	75,00	412	13420503	66,00	473	13452102KMB	78,00	369	13474010OPM	44,00	491	134951OP	2.152,00	355
12423606LV	75,00	412	134215023	7,00	395	13452102NM	78,00	369	13474010OR	44,00	491	134951OPM	2.152,00	355
12423607	22,00	413	134215024	16,00	493	13452102OM	110,00	369	13474020	9,00	491	134951OR	2.266,00	355
12423607AC	34,00	413	134215026	13,00	485	13452102OP	110,00	369	13474110	24,00	413	13499501	1.570,00	468
12423607LM	32,00	413	134215027	14,00	491	13452102OPM	110,00	369	13474110AC	37,00	413	13499502	1.675,00	468
12423607LV	32,00	413	134215028	19,00	485	13452102OR	110,00	369	13474110BM	37,00	413	13499503	1.045,00	469
12423607OR	48,00	413	134221	125,00	358	134522	141,00	385	13474110NM	37,00	413	13499504	1.780,00	468
12463609	80,00	412	134232	151,00	361	13452202	67,00	368	13474110OM	53,00	413	139441	85,00	441
13			134233	163,00	360	13452202AC	104,00	368	13474210	13,00	495	14		
130335	255,00	450	13424010	23,00	484	13452202BM	104,00	368	13474220	16,00	495	143835	25,00	382
130336	240,00	437	13424020	29,00	484	13452202NM	104,00	368	13474310	18,00	487	143836	63,00	386
130481	275,00	463	13424030	24,00	484	13452202OM	147,00	368	13474320	17,00	487	16		
130484	325,00	463	134302	55,00	500	13452202OR	147,00	368	13474330	17,00	487	16110342	170,00	492
130495	455,00	462	134303	59,00	501	13453410	35,00	489	134748	48,00	372	16110342AC	264,00	492
130496	304,00	436	134315001	57,00	365	13453420	32,00	489	134757	23,00	398	16110342BM	264,00	492
13315510C	62,00	255	134315002	77,00	363	13453430	69,00	489	134808	39,00	370	16110342KMB	264,00	492
13315510F	62,00	255	134315003	103,00	365	13453440	95,00	489	134818					

Referencia	€		Referencia	€		Referencia	€		Referencia	€		Referencia	€	
16118740BM	119,00	367	17031802	102,00	461	19016429AC	366,00	310	19017414OM	751,00	313	19031205NM	997,00	308
16118740KMB	119,00	367	17032002	107,00	460	19016429BM	366,00	310	19017414OPM	751,00	313	19031205OM	1.415,00	308
16118740NM	119,00	367	17033202	118,00	461	19016429KMB	366,00	310	19017415	341,00	312	19031205OPM	1.415,00	308
16118740OM	169,00	367	17033302	85,00	444	19016429NM	366,00	310	19017415AC	529,00	312	19031212	654,00	309
16118740OP	169,00	367	17041802	105,00	460	19016429OM	520,00	310	19017415BM	529,00	312	19031212AC	1.014,00	309
16118740OPM	169,00	367	17044002	108,00	442	19016429OPM	520,00	310	19017415KMB	529,00	312	19031212BM	1.014,00	309
16118740OR	169,00	367	17044102	76,00	441	19016439	236,00	311	19017415NM	529,00	312	19031212KMB	1.014,00	309
161194	310,00	497	17044702	102,00	443	19016439AC	366,00	311	19017415OM	751,00	312	19031212NM	1.014,00	309
161194AC	481,00	497	172218	108,00	461	19016439BM	366,00	311	19017415OPM	751,00	312	19031212OM	1.439,00	309
161194NM	481,00	497	172317	108,00	459	19016439KMB	366,00	311	19017419	288,00	200	19031212OPM	1.439,00	309
161194OM	682,00	497	172318	118,00	459	19016439NM	366,00	311	19017419NM	446,00	200	19031215	685,00	308
161194OPM	682,00	497	17231811	200,00	476	19016439OM	520,00	311	19017428	388,00	313	19031215AC	1.062,00	308
161213	342,00	393	172333	82,00	444	19016439OPM	520,00	311	19017428AC	601,00	313	19031215BM	1.062,00	308
161214	315,00	392	17233311	154,00	476	19016449	236,00	311	19017428BM	601,00	313	19031215KMB	1.062,00	308
16123601	60,00	411	172418	98,00	461	19016449AC	366,00	311	19017428KMB	601,00	313	19031215NM	1.062,00	308
16123601AC	93,00	411	172420	118,00	461	19016449BM	366,00	311	19017428NM	601,00	313	19031215OM	1.507,00	308
16123601BM	93,00	411	172440	112,00	442	19016449KMB	366,00	311	19017428OM	854,00	313	19031215OPM	1.507,00	308
16123601KM	93,00	411	172447	102,00	443	19016449NM	366,00	311	19017428OPM	854,00	313	19038501	475,00	201
16123601KMB	93,00	411	172450	130,00	477	19016449OM	520,00	311	19017429	320,00	313	19038701	480,00	201
16123601NM	93,00	411				19016449OPM	520,00	311	19017429AC	496,00	313	19038701NM	744,00	201
16123601OM	132,00	411	18			19016459	236,00	310	19017429BM	496,00	313	19038702	609,00	303
16123601OP	132,00	411	181103	109,00	171	19016459AC	366,00	310	19017429KMB	496,00	313	19038702AC	944,00	303
16123601OPM	132,00	411	181113	194,00	174	19016459BM	366,00	310	19017429NM	496,00	313	19038702BM	944,00	303
16123601OR	132,00	411	181120	112,00	173	19016459KMB	366,00	310	19017429OM	705,00	313	19038702KMB	944,00	303
16123602	63,00	411	181191	412,00	176	19016459NM	366,00	310	19017429OPM	705,00	313	19038702NM	944,00	303
16123602AC	98,00	411	18119102	412,00	175	19016459OM	520,00	310	19017439	320,00	314	19038702OM	1.340,00	303
16123602BM	98,00	411	181203	135,00	171	19016459OPM	520,00	310	19017439AC	496,00	314	19038702OPM	1.340,00	303
16123602KMB	98,00	411	181217	214,00	171	19016469	278,00	310	19017439BM	496,00	314	19038705	580,00	304
16123602KMB	98,00	411	181222	227,00	174	19016469AC	431,00	310	19017439KMB	496,00	314	19038705AC	899,00	304
16123602NM	98,00	411	181223	182,00	174	19016469BM	431,00	310	19017439NM	496,00	314	19038705BM	899,00	304
16123602OM	139,00	411	181341	135,00	440	19016469NM	431,00	310	19017439OM	705,00	314	19038705KMB	899,00	304
16123602OP	139,00	411	181436	210,00	437	19016469OM	612,00	310	19017439OPM	705,00	314	19038705NM	899,00	304
16123602OPM	139,00	411	181437	255,00	453	19017401	243,00	200	19017449	320,00	314	19038705OM	1.276,00	304
16123602OR	139,00	411	181438	260,00	452	19017401NM	377,00	200	19017449AC	496,00	314	19038705OPM	1.276,00	304
16123606	30,00	411	181468	173,00	175	19017402	273,00	313	19017449BM	496,00	314	19038706	583,00	304
16123606AC	47,00	411	181474	194,00	175	19017402AC	423,00	313	19017449KMB	496,00	314	19038707	435,00	307
16123606BM	47,00	411	181540	228,00	439	19017402BM	423,00	313	19017449NM	496,00	314	19038708	489,00	306
16123606KMB	47,00	411	181903	113,00	171	19017402KMB	423,00	313	19017449OM	705,00	314	19038709	539,00	305
16123606NM	47,00	411	181920	117,00	173	19017402NM	423,00	313	19017449OPM	705,00	314	19038710	420,00	248
16123606NM	47,00	411	183341	125,00	440	19017402OM	601,00	313	19017459	320,00	312	19039301	412,00	201
16123606OM	90,00	411	186103	132,00	171	19017402OPM	601,00	313	19017459AC	496,00	312	19039301NM	639,00	201
16123606OP	90,00	411	186120	135,00	173	19017403	273,00	314	19017459BM	496,00	312	19039302	559,00	305
16123606OPM	90,00	411	186203	159,00	171	19017403AC	423,00	314	19017459KMB	496,00	312	19039302AC	866,00	305
16123606OR	90,00	411	186217	237,00	171	19017403BM	423,00	314	19017459NM	496,00	312	19039302BM	866,00	305
16123620	18,00	411	186920	140,00	173	19017403KMB	423,00	314	19017459OM	705,00	312	19039302KMB	866,00	305
16123620AC	28,00	411	18718250	368,00	499	19017403NM	423,00	314	19017459OPM	705,00	312	19039302NM	866,00	305
16123620BM	28,00	411				19017403OM	601,00	314	19017469	373,00	312	19039302OM	1.230,00	305
16123620KMB	28,00	411	19			19017403OPM	601,00	314	19017469AC	550,00	312	19039302OPM	1.230,00	305
16123620NM	28,00	411	19016401	178,00	200	19017404	273,00	314	19017469BM	550,00	312	19039305	625,00	303
16123620OP	40,00	411	19016401NM	276,00	200	19017404AC	423,00	314	19017469NM	550,00	312	19039305AC	969,00	303
16123620OPM	40,00	411	19016402	189,00	310	19017404BM	423,00	314	19017469OM	710,00	312	19039305BM	969,00	303
16123620OR	40,00	411	19016402AC	293,00	310	19017404KMB	423,00	314	19017479	388,00	314	19039305KMB	969,00	303
16133602	72,00	412	19016402BM	293,00	310	19017404NM	423,00	314	19017479AC	601,00	314	19039305NM	969,00	303
16133602AC	112,00	412	19016402KMB	293,00	310	19017404OM	601,00	314	19017479BM	601,00	314	19039305OM	1.375,00	303
16133602BM	112,00	412	19016402NM	293,00	310	19017404OPM	601,00	314	19017479KMB	601,00	314	19039305OPM	1.375,00	303
16133602KM	112,00	412	19016402OM	416,00	310	19017405	273,00	312	19017479NM	601,00	314	19039306	671,00	302
16133602KMB	112,00	412	19016402OPM	416,00	310	19017405AC	423,00	312	19017479OM	854,00	314	19039306AC	1.040,00	302
16133602NM	112,00	412	19016403	189,00	311	19017405BM	423,00	312	19017479OPM	854,00	314	19039306BM	1.040,00	302
16133602OM	216,00	412	19016403AC	293,00	311	19017405KMB	423,00	312	19017489	388,00	312	19039306KMB	1.040,00	302
16133602OP	216,00	412	19016403BM	293,00	311	19017405NM	423,00	312	19017489AC	601,00	312	19039306NM	1.040,00	302
16133602OPM	216,00	412	19016403KMB	293,00	311	19017405OM	601,00	312	19017489BM	601,00	312	19039306OM	1.476,00	302
16133602OR	216,00	412	19016403NM	293,00	311	19017405OPM	601,00	312	19017489KMB	601,00	312	19039307	596,00	304
161445	325,00	455	19016403OM	416,00	311	19017406	326,00	312	19017489NM	601,00	312	19039307AC	924,00	304
161446	375,00	455	19016403OPM	416,00	311	19017406AC	505,00	312	19017489OM	854,00	312	19039307BM	924,00	304
161475	257,00	392	19016404	189,00	311	19017406BM	505,00	312	19017489OPM	854,00	312	19039307KMB	924,00	304
161835	38,00	382	19016404AC	293,00	311	19017406NM	505,00	312	19017499	388,00	313	19039307NM	924,00	304
161838	59,00	383	19016404BM	293,00	311	19017406OM	716,00	312	19017499AC	601,00	313	19039307OPM	1.311,00	304
161839	29,00	394	19016404KMB	293,00	311	19017412	341,00	313	19017499BM	601,00	313	19039307OPM	1.311,00	304
161840	44,00	483	19016404NM	293,00	311	19017412AC	529,00	313	19017499KMB	601,00	313	19039308	620,00	302
162161	790,00	166	19016404OM	416,00	311	19017412BM	529,00	313	19017499NM	601,00	313	19039308AC	961,00	302
16216150	315,00	499	19016404OPM	416,00	311	19017412KMB	529,00	313	19017499OM	854,00	313	19039308BM	961,00	302
162245	415,00	406	19016405	189,00	310	19017412NM	529,00	313	19017499OPM	854,00	313	19039308NM	961,00	302
162435	265,00	437	19016405AC	293,00	310	19017412OM	751,00	313	19019601	259,00	247	1		

LISTADO DE REFERENCIAS

Referencia	€		Referencia	€		Referencia	€		Referencia	€		Referencia	€	
19039316	464,00	225	20017001OM	589,00	122	20020503OM	520,00	120	20210305AC	618,00	63	20227301	1.076,00	334
19039317	429,00	248	20017001OR	589,00	122	20020503OR	520,00	120	20210305BM	618,00	63	20227301AC	1.618,00	334
19039318	443,00	307	20017701	116,00	122	20020504	210,00	119	20210305KMB	618,00	63	20227301BM	1.618,00	334
19063502	362,00	391	20018001	179,00	122	20020504AC	326,00	119	20210305NM	618,00	63	20227301KMB	1.618,00	334
19063502BM	561,00	391	20018001AC	277,00	122	20020504BL	326,00	119	20210305OM	878,00	63	20227301NM	1.618,00	334
19063502KMB	561,00	391	20018001BM	277,00	122	20020504BM	326,00	119	20210305OR	878,00	63	20227301OM	2.258,00	334
19063502NM	561,00	391	20018001NM	277,00	122	20020504NE	326,00	119	20210306	399,00	64	20227301OR	2.258,00	334
19063502OM	797,00	391	20018001OM	393,00	122	20020504NM	326,00	119	20210501	389,00	64	20227302	1.445,00	336
19063502OPM	797,00	391	20018001OR	393,00	122	20020504OM	462,00	119	20210501AC	602,00	64	20227302AC	2.189,00	336
19063504	349,00	390	20018002	479,00	123	20020504OR	462,00	119	20210501BM	602,00	64	20227302BM	2.189,00	336
19063504AC	540,00	390	20018005	725,00	123	20020505	221,00	119	20210501NM	602,00	64	20227302KMB	2.189,00	336
19063504BM	540,00	390	20018005AC	1.124,00	123	20020505AC	342,00	119	20210501OM	855,00	64	20227302NM	2.189,00	336
19063504NM	540,00	390	20018005BM	1.124,00	123	20020505BL	342,00	119	20210501OR	855,00	64	20227302OM	3.069,00	336
19063504OM	767,00	390	20018005NM	1.124,00	123	20020505BM	342,00	119	20212001	196,00	67	20227302OR	3.069,00	336
19260603	305,00	419	20018005OM	1.596,00	123	20020505NE	342,00	119	20212001AC	304,00	67	20227303	786,00	335
19290603	347,00	422	20018005OR	1.596,00	123	20020505NM	342,00	119	20212001BM	304,00	67	20227303AC	1.203,00	335
20			20018009	419,00	124	20020505OM	485,00	119	20212001D	219,00	67	20227303BM	1.203,00	335
20010101	158,00	118	20018010	100,00	122	20020505OR	485,00	119	20212001KMB	304,00	67	20227303NM	1.203,00	335
20010101D	181,00	118	20018010AC	152,00	122	20020506	231,00	119	20212001NM	304,00	67	20227303OM	1.618,00	335
20010102	158,00	117	20018010BM	152,00	122	20020506AC	358,00	119	20212001OM	432,00	67	20227303OR	1.618,00	335
20010102D	181,00	117	20018010NM	152,00	122	20020506BL	358,00	119	20212001OR	432,00	67	20227310	125,00	325
20010301	131,00	117	20018010OM	221,00	122	20020506BM	358,00	119	20212002	196,00	67	20227310AC	194,00	325
20010301AC	203,00	117	20018010OR	221,00	122	20020506NE	358,00	119	20212002D	219,00	67	20227310BM	194,00	325
20010301BL	203,00	117	20018011	453,00	123	20020506NM	358,00	119	20216101	460,00	73	20227310NM	194,00	325
20010301BM	203,00	117	20018080	446,00	124	20020506OM	508,00	119	20216101AC	713,00	73	20227310OM	275,00	325
20010301D	154,00	117	20018201	55,00	396	20020506OR	508,00	119	20216101BM	713,00	73	20227310OR	275,00	325
20010301NE	203,00	117	20018201AC	85,00	396	20022401	202,00	121	20216101NM	713,00	73	20227810	89,00	322
20010301NM	203,00	117	20018201BM	85,00	396	20022401AC	312,00	121	20216101OM	1.012,00	73	20227810AC	138,00	322
20010301OM	289,00	117	20018201NM	85,00	396	20022401BL	312,00	121	20216101OR	1.012,00	73	20227810BM	138,00	322
20010301OR	289,00	117	20018201OM	120,00	396	20022401BM	312,00	121	20216103	450,00	73	20227810KMB	138,00	322
20010302	131,00	117	20018201OR	120,00	396	20022401NE	312,00	121	20216103AC	698,00	73	20227810NM	138,00	322
20010302AC	203,00	117	20018301	35,00	397	20022401NM	312,00	121	20216103BM	698,00	73	20227810OM	196,00	322
20010302BL	203,00	117	20020303	244,00	118	20022401OM	444,00	121	20216103NM	698,00	73	20227810OR	196,00	322
20010302BM	203,00	117	20020303AC	378,00	118	20022401OR	444,00	121	20216103OM	990,00	73	20228003	621,00	329
20010302D	154,00	117	20020303BL	378,00	118	20024501	415,00	406	20216103OR	990,00	73	20228003AC	916,00	329
20010302NE	203,00	117	20020303BM	378,00	118	20024501AC	518,00	406	20216701	344,00	68	20228003BM	916,00	329
20010302NM	203,00	117	20020303NE	378,00	118	20024501BM	643,00	406	20216701AC	534,00	68	20228003NM	916,00	329
20010302OM	289,00	117	20020303OM	536,00	118	20024501KMB	643,00	406	20216701BM	534,00	68	20228003OM	1.263,00	329
20010302OR	289,00	117	20020303OR	536,00	118	20024501NM	643,00	406	20216701KMB	534,00	68	20228003OR	1.263,00	329
20011001	223,00	118	20020304	244,00	117	20024501NM	912,00	406	20216701NM	534,00	68	20228004	595,00	326
20011001BL	345,00	118	20020304AC	378,00	117	20024501OP	912,00	406	20216701OM	758,00	68	20228004AC	868,00	326
20011001NE	345,00	118	20020304BL	378,00	117	20024501OPM	912,00	406	20216701OR	758,00	68	20228004BM	868,00	326
20011002	223,00	118	20020304BM	378,00	117	20024501OPM	912,00	406	20217001	365,00	68	20228004KMB	868,00	326
20011002BL	345,00	118	20020304NE	378,00	117	20024501OR	912,00	406	20217001AC	566,00	68	20228004NM	868,00	326
20011002NE	345,00	118	20020304NM	378,00	117	20030021	150,00	120	20217001BM	566,00	68	20228004OM	1.195,00	326
20012001	134,00	121	20020304OM	536,00	117	20030021AC	233,00	120	20217001KMB	566,00	68	20228004OR	1.195,00	326
20012001AC	208,00	121	20020304OR	536,00	117	20030021BM	233,00	120	20217001NM	566,00	68	20228005	750,00	326
20012001BL	208,00	121	20020305	278,00	118	20030021OM	233,00	120	20217001OM	804,00	68	20228005AC	1.108,00	326
20012001BM	208,00	121	20020305AC	431,00	118	20030021OR	330,00	120	20217001OR	804,00	68	20228005BM	1.108,00	326
20012001D	158,00	121	20020305BL	431,00	118	20030022	160,00	120	20218221	48,00	395	20228005NM	1.108,00	326
20012001NE	208,00	121	20020305BM	431,00	118	20030022AC	248,00	120	20218221AC	74,00	395	20228005OM	1.537,00	326
20012001NM	208,00	121	20020305NE	431,00	118	20030022BM	248,00	120	20218221BM	74,00	395	20228005OR	1.537,00	326
20012001OM	296,00	121	20020305NM	431,00	118	20030022NM	248,00	120	20218221NM	74,00	395	20228006	1.100,00	331
20012001OR	296,00	121	20020305OM	612,00	118	20030022OM	352,00	120	20218221OR	106,00	395	20228006AC	1.657,00	331
20012002	134,00	121	20020305OR	612,00	118	20030022OR	352,00	120	20219101	715,00	68	20228006BM	1.657,00	331
20012002AC	208,00	121	20020306	278,00	117	20044002	232,00	439	20219101AC	1.108,00	68	20228006NM	1.657,00	331
20012002BL	208,00	121	20020306AC	431,00	117	20044002AC	360,00	439	20219101BM	1.108,00	68	20228006OM	2.316,00	331
20012002BM	208,00	121	20020306BL	431,00	117	20044002BM	360,00	439	20219101KMB	1.108,00	68	20228006OR	2.316,00	331
20012002D	158,00	121	20020306BM	431,00	117	20044002NM	360,00	439	20219101NM	1.108,00	68	20228007	462,00	333
20012002NE	208,00	121	20020306NE	431,00	117	20047501	252,00	391	20224501	415,00	406	20228007AC	651,00	333
20012002NM	208,00	121	20020306NM	431,00	117	20050301	100,00	120	20224501AC	643,00	406	20228007BM	651,00	333
20012002OM	296,00	121	20020306OM	612,00	117	20050301AC	155,00	120	20224501BM	643,00	406	20228007NM	651,00	333
20012002OR	296,00	121	20020306OR	612,00	117	20050301BM	155,00	120	20224501NM	643,00	406	20228007OM	907,00	333
20016201	400,00	125	20020501	194,00	119	20050301NM	155,00	120	20224501OR	912,00	406	20228007OR	907,00	333
20016201AC	620,00	125	20020501AC	301,00	119	20050301OM	219,00	120	20224501OR	912,00	406	20228110	116,00	323
20016201BM	620,00	125	20020501BL	301,00	119	20050301OR	219,00	120	20225053	705,00	288	20228110AC	179,00	323
20016201NM	620,00	125	20020501BM	301,00	119	20210301	193,00	63	20225053AC	1.023,00	288	20228110BM	179,00	323
20016201OM	880,00	125	20020501NE	301,00	119	20210301AC	299,00	63	20225053BM	1.023,00	288	20228110KMB	179,00	323
20016201OR	880,00	125	20020501NM	301,00	119	20210301BM	299,00	63	20225053KMB	1.023,00	288	20228110NM	254,00	323
20016203	390,00	124	20020501OM	427,00	119	20210301D	216,00	63	20225053NM	1.023,00	288	20228110OM	254,00	323
20016203AC	605,00	124	20020501OR	427,00	119	20210301KMB	299,00	63	20225053OM	1.399,00	288	20228110OR	254,00	323
20016203BM	605,00	124	20020502	215,00	119	20210301NM	299,00	63	20225053OR	1.399,00	288	2030021	170,0	

Referencia	€		Referencia	€		Referencia	€		Referencia	€		Referencia	€	
20230023AC	287,00	67	20340301	179,00	172	20827310	95,00	405	211167010M	508,00	148	21125004BM	849,00	287
20230023BM	287,00	67	20370301	168,00	172	20827810	80,00	405	211167010P	508,00	148	21125004KM	849,00	287
20230023NM	287,00	67	20417701	95,00	199	20828110	90,00	405	211167010PM	508,00	148	21125004KMB	849,00	287
20230023OM	287,00	67	20418001	135,00	199	20830002	85,00	405	211167010R	508,00	148	21125004NM	849,00	287
20230023OR	287,00	67	20418002	375,00	199				21117001	252,00	148	21125004OP	1.153,00	287
20230024	195,00	67	20418005	354,00	200				21117001AC	391,00	148	211250040M	1.153,00	287
20230024AC	302,00	67	20425001	90,00	202				21117001BM	391,00	148	21125004OPM	1.153,00	287
20230024BM	302,00	67	20425003	496,00	202				21117001KM	391,00	148	21125004OR	1.153,00	287
20230024NM	302,00	67	20425004	526,00	202				21117001KMB	391,00	148	21125005	785,00	286
20230024OM	429,00	67	20425005	805,00	203				21117001NM	391,00	148	21125005AC	1.147,00	286
20230024OR	429,00	67	20425006	510,00	203				211170010M	554,00	148	21125005BM	1.147,00	286
20230031	205,00	65	20427810	63,00	197				211170010P	554,00	148	21125005KM	1.147,00	286
20230031AC	318,00	65	20428003	337,00	198				211170010PM	554,00	148	21125005KMB	1.147,00	286
20230031BM	318,00	65	20428004	364,00	197				211170010R	554,00	148	21125005NM	1.147,00	286
20230031KMB	318,00	65	20428005	603,00	198				21118221	45,00	395	211250050M	1.575,00	286
20230031NM	318,00	65	20428006	310,00	198				21118221AC	70,00	395	211250050P	1.575,00	286
202300310M	451,00	65	20428110	79,00	197				21118221BM	70,00	395	211250050PM	1.575,00	286
202300310R	451,00	65	20510301	107,00	185				21118221KM	70,00	395	21125005OR	1.575,00	286
20230032	215,00	65	20510301D	130,00	185				21118221KMB	70,00	395	21125006	1.140,00	291
20230032AC	333,00	65	20510303	210,00	185				21118221NM	70,00	395	21125006AC	1.696,00	291
20230032BM	333,00	65	20511201	119,00	470				211182210M	99,00	395	21125006BM	1.696,00	291
20230032KMB	333,00	65	20511202	161,00	470				211182210P	99,00	395	21125006KM	1.696,00	291
20230032NM	333,00	65	20512001	110,00	186				211182210PM	99,00	395	21125006KMB	1.696,00	291
20230032OM	473,00	65	20512001D	133,00	186				211182210R	99,00	395	21125006NM	1.696,00	291
20230032OR	473,00	65	20516101	320,00	191				21120301	233,00	143	211250060M	2.355,00	291
20230033	220,00	66	20516103	310,00	190				21120301AC	361,00	143	211250060P	2.355,00	291
20230033AC	341,00	66	20516701	137,00	187				21120301BM	361,00	143	211250060PM	2.355,00	291
20230033BM	341,00	66	20517001	158,00	187				21120301KM	361,00	143	21125006OR	2.355,00	291
20230033NM	341,00	66	20517701	97,00	189				21120301KMB	361,00	143	21125007	445,00	292
20230033OM	484,00	66	20518001	139,00	189				21120301NM	361,00	143	21125007AC	621,00	292
20230033OR	484,00	66	20518002	412,00	190				211203010M	513,00	143	21125007BM	621,00	292
20230034	240,00	66	20518006	418,00	189				21120301OP	513,00	143	21125007KM	621,00	292
20230034AC	372,00	66	20518007	391,00	190				211203010PM	513,00	143	21125007KMB	621,00	292
20230034BM	372,00	66	20518301	35,00	397				21120301OR	513,00	143	21125007NM	621,00	292
20230034NM	372,00	66	20518301NM	55,00	397				21120302	233,00	144	211250070M	828,00	292
20230034OM	528,00	66	20522201	231,00	121				21120302AC	361,00	144	211250070P	828,00	292
20230034OR	528,00	66	20522201AC	358,00	121				21120302BM	361,00	144	211250070PM	828,00	292
20247001	1.660,00	72	20522201BM	358,00	121				21120302KM	361,00	144	21125007OR	828,00	292
20247001AC	1.798,00	72	20522201NM	358,00	121				21120302KMB	361,00	144	21127810	79,00	323
20247001BM	1.798,00	72	20522301	189,00	121				21120302NM	361,00	144	21127810AC	122,00	323
20247001KMB	1.798,00	72	20522301AC	293,00	121				211203020M	513,00	144	21127810BM	122,00	323
20247001KM	1.798,00	72	20522301BM	293,00	121				21120302OP	513,00	144	21127810KM	122,00	323
20247001NM	1.798,00	72	20522301NM	293,00	121				21120302OPM	513,00	144	21127810KMB	122,00	323
20247001OM	2.552,00	72	20522301OR	416,00	121				21120302OR	513,00	144	21127810NM	122,00	323
20247001OP	2.552,00	72	205223010M	416,00	121				21120501	184,00	145	211278100M	173,00	323
20247001OPM	2.552,00	72	20527810	79,00	323				21120501AC	285,00	145	211278100P	173,00	323
20247001OR	2.552,00	72	20528003	428,00	330				21120501BM	285,00	145	211278100PM	173,00	323
20261310	357,00	419	20528004	452,00	328				21120501KM	285,00	145	21127810OR	173,00	323
20261310AC	553,00	419	20528005	905,00	332				21120501KMB	285,00	145	21128003	506,00	330
20261310BM	553,00	419	20528006	335,00	189				21120501NM	285,00	145	21128003AC	735,00	330
20261310NM	553,00	419	20528110	100,00	324				211205010M	404,00	145	21128003BM	735,00	330
20261310OM	785,00	419	20530021	135,00	186				211205010P	404,00	145	21128003KM	735,00	330
20261310OR	785,00	419	20530022	145,00	186				211205010PM	404,00	145	21128003KMB	735,00	330
20261320	399,00	422	20530031	125,00	185				21120501OR	404,00	145	21128003NM	735,00	330
20261320AC	618,00	422	20530032	135,00	185				211205010R	200,00	147	211280030M	1.007,00	330
20261320BM	618,00	422	20544001	228,00	439				21122401AC	309,00	147	211280030P	1.007,00	330
20261320NM	618,00	422	20544001AC	353,00	439				21122401BM	309,00	147	211280030PM	1.007,00	330
20261320OM	878,00	422	20544001BM	353,00	439				21122401KM	309,00	147	21128003OR	1.007,00	330
20261320OR	878,00	422	20544001NM	353,00	439				21122401KMB	309,00	147	21128004	540,00	327
20285301	660,00	65	205440010M	502,00	439				21122401NM	309,00	147	21128004AC	787,00	327
20285301AC	1.023,00	65	20548601	250,00	436				211224010M	439,00	147	21128004BM	787,00	327
20285301BM	1.023,00	65	20548601AC	388,00	436				211224010P	439,00	147	21128004KM	787,00	327
20285301KM	1.023,00	65	20548601BM	388,00	436				211224010PM	439,00	147	21128004KMB	787,00	327
20285301KMB	1.023,00	65	20548601NM	388,00	436				21122401OR	439,00	147	21128004NM	787,00	327
20285301NM	1.023,00	65	205486010M	550,00	436				21125001	116,00	284	211280040M	1.081,00	327
20285301OM	1.452,00	65	20548702	435,00	451				21125001AC	179,00	284	211280040P	1.081,00	327
202853010P	1.452,00	65	20548702AC	674,00	451				21125001BM	179,00	284	211280040PM	1.081,00	327
202853010PM	1.452,00	65	20548702BM	674,00	451				21125001KM	179,00	284	21128004OR	1.081,00	327
202853010R	1.452,00	65	20548702NM	674,00	451				21125001KMB	179,00	284	21128005	731,00	328
20310301	88,00	171	20560301	310,00	419				21125001NM	179,00	284	21128005AC	1.085,00	328
20310301D	111,00	171	20560302	352,00	422				211250010M	254,00	284	21128005BM	1.085,00	328
20312001	91,00	173	20718107	160,00	499				211250010P	254,00	284	21128005KM	1.085,00	328
20316101	340,00	179	20718107AC	248,00	499				211250010PM	254,00	284	21128005KMB	1.085,00	328
20316102	330,00	179	20718107BM	248,00	499				21125001OR	254,00	284	21128005NM	1.085,00	328
20317701	100,00	178	207181070M	248,00	499				211250010R	254,00	284	211280050M	1.504,00	328
20318001	152,00	178	207181070M	352,00	499				21125003	805,00	289	211280050P	1.504,00	328
20318002	401,00	178	20718107OR	352,00	499				21125003AC	805,00	289	211280050PM	1.504,00	328
20320002	252,00	173	20718221	75,00	395				21125003BM	805,00	289	21128005OR	1.504,00	328
20321001	242,00	172	20718221AC	116,00	395				21125003KM	805,00	289	21128006	1.086,00	332
20322401	171,00	173	20718221BM	116,00	395				21125003KMB	805,00	289	21128006AC	1.634,00	332
20324501	415,00	406	207182210M	116,00	395				21125003NM	805,00	289	21128006BM	1.634,00	332
203														

LISTADO DE REFERENCIAS

Referencia	€		Referencia	€		Referencia	€		Referencia	€		Referencia	€	
21128006OPM	2.282,00	332	21150301KMB	163,00	146	21552001	16,00	479	21816701	118,00	210	23045302	250,00	447
21128006OR	2.282,00	332	21150301NM	163,00	146	21552002	20,00	479	21817001	139,00	210	23045302NM	388,00	447
21128007	394,00	334	21150301OM	231,00	146	21599002	248,00	247	21819101	300,00	211	23045303	250,00	447
21128007AC	560,00	334	21150301OP	231,00	146	2161030111	97,00	476	21820301	147,00	207	23045303NM	388,00	447
21128007BM	560,00	334	21150301OPM	231,00	146	21610303	60,00	231	21820303	145,00	207	23045402	311,00	446
21128007KM	560,00	334	21150301OR	231,00	146	21610303DA	74,00	231	21826701	98,00	209	23045402NM	434,00	446
21128007KMB	560,00	334	21180301	268,00	143	21610303NM	93,00	231	21827001	118,00	210	23045403	311,00	446
21128007NM	560,00	334	21180301AC	415,00	143	21610310	62,00	231	21827810	63,00	211	23045403NM	434,00	446
21128007OM	758,00	334	21180301BM	415,00	143	21610410	68,00	231	21828003	343,00	212	23048701	330,00	451
21128007OP	758,00	334	21180301KM	415,00	143	2161041011BR1	100,00	476	21828004	370,00	212	23048701OM	726,00	451
21128007OPM	758,00	334	21180301KMB	415,00	143	21612010	63,00	232	21828005	592,00	213	23048701OPM	726,00	451
21128007OR	758,00	334	21180301NM	415,00	143	21612010DA	77,00	232	21828006	340,00	213	23048702	360,00	451
21128110	100,00	324	21180301OM	589,00	143	21612010NM	97,00	232	21828110	79,00	212	23048702NM	558,00	451
21128110AC	155,00	324	21180301OP	589,00	143	21616401	139,00	235	21830010	45,00	521	23048702OM	792,00	451
21128110BM	155,00	324	21180301OPM	589,00	143	21616401NM	215,00	235	21830023	108,00	208	23048702OPM	792,00	451
21128110KM	155,00	324	21180301OR	589,00	143	21616409	153,00	235	21830024	118,00	209	23050301	150,00	447
21128110KMB	155,00	324	21180302	268,00	144	21616409NM	238,00	235	21830801	134,00	208	23050301NM	233,00	447
21128110NM	155,00	324	21180302AC	415,00	144	21616710	89,00	232	21830802	128,00	208	23050301OM	330,00	447
21128110OM	219,00	324	21180302BM	415,00	144	21616710NM	138,00	232	21831221	417,00	211	23050301OPM	330,00	447
21128110OP	219,00	324	21180302KM	415,00	144	21617010	112,00	233	21880301	180,00	208	23050302	60,00	447
21128110OPM	219,00	324	21180302KMB	415,00	144	21617010NM	174,00	233	21899501	255,00	210	23050401	243,00	446
21128110OR	219,00	324	21180302NM	415,00	144	21617701	90,00	235				23050401NM	344,00	446
21130021	140,00	146	21180302OM	589,00	144	21618001	126,00	235				23050401OM	481,00	446
21130021AC	217,00	146	21180302OP	589,00	144	21618221	44,00	396	22010301	85,00	195	23050401OPM	481,00	446
21130021BM	217,00	146	21180302OPM	589,00	144	21619110	289,00	233	22010401	93,00	195	23050402	162,00	446
21130021KM	217,00	146	21190401	208,00	144	21619601	249,00	235	22012001	88,00	196	23444005	7,00	518
21130021KMB	217,00	146	21190401AC	322,00	144	21619601NM	363,00	235	22016701	120,00	196	23461013	6,00	518
21130021NM	217,00	146	21190401BM	322,00	144	21619602	302,00	236	22017001	140,00	196	23461015	6,00	518
21130021OM	308,00	146	21190401KM	322,00	144	21625001	85,00	238	22020401	155,00	195	23461038	6,00	519
21130021OP	308,00	146	21190401KMB	322,00	144	21625001NM	130,00	238	22030021	200,00	195	23461050	6,00	518
21130021OPM	308,00	146	21190401NM	322,00	144	21625004	498,00	238	22030022	210,00	196	23461301	6,00	518
21130021OR	308,00	146	21190401NM	322,00	144	21625004NM	772,00	238				23461303	6,00	518
21130022	150,00	147	21190401OM	457,00	144	21626710	75,00	232				23461305	8,00	518
21130022AC	233,00	147	21190401OP	457,00	144	21627010	98,00	233	23033502	220,00	450	23461380	6,00	519
21130022BM	233,00	147	21190401OPM	457,00	144	21627810	58,00	234	23033502AC	341,00	450	23461501	6,00	518
21130022KM	233,00	147	21190401OR	457,00	144	21628004	344,00	234	23033502BM	341,00	450	23466001	6,00	518
21130022KMB	233,00	147	21190501	218,00	144	21628110	74,00	234	23033502NM	341,00	450	23466203	6,00	518
21130022NM	233,00	147	21190501AC	339,00	144	21631221	389,00	233	23033502OM	484,00	450	23466205	6,00	518
21130022OM	330,00	147	21190501BM	339,00	144	2163200311	164,00	476	23033502OPM	484,00	450	23466905	6,00	519
21130022OP	330,00	147	21190501KM	339,00	144	21632010	84,00	460	23033503	240,00	450	23466938	6,00	519
21130022OPM	330,00	147	21190501KMB	339,00	144	21632020	86,00	460	23033503AC	372,00	450	23467205	6,00	519
21130022OR	330,00	147	21190501NM	339,00	144	21632030	88,00	460	23033503BM	372,00	450	23467238	6,00	519
21130031	175,00	146	21190501OM	480,00	144	21639301	315,00	236	23033503NM	372,00	450	23468301	9,00	519
21130031AC	271,00	146	21190501OP	480,00	144	21639302NM	488,00	236	23033503OM	528,00	450	23468303	9,00	519
21130031BM	271,00	146	21190501OPM	480,00	144	21639502NM	628,00	237	23033503OPM	528,00	450			
21130031KM	271,00	146	21190501OR	480,00	144	21639521	405,00	237	23043801	340,00	452			
21130031KMB	271,00	146	21190601	229,00	145	21642010	98,00	462	23043802	300,00	453	24210201	273,00	43
21130031NM	271,00	146	21190601AC	355,00	145	21644010	83,00	440	23043802AC	465,00	453	24210201AC	423,00	43
21130031OM	385,00	146	21190601BM	355,00	145	21644020	89,00	440	23043802NM	465,00	453	24210201LM	396,00	43
21130031OP	385,00	146	21190601KM	355,00	145	21644710	78,00	443	23043803	260,00	452	24210201LV	396,00	43
21130031OPM	385,00	146	21190601KMB	355,00	145	21644720	84,00	443	23043803AC	403,00	452	24210201OR	601,00	43
21130031OR	385,00	146	21190601NM	355,00	145	21710301	79,00	523	23043803NM	403,00	452	24210301	215,00	43
21130032	185,00	146	21190601OM	504,00	145	21710303	77,00	523	23043804	190,00	453	24210301AC	334,00	43
21130032AC	287,00	146	21190601OP	504,00	145	21710401	85,00	523	23043804NM	295,00	453	24210301LM	312,00	43
21130032BM	287,00	146	21190601OPM	504,00	145	21712001	80,00	220	23043840	107,00	454	24210301LV	312,00	43
21130032KM	287,00	146	21190601OR	504,00	145	21712301	175,00	220	23044002	245,00	436	24210301OR	474,00	43
21130032KMB	287,00	146	21210001	45,00	472	21716401	182,00	224	23044002AC	380,00	436	24210501	383,00	44
21130032NM	287,00	146	21210301	61,00	471	21716409	227,00	224	23044002BM	380,00	436	24210501AC	594,00	44
21130032OM	407,00	146	21220001	40,00	472	21716701	103,00	221	23044002NM	380,00	436	24210501LM	556,00	44
21130032OP	407,00	146	21510303	53,00	243	21717001	123,00	221	23044002OM	539,00	436	24210501LV	556,00	44
21130032OPM	407,00	146	21510303D	63,00	243	21717419	302,00	224	23044002OPM	539,00	436	24210501OR	843,00	44
21130032OR	407,00	146	21510303DA	69,00	243	21717701	95,00	223	23044003	220,00	438	24210601	326,00	44
21130501	205,00	145	21510310	56,00	243	21718001	136,00	223	23044003AC	341,00	438	24210601AC	505,00	44
21130501AC	317,00	145	21510310D	66,00	243	21719101	293,00	222	23044003BM	341,00	438	24210601LM	472,00	44
21130501BM	317,00	145	21510410	62,00	244	21720301	144,00	219	23044003NM	341,00	438	24210601LV	472,00	44
21130501KM	317,00	145	21510410D	72,00	244	21720303	142,00	219	23044003OM	484,00	438	24210601OR	716,00	44
21130501KMB	317,00	145	21512010	56,00	244	21725001	90,00	214	23044003OPM	484,00	438	24210801	252,00	43
21130501NM	317,00	145	21512010D	66,00	244	21725003	482,00	215	23044005	125,00	438	24210801AC	391,00	43
21130501OM	450,00	145	21512010DA	70,00	244	21725004	512,00	214	23044005AC	194,00	438	24210801LM	365,00	43
21130501OP	450,00	145	21516710	87,00	245	21725005	790,00	215	23044005NM	194,00	438	24210801LV	365,00	43
21130501OPM	450,00	145	2151671011	125,00	477	21725006	495,00	215	23044006	160,00	437	24210801OR	554,00	43
21130501OR	450,00	145	21517010	102,00	245	21726701	82,00	221	23044006AC	248,00	437	24210901	179,00	43
21140501	226,00	145	21517701	82,00	246	21727001	103,00	221	23044006NM	248,00	437	24210901AC	277,00	43
21140501AC	350,00	145	21518001	118,00	246	21727810	63,00	222	23044007	140,00	438	2421090		

Referencia	€	U	Referencia	€	U	Referencia	€	U	Referencia	€	U	Referencia	€	U
24212101	284,00	46	24217602LM	1.291,00	47	24222001AC	395,00	45	24284001KMB	76,00	482	26110501OPM	520,00	81
24212101AC	439,00	46	24217602LV	1.291,00	47	24222001LM	370,00	45	24284001LM	71,00	482	26110501OR	520,00	81
24212101LM	411,00	46	24217609	683,00	52	24222001LV	370,00	45	24284001LV	71,00	482	26110502	252,00	81
24212101LV	411,00	46	24217609AC	1.058,00	52	24222001OR	561,00	45	24284001NE	76,00	482	26110502AC	391,00	81
24212101OR	624,00	46	24217609LM	990,00	52	24230601	106,00	45	24284001NM	76,00	482	26110502BM	391,00	81
24212201	186,00	45	24217609LV	990,00	52	24230601AC	164,00	45	24284001OM	108,00	482	26110502KM	391,00	81
24212201AC	288,00	45	24217609OR	1.502,00	52	24230601LM	154,00	45	24284001OP	108,00	482	26110502KMB	391,00	81
24212201LM	269,00	45	24217701	116,00	48	24230601LV	154,00	45	24284001OPM	108,00	482	26110502NM	391,00	81
24212201LV	269,00	45	24217701AC	179,00	48	24230601OR	233,00	45	24284001OR	108,00	482	26110502OP	554,00	81
24212201OR	409,00	45	24217701LM	167,00	48	24231001	230,00	456	24284001RO	76,00	482	26110502OPM	554,00	81
24212202	289,00	46	24217701LV	167,00	48	24231001AC	357,00	456	24284002	46,00	482	26110502OR	554,00	81
24212202AC	448,00	46	24217701OR	254,00	48	24231001LM	334,00	456	24284002AC	71,00	482	26112001	176,00	84
24212202LM	419,00	46	24217703	566,00	49	24231001LV	334,00	456	24284002BL	71,00	482	2612001D	200,00	84
24212202OR	635,00	46	24217703AC	906,00	49	24231001OR	506,00	456	24284002BM	71,00	482	26116701	278,00	85
24214501	467,00	50	24217703LM	821,00	49	24233401	400,00	450	24284002KM	71,00	482	26116701AC	431,00	85
24214501AC	724,00	50	24217703LV	821,00	49	24233401AC	620,00	450	24284002KMB	71,00	482	26116701BM	431,00	85
24214501LM	678,00	50	24218001	179,00	48	24233401LM	580,00	450	24284002LV	66,00	482	26116701KM	431,00	85
24214501LV	678,00	50	24218001AC	277,00	48	24233401LV	580,00	450	24284002NE	71,00	482	26116701KMB	431,00	85
24214501OR	1.028,00	50	24218001LM	259,00	48	24233401OR	880,00	450	24284002NM	71,00	482	26116701NM	431,00	85
24214601	610,00	50	24218001LV	259,00	48	24234101	321,00	438	24284002OM	101,00	482	26116701OPM	612,00	85
24214601AC	945,00	50	24218001OR	393,00	48	24234101AC	498,00	438	24284002OP	101,00	482	26116701OPM	612,00	85
24214601LM	884,00	50	24218003	638,00	48	24234101LM	465,00	438	24284002OPM	101,00	482	26116701OR	612,00	85
24214601LV	884,00	50	24218003AC	991,00	48	24234101LV	465,00	438	24284002OR	101,00	482	26116701TAM	431,00	85
24214601OR	1.342,00	50	24218003LM	925,00	48	24234101OR	706,00	438	24284010	52,00	482	26116701TRO	431,00	85
24214602	583,00	50	24218003LV	925,00	48	24234201	237,00	456	24284010AC	81,00	482	26117001	299,00	85
24214602AC	903,00	50	24218003OR	1.480,00	48	24234201AC	367,00	456	24284010AM	81,00	482	26117001AC	464,00	85
24214602LM	845,00	50	24218004	604,00	48	24234201LM	344,00	456	24284010BL	81,00	482	26117001BM	464,00	85
24214602LV	845,00	50	24218004AC	936,00	48	24234201LV	344,00	456	24284010BM	81,00	482	26117001KMB	464,00	85
24214602OR	1.282,00	50	24218004LM	876,00	48	24234201OR	521,00	456	24284010KM	81,00	482	26117001NM	464,00	85
24215101	284,00	44	24218004LV	876,00	48	24235201	786,00	54	24284010KMB	81,00	482	26117001OPM	658,00	85
24215101AC	439,00	44	24218004OR	1.399,00	48	24235201AC	1.218,00	54	24284010LM	75,00	482	26117001OPM	658,00	85
24215101LM	411,00	44	24218005	400,00	49	24235201LM	1.140,00	54	24284010LV	75,00	482	26117001TAM	464,00	85
24215101LV	411,00	44	24218005AC	620,00	49	24235201LV	1.140,00	54	24284010NE	81,00	482	26118221	42,00	396
24215101OR	624,00	44	24218005LM	580,00	49	24235201OR	1.729,00	54	24284010NM	81,00	482	26118221AC	65,00	396
24215102	305,00	44	24218005LV	580,00	49	24235202AC	1.564,00	54	24284010OP	114,00	482	26118221BM	65,00	396
24215102AC	472,00	44	24218005OR	880,00	49	24235202LM	1.463,00	54	24284010OPM	114,00	482	26118221KM	65,00	396
24215102LM	442,00	44	24218006	678,00	49	24235202LV	1.463,00	54	24284010OR	114,00	482	26118221KMB	65,00	396
24215102LV	442,00	44	24218006AC	1.051,00	49	24235202OR	2.220,00	54	24284010RO	79,00	482	26118221NM	65,00	396
24215102OR	670,00	44	24218006LM	984,00	49	24235203	1.021,00	53	24284020	49,00	483	26118221OPM	92,00	396
24215501	93,00	496	24218006LV	984,00	49	24235203AC	1.583,00	53	24284020AC	76,00	483	26118221OPM	92,00	396
24215501AC	145,00	496	24218201	71,00	397	24235203LM	1.480,00	53	24284020BL	76,00	483	26130701	312,00	80
24215501LM	136,00	496	24218201AC	111,00	397	24235203LV	1.480,00	53	24284020BM	76,00	483	26130701AC	483,00	80
24215501LV	136,00	496	24218201LM	104,00	397	24235301	1.330,00	54	24284020KMB	76,00	483	26130701BM	483,00	80
24215501OR	206,00	496	24218201LV	104,00	397	24235301AC	2.062,00	54	24284020LM	71,00	483	26130701KMB	483,00	80
24215502	93,00	497	24219101	1.003,00	47	24235301LM	1.929,00	54	24284020LV	71,00	483	26130701NM	483,00	80
24215502AC	145,00	497	24219101AC	1.555,00	47	24235301LV	1.929,00	54	24284020NE	76,00	483	26130701OPM	686,00	80
24215502LM	136,00	497	24219101LM	1.454,00	47	24244101	210,00	438	24284020NM	107,00	483	26130701OPM	686,00	80
24215502LV	136,00	497	24219101LV	1.454,00	47	24244101AC	326,00	438	24284020OP	107,00	483	26130701OPM	686,00	80
24215502OR	206,00	497	24219401	459,00	51	24244101LM	305,00	438	24284020OPM	107,00	483	26130701TAM	483,00	80
24216301	294,00	46	24219401AC	711,00	51	24244101LV	305,00	438	24284020OR	107,00	483	26130801	341,00	80
24216301AC	456,00	46	24219401LM	665,00	51	24244101OR	462,00	438	24287101	154,00	498	26130801AC	529,00	80
24216301LM	426,00	46	24219401LV	665,00	51	24247601	494,00	58	24287101AC	239,00	498	26130801BM	529,00	80
24216301LV	426,00	46	24219401OR	1.009,00	51	24247601AC	765,00	58	24287101LM	223,00	498	26130801KMB	529,00	80
24216301OR	647,00	46	24219402	648,00	51	24247601LM	716,00	58	24287101LV	223,00	498	26130801NM	529,00	80
24216402	625,00	52	24219402AC	1.004,00	51	24247601LV	716,00	58	24287101OR	223,00	498	26130801OPM	751,00	80
24216402AC	969,00	52	24219402LM	939,00	51	24247602	481,00	57	24287101TAM	483,00	80	26130801OPM	751,00	80
24216402LM	906,00	52	24219402LV	939,00	51	24247602AC	745,00	57	26130701TRO	483,00	80	26130801TAM	483,00	80
24216402LV	906,00	52	24219403	350,00	497	24247602LM	697,00	57	26130801TRO	483,00	80	26130801TRO	483,00	80
24216409	488,00	51	24219403AC	543,00	497	24247602LV	697,00	57	25477001	13,00	506	26130801TAM	483,00	80
24216409AC	757,00	51	24219403LM	508,00	497	24250001	88,00	56	25477002	12,00	506	26130801TAM	483,00	80
24216409LM	708,00	51	24219403LV	508,00	497	24250001AC	136,00	56	25477003	10,00	507	26130801TAM	483,00	80
24216409LV	708,00	51	24219403OM	770,00	497	24250001LM	127,00	56	25477004	9,00	506	26130801TAM	483,00	80
24216409OR	1.074,00	51	24219501	867,00	52	24250001OR	193,00	56	25477005	14,00	507	26130801TAM	483,00	80
24216701	305,00	46	24219501AC	1.344,00	52	24250301	104,00	45	25477006	3,00	508	26130801TAM	483,00	80
24216701AC	472,00	46	24219501LM	1.257,00	52	24250301AC	156,00	45	25477007	14,00	506	26130801TAM	483,00	80
24216701LM	442,00	46	24219501LV	1.257,00	52	24250301LM	146,00	45	25477008	5,00	508	26130801TAM	483,00	80
24216701LV	442,00	46	24219502	1.039,00	53	24250301LV	146,00	45	25477009	16,00	507	26130801TAM	483,00	80
24216701OR	670,00	46	24219502AC	1.610,00	53	24250301OR	222,00	45	25477010	3,00	508	26130801TAM	483,00	80
24217001	352,00	46	24219502LM	1.507,00	53	24252001	103,00	56	25477011	4,00	508	26130801TAM	483,00	80
24217001AC	545,00	46	24219502LV	1.507,00	53	24252001AC	159,00	56	25477012	13,00	507	26130801TAM	483,00	80
24217001LM	510,00	46	24219801	964,00	53	24252001LM	149,00	56	25477013	4,00	508	26130801TAM	483,00	80
24217001LV	510,00	46	24219801AC	1.494,00	53	24252001LV	149,00	56	25477014	39,00	509	26130801TAM	483,00	80
24217001OR	774,00	46	24219801LM	1.398,00	53	24252001OR	226,00	56	25477015	40,00	509	26130801TAM	483,00	80
24217409	541,00													

LISTADO DE REFERENCIAS

Referencia	€		Referencia	€		Referencia	€		Referencia	€		Referencia	€	
26212001D	200,00	84	26227302BM	946,00	335	26230021OPM	389,00	83	26285306	578,00	82	28117001	263,00	134
26215001	450,00	166	26227302KM	946,00	335	26230021OR	389,00	83	26285306AC	895,00	82	28117001AC	407,00	134
26218004	102,00	500	26227302KMB	946,00	335	26230022	187,00	83	26285306BM	895,00	82	28117001NM	407,00	134
26218004AC	158,00	500	26227302NM	946,00	335	26230022AC	290,00	83	26285306KM	895,00	82	28117001OPM	578,00	134
26218004BM	158,00	500	26227302OM	1.304,00	335	26230022BM	290,00	83	26285306KMB	895,00	82	28119101	497,00	135
26218004KM	158,00	500	26227302OP	1.304,00	335	26230022KM	290,00	83	26285306NM	895,00	82	28119101AC	770,00	135
26218004KMB	158,00	500	26227302OPM	1.304,00	335	26230022KMB	290,00	83	26285306OM	1.271,00	82	28119101NM	770,00	135
26218004NM	158,00	500	26227302OR	1.304,00	335	26230022NM	290,00	83	26285306OP	1.271,00	82	28119101OPM	1.093,00	135
26218004OM	224,00	500	26227310	125,00	325	26230022OM	411,00	83	26285306OPM	1.271,00	82	28119701	528,00	135
26218004OP	224,00	500	26227310AC	194,00	325	26230022OP	411,00	83	26285306OR	1.271,00	82	28119701AC	819,00	135
26218004OPM	224,00	500	26227310BM	194,00	325	26230022OPM	411,00	83	26285350	189,00	404	28119701NM	819,00	135
26218004OR	224,00	500	26227310KM	194,00	325	26230022OR	411,00	83	26290301	173,00	79	28119701OPM	1.162,00	135
26222402	221,00	84	26227310KMB	194,00	325	26230031	215,00	83	26290301AC	269,00	79	28120301	236,00	132
26222402AC	342,00	84	26227310NM	194,00	325	26230031AC	333,00	83	26290301BM	269,00	79	28120301AC	366,00	132
26222402BM	342,00	84	26227310OM	275,00	325	26230031BM	333,00	83	26290301D	196,00	79	28120301NM	366,00	132
26222402KM	342,00	84	26227310OP	275,00	325	26230031BM	333,00	83	26290301OM	381,00	79	28120301OPM	520,00	132
26222402KMB	342,00	84	26227310OPM	275,00	325	26230031KM	333,00	83	26290301KMB	269,00	79	28125001	116,00	285
26222402NM	342,00	84	26227310OR	275,00	325	26230031KMB	333,00	83	26290301NM	269,00	79	28125001AC	179,00	285
26222402OM	485,00	84	26227810	89,00	322	26230031NM	333,00	83	26290301OPM	381,00	79	28125001NM	179,00	285
26222402OP	485,00	84	26227810AC	138,00	322	26230031OM	473,00	83	26290301OP	381,00	79	28125001OPM	254,00	285
26222402OPM	485,00	84	26227810BM	138,00	322	26230031OP	473,00	83	26290301OPM	381,00	79	28125003	538,00	290
26222402OR	485,00	84	26227810OBM	138,00	322	26230031OPM	473,00	83	26290301OR	381,00	79	28125003AC	766,00	290
26222402OTAM	485,00	84	26227810OKM	138,00	322	26230031OR	473,00	83	26290301OR	381,00	79	28125003AC	766,00	290
26222402TAM	342,00	84	26227810KMB	138,00	322	26230032	225,00	83	26290301TAM	269,00	79	28125003NM	766,00	290
26222402TRO	342,00	84	26227810NM	138,00	322	26230032AC	349,00	83	26290301TAM	269,00	79	28125004	566,00	288
26225001	137,00	285	26227810OM	196,00	322	26230032AC	349,00	83	26290401	242,00	81	28125004AC	806,00	288
26225001AC	212,00	285	26227810OP	196,00	322	26230032BM	349,00	83	26290401AC	374,00	81	28125004AC	806,00	288
26225001BM	212,00	285	26227810OPM	196,00	322	26230032KM	349,00	83	26290401AC	374,00	81	28125004NM	806,00	288
26225001KM	212,00	285	26227810OR	196,00	322	26230032KMB	349,00	83	26290401BM	374,00	81	28125004OPM	1.092,00	288
26225001KMB	212,00	285	26228003	473,00	329	26230032NM	349,00	83	26290401KM	374,00	81	28125005	1.145,00	291
26225001NM	212,00	285	26228003AC	675,00	329	26230032OM	495,00	83	26290401KMB	374,00	81	28125005AC	1.706,00	291
26225001OM	300,00	285	26228003BM	675,00	329	26230032OP	495,00	83	26290401NM	374,00	81	28125005NM	1.706,00	291
26225001OP	300,00	285	26228003KM	675,00	329	26230032OPM	495,00	83	26290401OM	531,00	81	28125005OPM	2.369,00	291
26225001OPM	300,00	285	26228003KMB	675,00	329	26230032OR	450,00	83	26290401OP	531,00	81	28125006	450,00	293
26225001OR	300,00	285	26228003NM	675,00	329	26230701	312,00	79	26290401OPM	531,00	81	28125006AC	633,00	293
26225003	558,00	289	26228003OM	924,00	329	26230701AC	483,00	79	26290401OR	531,00	81	28125006NM	633,00	293
26225003AC	797,00	289	26228003OP	924,00	329	26230701BM	483,00	79	26290401TAM	374,00	81	28127301	1.104,00	335
26225003BM	797,00	289	26228003OPM	924,00	329	26230701BM	483,00	79	26290401TAM	374,00	81	28127301AC	1.660,00	335
26225003KM	797,00	289	26228003OR	924,00	329	26230701KMB	483,00	79	26290402	231,00	80	28127301NM	1.660,00	335
26225003KMB	797,00	289	26228004	495,00	326	26230701KM	483,00	79	26290402AC	358,00	80	28127301OPM	2.318,00	335
26225003NM	797,00	289	26228004AC	712,00	326	26230701OM	686,00	79	26290402BM	358,00	80	28127302	1.180,00	336
26225003OM	1.078,00	289	26228004BM	712,00	326	26230701OP	686,00	79	26290402KM	358,00	80	28127302AC	1.780,00	336
26225003OP	1.078,00	289	26228004KM	712,00	326	26230701OPM	686,00	79	26290402KMB	358,00	80	28127302NM	1.780,00	336
26225003OPM	1.078,00	289	26228004KMB	712,00	326	26230701OR	686,00	79	26290402NM	358,00	80	28127302OPM	2.486,00	336
26225003OR	1.078,00	289	26228004NM	712,00	326	26230701OR	686,00	79	26290402OM	508,00	80	28127310	109,00	325
26225004	585,00	287	26228004OP	977,00	326	26230701TAM	483,00	79	26290402OP	508,00	80	28127310AC	169,00	325
26225004AC	837,00	287	26228004OPM	977,00	326	26230801	341,00	79	26290402OPM	508,00	80	28127310NM	169,00	325
26225004BM	837,00	287	26228004OR	977,00	326	26230801AC	529,00	79	26290402OR	508,00	80	28127310OPM	240,00	325
26225004KM	837,00	287	26228005	1.026,00	331	26230801AC	529,00	79	26290402TAM	358,00	80	28127810	79,00	322
26225004KMB	837,00	287	26228005AC	1.546,00	331	26230801BM	529,00	79	26290402TAM	358,00	80	28127810AC	122,00	322
26225004NM	837,00	287	26228005BM	1.546,00	331	26230801KMB	529,00	79	26290403	221,00	80	28127810NM	122,00	322
26225004OM	1.136,00	287	26228005KM	1.546,00	331	26230801KMB	529,00	79	26290403AC	342,00	80	28127810OPM	173,00	322
26225004OP	1.136,00	287	26228005KMB	1.546,00	331	26230801NM	529,00	79	26290403BM	342,00	80	28128004	474,00	327
26225004OPM	1.136,00	287	26228005NM	1.546,00	331	26230801OP	751,00	79	26290403KM	342,00	80	28128004AC	691,00	327
26225004OR	1.136,00	287	26228005OM	2.160,00	331	26230801OPM	751,00	79	26290403KMB	342,00	80	28128004NM	691,00	327
26225005	1.164,00	291	26228005OP	2.160,00	331	26230801OR	751,00	79	26290403NM	342,00	80	28128004OPM	947,00	327
26225005AC	1.737,00	291	26228005OPM	2.160,00	331	26230801TAM	529,00	79	26290403OM	485,00	80	28128110	100,00	324
26225005BM	1.737,00	291	26228005OR	2.160,00	331	26247005	1.103,00	89	26290403OP	485,00	80	28128110AC	155,00	324
26225005KM	1.737,00	291	26228006	381,00	333	26247005AC	1.709,00	89	26290403OPM	485,00	80	28128110NM	155,00	324
26225005KMB	1.737,00	291	26228006AC	545,00	333	26247005BM	1.709,00	89	26290403OR	485,00	80	28128110OPM	219,00	324
26225005NM	1.737,00	291	26228006BM	545,00	333	26247005KM	1.709,00	89	26290403TAM	342,00	80	28130021	145,00	133
26225005OM	2.412,00	291	26228006KMB	545,00	333	26247005KMB	1.709,00	89	26290403TRO	342,00	80	28130021AC	225,00	133
26225005OP	2.412,00	291	26228006NM	545,00	333	26247005NM	1.709,00	89				28130021NM	225,00	133
26225005OPM	2.412,00	291	26228006OM	740,00	333	26247005OP	2.426,00	89				28130021OPM	352,00	133
26225005OR	2.412,00	291	26228006OP	740,00	333	26247005OPM	2.426,00	89				28130022	155,00	133
26225006	470,00	293	26228006OPM	740,00	333	26247005OR	2.426,00	89				28130022AC	240,00	133
26225006AC	650,00	293	26228006OR	740,00	333	26247006	1.103,00	89				28130022NM	240,00	133
26225006BM	650,00	293	26228110	116,00	324	26247006AC	1.709,00	89				28130022OPM	341,00	133
26225006KMB	650,00	293	26228110AC	179,00	324	26247006BM	1.709,00	89				28130023	185,00	133
26225006NM	650,00	293	26228110BM	179,00	324	26247006KMB	1.709,00	89				28130023AC	287,00	133
26225006OM	850,00	293	26228110KMB	179,00	324	26247006NM	1.709,00	89				28130023NM	287,00	133
26225006OP	850,00	293	26228110KM	179,00	324	26247006OM	2.426,00	89				28130023OPM	407,00	133
26225006OPM	850,00	293	26228110KMB	179,00	324	26247006OP	2.426,00	89				28130024	195,00	

Referencia	€		Referencia	€		Referencia	€		Referencia	€		Referencia	€	
28184701	236,00	131	29933701OR	185,00	368	29963203OR	792,00	361	29990308BM	1.263,00	359	30725305OPM	3.083,00	278
28184701AC	366,00	131	29933702	60,00	369	29963206	135,00	363	29990308NM	1.263,00	359	30725305OR	3.083,00	278
28184701NM	366,00	131	29933702AC	93,00	369	29963901	10,00	394	29990308OM	1.793,00	359	30725306	1.477,00	278
28184701OPM	520,00	131	29933702LM	87,00	369	29963902	85,00	367	29990308OP	1.793,00	359	30725306AC	2.290,00	278
28190301	125,00	132	29933702LV	87,00	369	29963902AC	132,00	367	29990308OPM	1.793,00	359	30725306KMB	2.290,00	278
28190301AC	194,00	132	29933702OR	132,00	369	29963902BM	132,00	367	29990308OR	1.793,00	359	30725306NM	2.290,00	278
28190301NM	194,00	132	29933703	268,00	364	29963902KMB	132,00	367	29995001	38,00	174	30725306OM	3.250,00	278
28190301OPM	275,00	132	29933703AC	415,00	364	29963902NM	132,00	367	29995301	790,00	355	30725306OP	3.250,00	278
28310301	236,00	35	29933703LM	389,00	364	29963902OM	187,00	367	29995301AC	1.225,00	355	30725306OPM	3.250,00	278
28310301AC	366,00	35	29933703LV	389,00	364	29963902OP	187,00	367	29995301BM	1.225,00	355	30725306OR	3.250,00	278
28310301NM	366,00	35	29933703OR	590,00	364	29963902OPM	187,00	367	29995301NM	1.225,00	355	30725401	660,00	275
28310301OM	520,00	35	299392134	10,00	521	29963902OR	187,00	367	29995301OM	1.738,00	355	30725401AC	1.023,00	275
28310301OPM	520,00	35	29943801	54,00	364	29963910	40,00	394	29995301OR	1.738,00	355	30725401KMB	1.023,00	275
28310501	315,00	35	29944601	55,00	497	29963910AC	62,00	394	29995501	1.135,00	354	30725401NM	1.023,00	275
28310501AC	488,00	35	29945302	62,00	449	29963910LM	58,00	394	29995501AC	1.759,00	354	30725401OM	1.452,00	275
28310501NM	488,00	35	29945303	120,00	449	29963910LV	58,00	394	29995501BM	1.759,00	354	30725401OP	1.452,00	275
28310501OM	693,00	35	29945304	53,00	449	29963910OR	88,00	394	29995501NM	1.759,00	354	30725401OPM	1.452,00	275
28310501OPM	693,00	35	29951501	63,00	399	29963928	7,00	394	29995501OM	2.497,00	354	30725401OR	1.452,00	275
28312001	239,00	36	29951502	56,00	400	29966310	5,00	518	29995501OR	2.497,00	354	30725405	1.842,00	279
28312001AC	371,00	36	29951503	55,00	400	29974802	30,00	374	29995801	2.440,00	356	30725405AC	2.854,00	279
28312001NM	371,00	36	29951504	693,00	398	29974901	33,00	373	29996201	1.390,00	354	30725405KMB	2.854,00	279
28312001OM	527,00	36	29951504AC	1.074,00	398	29974904	45,00	372	29997001	1.440,00	354	30725405NM	2.854,00	279
28312001OPM	527,00	36	29951504BM	1.074,00	398	29974905	35,00	373	29997001AC	2.232,00	354	30725405OM	4.051,00	279
28316301	336,00	36	29951504NM	1.074,00	398	29974906	39,00	372	29997001BM	2.232,00	354	30725405OP	4.051,00	279
28316301AC	521,00	36	29951504OM	1.525,00	398	29985001	36,00	521	29997001NM	2.232,00	354	30725405OPM	4.051,00	279
28316301NM	521,00	36	29951504OR	1.525,00	398	29985002	40,00	521	29997001OM	3.168,00	354	30725405OR	4.051,00	279
28316301OM	739,00	36	29951505	709,00	398	29985003	50,00	521	29997001OR	3.168,00	354	30725406	1.918,00	279
28316301OPM	739,00	36	29951505AC	1.099,00	398	29987001	114,00	498	29997101	1.540,00	354	30725406AC	2.972,00	279
28317601	404,00	36	29951505BM	1.099,00	398	29987001AC	177,00	498	29997201	2.440,00	354	30725406KMB	2.972,00	279
28317601AC	627,00	36	29951505NM	1.099,00	398	29987001NM	177,00	498				30725406NM	2.972,00	279
28317601NM	627,00	36	29951505OM	1.559,00	398	29987001OM	251,00	498	30			30725406OP	4.219,00	279
28317601OM	889,00	36	29951505OR	1.559,00	398	29987001OPM	251,00	498	30725201	560,00	274	30725406OPM	4.219,00	279
28317601OPM	889,00	36	29951506	420,00	398	29987002	126,00	497	30725201AC	868,00	274	30725406OPM	4.219,00	279
28319401	578,00	37	29951507	436,00	398	29989601	19,00	521	30725201KMB	868,00	274	30725406OR	4.219,00	279
28319401AC	895,00	37	29951607	920,00	355	29989602	17,00	521	30725201NM	868,00	274	30735201	540,00	274
28319401NM	895,00	37	29951607AC	1.426,00	355	29989603	21,00	521	30725201OM	1.232,00	274	30735201AC	837,00	274
28319401OM	1.271,00	37	29951607BM	1.426,00	355	29990301	755,00	358	30725201OP	1.232,00	274	30735201KMB	837,00	274
28319401OPM	1.271,00	37	29951607NM	1.426,00	355	29990301AC	1.170,00	358	30725201OPM	1.232,00	274	30735201NM	837,00	274
28320301	252,00	35	29951607OM	2.024,00	355	29990301BM	1.170,00	358	30725201OR	1.232,00	274	30735201OM	1.188,00	274
28320301AC	391,00	35	29951607OR	2.024,00	355	29990301NM	1.170,00	358	30725204	782,00	276	30735201OP	1.188,00	274
28320301NM	391,00	35	29952505	16,00	495	29990301OM	1.661,00	358	30725204AC	1.210,00	276	30735201OPM	1.188,00	274
28320301OM	554,00	35	29953202	295,00	360	29990301OPM	1.661,00	358	30725204KMB	1.210,00	276	30735201OR	1.188,00	274
28320301OPM	554,00	35	29953303	31,00	520	29990301OR	1.661,00	358	30725204NM	1.210,00	276	30735204	811,00	276
28325001	179,00	284	29955304	31,00	520	29990302	555,00	359	30725204OM	1.718,00	276	30735204AC	1.163,00	276
28325001AC	277,00	284	29955306	13,00	520	29990302AC	860,00	359	30725204OP	1.718,00	276	30735204KMB	1.163,00	276
28325001NM	277,00	284	29961001	5,00	518	29990302BM	860,00	359	30725204OPM	1.718,00	276	30735204NM	1.163,00	276
28325001OM	393,00	284	29961002	6,00	518	29990302NM	860,00	359	30725204OR	1.718,00	276	30735204OM	1.651,00	276
28325001OPM	393,00	284	29961005	6,00	518	29990302OM	1.221,00	359	30725205	1.116,00	276	30735204OP	1.651,00	276
28325002	625,00	285	29961006	7,00	518	29990302OPM	1.221,00	359	30725205AC	1.730,00	276	30735204OPM	1.651,00	276
28325002AC	899,00	285	29963105	28,00	375	29990302OR	1.221,00	359	30725205KMB	1.730,00	276	30735204OR	1.651,00	276
28325002NM	899,00	285	29963106	25,00	374	29990303	455,00	359	30725205NM	1.730,00	276	30735206	1.329,00	277
28325002OM	1.224,00	285	29963108	21,00	371	29990303AC	705,00	359	30725205OM	2.456,00	276	30735206AC	1.966,00	277
28325002OPM	1.224,00	285	29963109	58,00	374	29990303BM	705,00	359	30725205OP	2.456,00	276	30735206KMB	1.966,00	277
28330001	289,00	35	29963109AC	90,00	374	29990303KM	705,00	359	30725205OPM	2.456,00	276	30735206NM	1.966,00	277
28330001AC	448,00	35	29963109LM	84,00	374	29990303KMB	705,00	359	30725205OR	2.456,00	276	30735206OM	2.790,00	277
28330001NM	448,00	35	29963109LV	84,00	374	29990303NM	705,00	359	30725206	1.315,00	277	30735206OP	2.790,00	277
28330001OM	635,00	35	29963109OR	145,00	374	29990303OM	1.001,00	359	30725206AC	1.855,00	277	30735206OPM	2.790,00	277
28330001OPM	635,00	35	29963110	16,00	375	29990303OP	1.001,00	359	30725206KMB	1.855,00	277	30735206OR	2.790,00	277
28330002	299,00	36	29963111	26,00	373	29990303OPM	1.001,00	359	30725206NM	1.855,00	277	30735301	640,00	274
28330002AC	464,00	36	29963112	41,00	372	29990303OR	1.001,00	359	30725206OM	2.895,00	277	30735301AC	992,00	274
28330002NM	464,00	36	29963112AC	64,00	372	29990304	450,00	360	30725206OP	2.895,00	277	30735301KMB	992,00	274
28330002OM	658,00	36	29963112BM	64,00	372	29990304AC	698,00	360	30725206OPM	2.895,00	277	30735301NM	992,00	274
28330002OPM	658,00	36	29963112KM	64,00	372	29990304BM	698,00	360	30725206OR	2.895,00	277	30735301OM	1.408,00	274
28380301	294,00	35	29963112KMB	64,00	372	29990304KMB	698,00	360	30725207	1.197,00	278	30735301OP	1.408,00	274
28380301AC	456,00	35	29963112NM	64,00	372	29990304NM	698,00	360	30725207AC	1.855,00	278	30735301OPM	1.408,00	274
28380301NM	456,00	35	29963112OM	90,00	372	29990304OM	990,00	360	30725207KMB	1.855,00	278	30735301OR	1.408,00	274
28380301OM	647,00	35	29963112OP	90,00	372	29990304OPM	990,00	360	30725207NM	1.855,00	278	30735401	640,00	275
28380301OPM	647,00	35	29963112OPM	90,00	372	29990304OR	990,00	360	30725207OM	2.633,00	278	30735401AC	992,00	275
			29963112OR	90,00	372	29990306	515,00	359	30725207OP	2.633,00	278	30735401KMB	992,00	275
29			29963113	43,00	372	29990306AC	798,00	359	30725207OPM	2.633,00	278	30735401NM	992,00	275
29908405	11,00	520	29963113AC	67,00	372	29990306BM	798,00	359	30725207OR	2.633,00	278	30735401OM	1.408,00	275
29908406	10,00	520	29963113BM											

LISTADO DE REFERENCIAS

Referencia	€		Referencia	€		Referencia	€	
39210320	515,00	421	9134591	40,00	519	913480810	19,00	370
39210390	254,00	424	9134592	40,00	519	913481810	26,00	369
39210391	204,00	424	9134609	24,00	377	9134828	18,00	378
39210397	250,00	424	913460910	21,00	377	9134830051	82,00	378
39210399	300,00	424	913460912	23,00	377	9134830053	82,00	378
39274101	310,00	425	913460912AC	35,00	377	9134830054	164,00	378
39274101NM	480,00	425	913460912BM	35,00	377	913483005LM	82,00	378
39274102	315,00	425	913460912KM	35,00	377	913483080	20,00	378
39274201	202,00	426	913460912KMB	35,00	377	913484005	4,00	520
39274201AC	202,00	426	913460912NM	35,00	377	9134840061	9,00	520
39274201BL	202,00	426	913460912OM	51,00	377	913484007	9,00	520
49			913460912OP	51,00	377	913484016	11,00	520
49286299	1.040,00	268	913460912OPM	51,00	377	913484026	16,00	520
49286398	1.113,00	269	913460912OR	51,00	377	913484057	25,00	520
49286399	1.113,00	269	913460915	23,00	377	9134841	10,00	395
49286499	1.187,00	269	913460915AC	35,00	377	9134849	31,00	519
49288299	1.040,00	268	913460915BM	35,00	377	9134867	33,00	378
49288398	1.113,00	269	913460915KM	35,00	377	9134872	35,00	521
49288399	1.113,00	269	913460915KMB	35,00	377	9134880	28,00	519
49288499	1.187,00	269	913460915NM	35,00	377	9134881	33,00	379
50			913460915OM	51,00	377	9134882	7,00	521
50643703	646,00	452	913460915OP	51,00	377	9134887	35,00	379
50648603	651,00	436	913460915OPM	51,00	377	9134890	11,00	521
50716703	485,00	104	913460915OR	51,00	377	9134891	6,00	521
5071700203	518,00	104	913460920	24,00	377	9134893	3,00	521
50783903	48,00	394	9134609AC	36,00	377	9134895	3,00	521
52			9134609BM	36,00	377	9134896	3,00	521
5246360951	113,00	412	9134609KM	36,00	377	9134897	3,00	521
53			9134609KMB	36,00	377	9134898	3,00	521
53049603	471,00	436	9134609NM	36,00	377	9134915	36,00	400
56			9134609OM	52,00	377	916110348	36,00	488
56243703	415,00	453	9134609OP	52,00	377	9161515	129,00	399
56244003	310,00	439	9134609OPM	52,00	377	916184010	20,00	520
91			9134609OR	52,00	377	916184060	28,00	488
9106006	9,00	518	9134615	29,00	400	916218005	31,00	520
910618020	31,00	520	9134630	15,00	378	9162292	15,00	520
910719005	40,00	519	913463250	18,00	494	9174441	30,00	519
9107515	134,00	399	913463320	15,00	494	919260634	11,00	520
9107672	14,00	518	913463320AC	23,00	494	919416401	3,00	521
913010334	7,00	521	913463320BM	23,00	494	9194283	46,00	519
9130190	40,00	519	913463320KM	23,00	494	9194552	120,00	519
913043810	36,00	519	913463320KMB	23,00	494	92		
913049310	35,00	519	913463320LM	22,00	494	9262503	7,00	518
913214591	120,00	519	913463320LV	22,00	494	93		
9133317	7,00	519	913463320NM	23,00	494	95		
913331703	10,00	521	913463320OM	52,00	494	932010331	3,00	521
9133317031	4,00	521	913463320OP	52,00	494	96		
913400831	8,00	521	913463320OPM	52,00	494	953044052	7,00	521
9134008311	3,00	521	913463320OR	52,00	494	9530440521	2,00	521
9134011	45,00	477	913463330	12,00	494	953331550	8,00	521
913412380	31,00	371	9134665	7,00	518	9533315501	2,00	521
913414580	43,00	498	9134666	7,00	518	953331750	7,00	521
9134235	46,00	519	9134668	6,00	518	9533317501	2,00	521
9134250	13,00	520	9134672	6,00	518	9534294501	2,00	521
9134256	14,00	520	9134672501	13,00	518	96		
913427210	15,00	520	9134673	6,00	518	963033331	4,00	520
913427220	15,00	520	9134673501	13,00	518	966110301	9,00	520
913427510	25,00	520	9134674	6,00	518			
9134282	15,00	520	9134677	7,00	518			
9134283	7,00	520	9134681	8,00	518			
9134284	8,00	520	91346815	8,00	518			
9134286	8,00	520	91346816	6,00	518			
9134288	40,00	519	9134682	9,00	518			
9134290	40,00	519	91346825	8,00	518			
9134292	15,00	520	91346826	6,00	518			
9134293	15,00	520	9134683	11,00	519			
9134294	12,00	520	9134712	29,00	379			
9134296	17,00	520	9134725	12,00	375			
9134314	20,00	519	9134731	33,00	379			
9134315	25,00	519	9134731051	82,00	379			
9134316	30,00	519	913473810	36,00	370			
9134319	35,00	519	913474410	6,00	501			
9134415	45,00	400	913474420	6,00	501			
9134441	30,00	519	913474430	9,00	501			
9134450	20,00	376	9134745051	58,00	491			
9134481	70,00	519	9134746051	46,00	488			
9134515	60,00	399	9134779	10,00	502			
9134525	16,00	495	9134780	14,00	502			
9134525NM	25,00	495	9134781	6,00	501			
9134577	7,00	518	9134784	8,00	502			
			9134786	12,00	503			
			9134787	13,00	502			
			9134788	12,00	502			
			9134803	9,00	520			
			9134806	8,00	520			

Condiciones generales de venta

PRECIOS SIN IMPUESTOS (SIN IVA)

Precios

Los precios de esta tarifa, y cualquier anexo que publiquemos, deben considerarse "precios de venta recomendados para el cliente final antes de impuestos".

Los precios están sujetos a cualquier variación según las circunstancias del mercado, materias primas, mano de obra, impuestos... facturándose los que rijan el día de la expedición.

Pedidos

Se considerarán condicionales y sujetos, por lo tanto, a nuestra consideración.

Diseño

Nuestros modelos podrán ser modificados por exigencias de diseño, sin previo aviso, siempre en beneficio del artículo.

La documentación fotográfica y/o el diseño técnico reproducidos en los listados, catálogos, folletos y demás instrumentos publicitarios tienen valor indicativo, por lo que el cliente no podrá acogerse a ellos en caso de posibles quejas por disconformidad o diferencia con los productos suministrados. Las reclamaciones referentes a la falta de conformidad de los productos suministrados deberán realizarse, como máximo, en los quince días siguientes a la entrega de la mercancía en su lugar de destino.

Plazo de entrega

Nuestros plazos de entrega son siempre aproximados y no nos hacemos responsables de las consecuencias de cualquier retraso.

Expedición de productos

La mercancía viajará a portes pagados siempre que el pedido neto importe un mínimo de 150€. Si la compra es inferior a esta cantidad, viajará a portes pagados también pero realizaremos un cargo en la factura de 6€ en concepto de transporte y gestión. Para las islas, si el importe del pedido asciende a un mínimo de 600€, la mercancía viajará a portes pagados, si no, viajará siempre a portes debidos. Informamos que nuestro departamento de logística gestiona los pedidos de forma independiente y no acumula los mismos para alcanzar el importe mencionado.

El destinatario comprobará, al recibo de la mercancía, el estado de la misma, indicando en el albarán del transportista las posibles incidencias.

Garantía Tres

TRES COMERCIAL SL garantiza todos los productos comercializados bajo la marca TRES ante eventuales defectos estructurales, de material o de fabricación durante 3 años a partir de la fecha de compra por parte del consumidor final.

Adicionalmente, TRES COMERCIAL SL, ofrece una Garantía Comercial de 2 años adicionales (**Garantía de 5 años en total**), exceptuando:

- Revestimientos de acabados especiales (aquellos distintos del cromo).
- Grifería electrónica distinta del producto Shower Technology.
- Columnas de ducha, cartuchos temporizados.
- Complementos y accesorios (flexos, mandos de ducha, rociadores, soportes, llaves de paso, etc.)
- Materiales de consumo (filtros, juntas, aireadores, etc.)

Esta garantía no modifica los derechos que la legislación local otorga al consumidor final frente al comercializador del producto y frente al fabricante en el caso de haber sido adquirido en un distribuidor oficial.

Prerrequisitos de la Garantía

Para ejercer una reclamación de garantía es condición indispensable la presentación de una factura de compra donde se identifique claramente la fecha de compra y el distribuidor autorizado.

Para ejercer una reclamación de garantía el producto debe estar correctamente instalado, el uso debe haber sido de acuerdo con lo esperado para ese producto y la limpieza y mantenimiento debe haberse realizado de acuerdo a las indicaciones recogidas en el manual.

Servicios dentro del plazo de la Garantía

TRES COMERCIAL SL tiene la potestad de decidir la gestión a realizar, según la tipología del producto, entre la reparación por un Servicio Técnico Oficial, el suministro de un recambio para la reparación, la reparación en las instalaciones de TRES COMERCIAL SL o el cambio por un producto igual o similar en el caso de que el producto esté discontinuado.

Condiciones y exclusiones

TRES COMERCIAL SL se exime de toda responsabilidad:

- Si el producto no se ha instalado, mantenido y limpiado conforme a las instrucciones del mismo, incluidas en cada producto y disponibles en www.tresgriferia.com
- Si el producto no ha recibido el uso esperado para la tipología de producto.
- Si monta piezas no originales o evidencia signos de manipulación indebida.
- Si los defectos son resultado del transporte y/o la instalación.
- Si los elementos reclamados son aquellos sujetos a desgaste y éste es el normal para el uso dado.
- Si el defecto se produce por elementos externos agresivos (químicos, productos de limpieza corrosivos, instalación en ambientes agresivos, exceso de cal, hielo...)
- Si el defecto se produce por circunstancias ambientales (variaciones de presión, temperaturas extremas...)
- En caso de faltar un componente si éste no se ha reclamado en un plazo de 30 días desde la fecha de compra.

Límites de la Garantía

La eventual reparación, sustitución o cualquier prestación de servicio sobre el producto afectado, no extiende esta Garantía Comercial.

Para que esta Garantía sea válida, es necesario en cada caso, la aceptación del defecto por nuestro departamento técnico. En caso de que el producto analizado no presente ningún defecto cubierto por esta Garantía, se procederá a los siguientes cargos en concepto de Servicio Técnico:

- 12 € (IVA incluido) más gastos de transporte en el caso de análisis del defecto en las instalaciones de TRES COMERCIAL SL.
- Tarifa oficial del Servicio Técnico (a disposición de los clientes a través del dpto. Comercial) en caso de atención por parte del Servicio Técnico en la instalación.

La Garantía Comercial cubre únicamente la reparación o reposición del material sin cargo alguno para el cliente, y sin que en ningún caso podamos hacernos responsables de los daños y perjuicios que por su defecto haya podido producirse directa o indirectamente.

Pago

El importe de las facturas, salvo acuerdos especiales, será cancelado mediante giro SEPA B2B como máximo a 30 días fecha factura.

Reserva de dominio

TRES COMERCIAL SL será propietario de todos los productos suministrados al cliente, hasta el cobro completo de la factura correspondiente.

MUY IMPORTANTE

Devoluciones

TRES COMERCIAL SL no aceptará ninguna devolución de mercancía sin que previamente nuestro representante lo haya aceptado y comunicado.

- 1) TRES COMERCIAL SL no acepta ninguna devolución sin la aceptación previa (la mercancía se devolverá al remitente).
- 2) TRES COMERCIAL SL no acepta ninguna devolución de mercancía que pueda repararse con recambios originales.
- 3) TRES COMERCIAL SL no acepta ninguna devolución de mercancía fuera de garantía.
- 4) No obstante, en caso de recepcionar mercancía perfectamente encajada, esta sufrirá una depreciación en factura de:
 - Si es del año en curso: *-15% depreciación*
 - Si es anterior a dos años: *-30% depreciación*
 - Si es anterior a 3 años: *-60% depreciación*

Los envíos de mercaderías deberán efectuarse a portes pagados por el cliente.

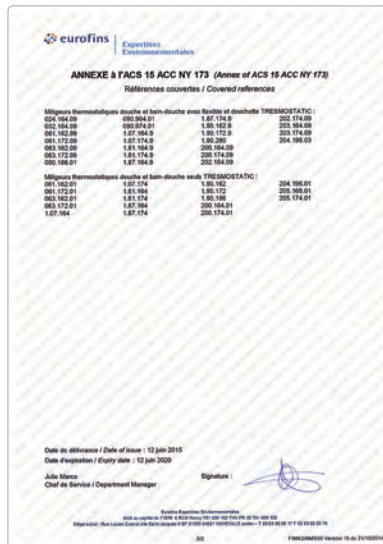



TRÈS

www.tresgriferia.com

C/ Penedès, 16-26 | Zona Industrial, Sector A | 08759 Vallirana (Barcelona)

España | comercial@tresgriferia.com | +34 93 683 40 27

Portugal | portugal@tresgriferia.com | +351 707 502 134

 sat@tresgriferia.com | +34 93 683 41 34

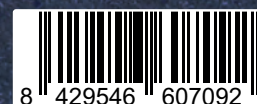

REF. 7342025010 / ED. 01-2025