

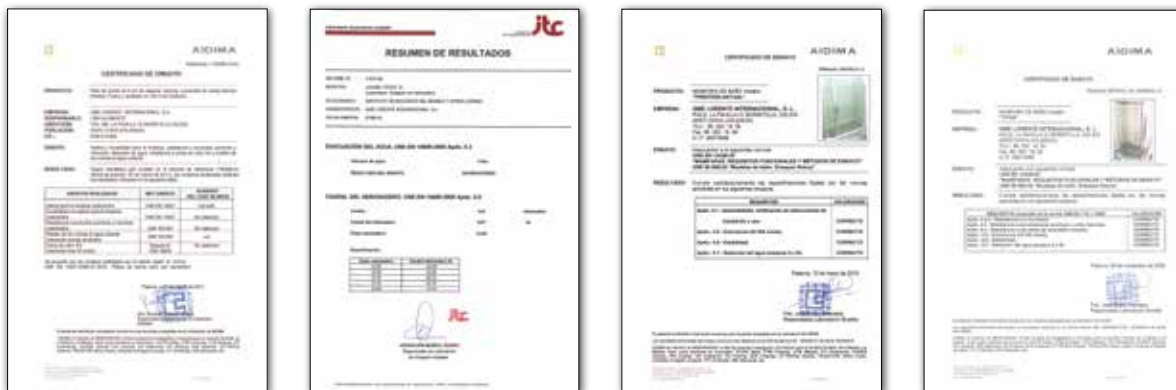

**MAMPARAS STD
Y A MEDIDA**
Servicio inmediato 100% Stock

**2025
COLORS**

CALIDAD CERTIFICADA



Preocupados por la calidad que ofrecemos a nuestros clientes, GME DIVISIÓN BAÑOS SL dispone de certificados que garantizan la calidad de todos sus productos, los cuales cumplen con todas las normativas europeas. **Nuestros acabados metálicos con tratamiento PVD son los mismos que nuestra grifería IO, pudiendo combinarlos a la perfección.**

Al mismo tiempo, GME DIVISIÓN BAÑOS SL está asociado al instituto tecnológico AIDIMME, en el cual, se realizan inspecciones y ensayos de laboratorio para garantizar la calidad y buen funcionamiento de los productos que les ofrecemos.

ASOCIADO N° 11666
AIDIMME
INSTITUTO TECNOLÓGICO



Los niveles de calidad de nuestras productos nos permiten ampliar a 3 años la garantía establecido por ley. Esta garantía no cubre elementos de plástico ó rodamientos y quedará anulada por el mal uso o mantenimiento de los productos.



PRESENCIA INTERNACIONAL

Malta	EE.UU.	España
Rumanía	Argelia	Portugal
Mauritania	Eslovenia	Andorra
Marruecos	Bélgica	Francia
Rep. Dominicana	Luxemburgo	Italia
Estonia	Suiza	Inglaterra
Lituania	Holanda	Grecia
Eslovaquia	Polonia	Alemania



Comprometidos con el **desarrollo sostenible** y el cuidado del medio ambiente, nos encontramos en proceso de implantación de la normativa **ISO 14001**, así como en proyectos de reducción de nuestra huella de carbono a través de la electrificación de nuestra maquinaria y vehículos, la obtención y utilización de recursos renovables y el reciclaje y reutilización de nuestras materias primas. Además, más del 75% de nuestros productos ya cuentan con un **embalaje ecológico** de cartón reciclado, reduciendo al máximo el uso de plásticos.



GME DIVISIÓN BAÑOS una de las 500 empresas líderes en Crecimiento Empresarial en 2023

CEPYME500 es una iniciativa de CEPYME con la que se quiere identificar, seleccionar y promocionar a un conjunto de 500 empresas que lideran el crecimiento empresarial, tanto por sus resultados como su capacidad para generar valor añadido, empleo, innovación y proyección internacional.

QUIÉNES SOMOS

GME DIVISIÓN BAÑOS S.L. es una empresa familiar valenciana que pertenece a LORENTE HOLDING VLC. Con más de 30 años de experiencia en la comercialización y distribución de productos orientados al acondicionamiento integral del baño. El grupo desarrolla dos líneas generales de negocio, una de ellas actúa como delegación de fabricantes de primer nivel, la otra, fabrica y comercializa productos bajo la marca GME.

Mediante el contacto permanente con nuestros clientes a través de nuestra amplia red comercial, desarrollamos las líneas de producto a comercializar que cubran las necesidades actuales del mercado, siempre tratando de mejorar la oferta existente a nivel de precio, calidad y servicio.



Nuestros 35000 m² de almacén nos permiten disponer de un amplio stock de todas las referencias de nuestro catálogo. Esto, unido al compromiso de preparar sus pedidos el mismo día de su recepción, hacen posible que los plazos de entrega, en condiciones normales, no supere las 72 horas.

Todo ello hace posible cumplir nuestro objetivo:
"La calidad sí tiene precio"



Fichas
Técnicas



Videos
Instalación



Inscripción
B2B



Listado Lotes
Referencias de lote
y su desglose por
componentes y unidades
(Ej. 5401 = 5001+5434)



Tarifa 2025
Referencia, descripción,
peso, volumen, PVP, código
arancelario, EAN.

7-31

33-57

CORREDERAS ALUMINIO



TWENTY ● ● ● ●

KENNA ● ● ●

59-97

99-115



BASIC ● ● ● ● ● ● ●

AKTUAL / PRESTIGE

117-139

141-159

ACERO



VETRUM / TEMPLE / FUTURA / MOVING

SCREEN ● ● ● ● ● ● ●

161-199



ABATIBLE OPEN ● ●

201-237



BISAGRA GLASS ● ● ● ● ● ● ● ●

239-253



PLEGABLES ● ●

255-263



+SOLUCIONES

265-287



BAÑERA ● ● ● ● ● ● ● ●

311-321





PLATOS DE DUCHA

twenty

20mm

“Tecnología y belleza con
sus tan solo 20mm de
perfilería y cierre Soft Close”

-  8-13 CROMO
-  14-19 NEGRO
-  20-25 ORO
-  26-31 COBRE

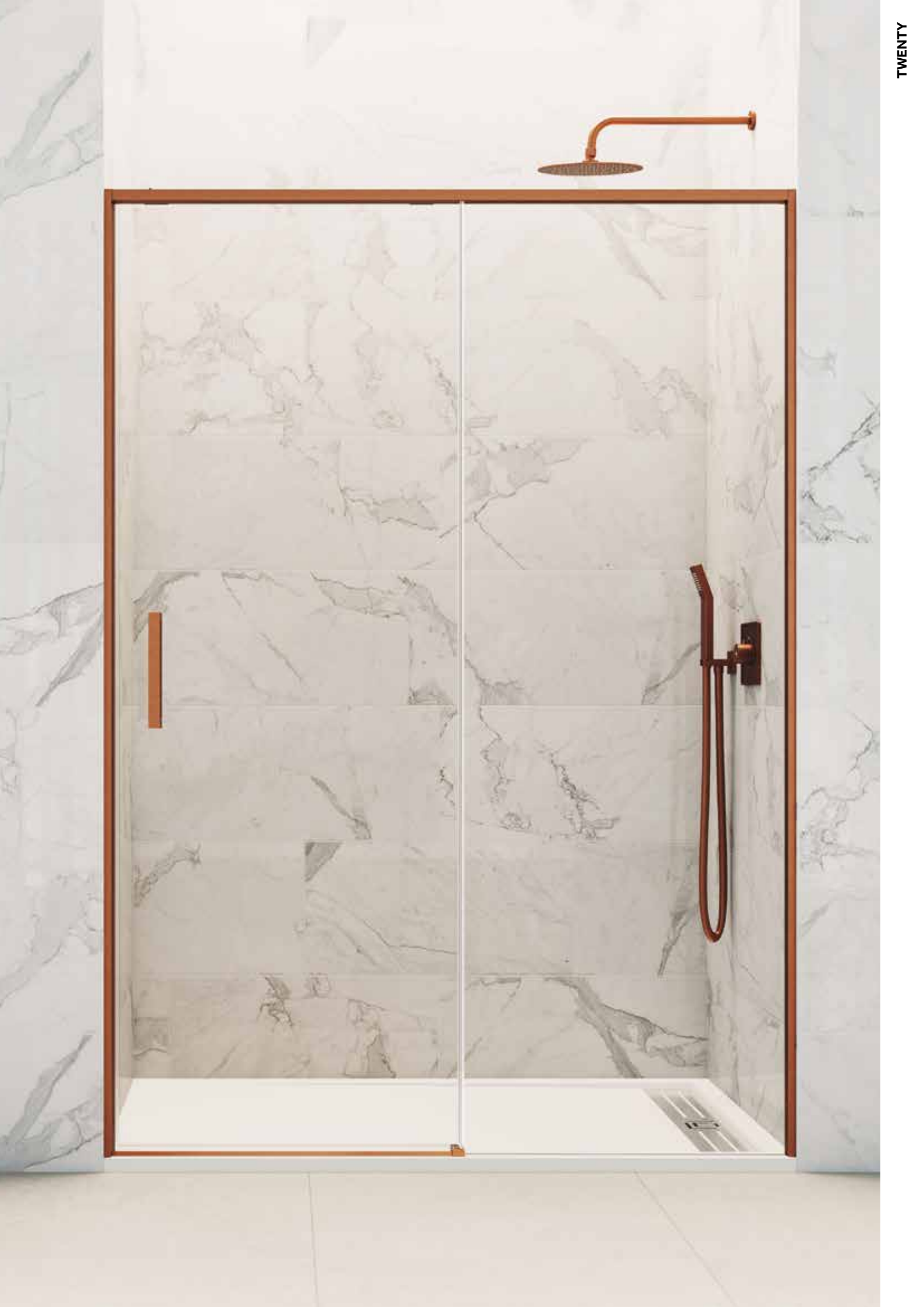

TWENTY 1 fijo+1 corredera



Cierre/apertura soft close



Rodamiento oculto



Guiador liberador de hoja



Opción tirador extraplano

Descripción	Rango	Apertura	Referencias	Puntos
Frontal ducha TWENTY 1F1C 115	110-115	43-48	1999+2021	373
Frontal ducha TWENTY 1F1C 120	115-120	46-51	2000+2021	377
Frontal ducha TWENTY 1F1C 125	120-125	49-54	2001+2021	381
Frontal ducha TWENTY 1F1C 130	125-130	51-56	2002+2021	385
Frontal ducha TWENTY 1F1C 135	130-135	54-59	2003+2021	389
Frontal ducha TWENTY 1F1C 140	135-140	56-61	2004+2021	393
Frontal ducha TWENTY 1F1C 145	140-145	59-64	2005+2021	397
Frontal ducha TWENTY 1F1C 150	145-150	61-66	2006+2021	401
Frontal ducha TWENTY 1F1C 155	150-155	64-69	2007+2022	422
Frontal ducha TWENTY 1F1C 160	155-160	66-71	2008+2022	426
Frontal ducha TWENTY 1F1C 165	160-165	69-74	2009+2022	430
Frontal ducha TWENTY 1F1C 170	165-170	71-76	2010+2022	433
Frontal ducha TWENTY 1F1C 175	170-175	74-79	2011+2022	438
Frontal ducha TWENTY 1F1C 180	175-180	76-81	2012+2022	442

*Desglose por referencias/punto en página 306

TWENTY 2 fijos+2 correderas

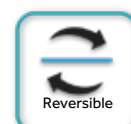
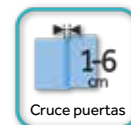

Descripción	Rango	Apertura	Referencias	Puntos
Frontal ducha TWENTY 2F2C 140 (75+75)	131-141	44-54	2031+2031+2042	550
Frontal ducha TWENTY 2F2C 150 (80+80)	141-151	49-59	2032+2032+2042	558
Frontal ducha TWENTY 2F2C 160 (85+85)	151-161	54-64	2033+2033+2042	568
Frontal ducha TWENTY 2F2C 170 (90+90)	161-171	59-69	2034+2034+2042	578
Frontal ducha TWENTY 2F2C 180 (95+95)	171-181	64-74	2035+2035+2042	586
Frontal ducha TWENTY 2F2C 190 (100+100)	181-191	69-79	2036+2036+2042	594
Opción tirador extraplano largo 39,5x1,4x1,6cm			2052	45

*Admite lateral fijo en ambos lados, consultar página 12



	TRANSPARENTE	FROST PLUS PARSOL / MATE	CAJONADO
Mamparas a medida y cristales especiales	+45%	+60%	+21

*Plazo de entrega 15 días (más información en pág. 288)

TWENTY angular al vértice



Mamparas a medida y cristales especiales

TRANSPARENTE

+45%

FROST PLUS
PARSOL / MATE

+60%

CAJONADO

+21

*Plazo de entrega 15 días (más información en pág. 288)

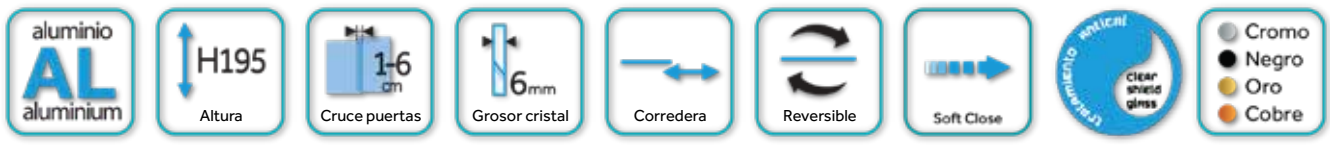

combinaciones **TWENTY** al vértice

Medida	Rangos	Apertura	Referencias	Puntos
70X70	65-70/65-70	30-35	2030+2030+2038	549
75X70	70-75/65-70	32-37	2031+2030+2038	554
80X70	75-80/65-70	34-39	2032+2030+2038	558
85X70	80-85/65-70	36-41	2033+2030+2038	563
90X70	85-90/65-70	38-43	2034+2030+2038	568
95X70	90-95/65-70	40-45	2035+2030+2038	572
100X70	95-100/65-70	42-47	2036+2030+2038	576
120X70	115-120/65-70	52-57	2037+2030+2038	595
Medida	Rangos	Apertura	Referencias	Puntos
75X75	70-75/70-75	34-39	2031+2031+2038	559
80X75	75-80/70-75	36-41	2032+2031+2038	563
85X75	80-85/70-75	38-43	2033+2031+2038	568
90X75	85-90/70-75	40-45	2034+2031+2038	573
95X75	90-95/70-75	42-47	2035+2031+2038	577
100X75	95-100/70-75	45-50	2036+2031+2038	581
120X75	115-120/70-75	54-59	2037+2031+2038	600
Medida	Rangos	Apertura	Referencias	Puntos
80X80	75-80/75-80	38-43	2032+2032+2038	567
85X80	80-85/75-80	40-45	2033+2032+2038	572
90X80	85-90/75-80	42-47	2034+2032+2038	577
95X80	90-95/75-80	45-50	2035+2032+2038	581
100X80	95-100/75-80	47-52	2036+2032+2038	585
120X80	115-120/75-80	56-61	2037+2032+2038	604
Medida	Rangos	Apertura	Referencias	Puntos
90X90	85-90/85-90	47-52	2034+2034+2038	587
95X90	90-95/85-90	49-54	2035+2034+2038	591
100X90	95-100/85-90	50-55	2036+2034+2038	595
120X90	115-120/85-90	60-65	2037+2034+2038	614

*Desglose por referencias/punto en página 306



Innovador sistema antivuelco



Rodamiento oculto



Doble asa metálica



Apertura soft close

TWENTY frontal + lateral fijo de 6 mm



Descripción	Rango	Ref.	Puntos
Lateral fijo TWENTY 70	66,5-69,5	2013	173
Lateral fijo TWENTY 75	71,5-74,5	2014	180
Lateral fijo TWENTY 80	76,5-79,5	2015	188
Lateral fijo TWENTY 90	86,5-89,5	2016	203

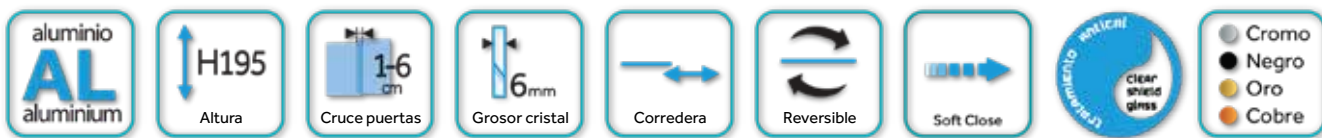

combinaciones frontales **TWENTY** + lateral fijo de 6 mm

Medida	Rangos	Referencias	Puntos	Medida	Rangos	Referencias	Puntos
115x70	110-115/66,5-69,5	1999+2021+2013	546	115x75	110-115/71,5-74,5	1999+2021+2014	553
120x70	115-120/66,5-69,5	2000+2021+2013	550	120x75	115-120/71,5-74,5	2000+2021+2014	557
125x70	120-125/66,5-69,5	2001+2021+2013	554	125x75	120-125/71,5-74,5	2001+2021+2014	561
130x70	125-130/66,5-69,5	2002+2021+2013	558	130x75	125-130/71,5-74,5	2002+2021+2014	565
135x70	130-135/66,5-69,5	2003+2021+2013	562	135x75	130-135/71,5-74,5	2003+2021+2014	569
140x70	135-140/66,5-69,5	2004+2021+2013	566	140x75	135-140/71,5-74,5	2004+2021+2014	573
145x70	140-145/66,5-69,5	2005+2021+2013	570	145x75	140-145/71,5-74,5	2005+2021+2014	577
150x70	145-150/66,5-69,5	2006+2021+2013	574	150x75	145-150/71,5-74,5	2006+2021+2014	581
155x70	150-155/66,5-69,5	2007+2022+2013	595	155x75	150-155/71,5-74,5	2007+2022+2014	602
160x70	155-160/66,5-69,5	2008+2022+2013	599	160x75	155-160/71,5-74,5	2008+2022+2014	606
165x70	160-165/66,5-69,5	2009+2022+2013	603	165x75	160-165/71,5-74,5	2009+2022+2014	610
170x70	165-170/66,5-69,5	2010+2022+2013	606	170x75	165-170/71,5-74,5	2010+2022+2014	613
175x70	170-175/66,5-69,5	2011+2022+2013	611	175x75	170-175/71,5-74,5	2011+2022+2014	618
180x70	175-180/66,5-69,5	2012+2022+2013	615	180x75	175-180/71,5-74,5	2012+2022+2014	622
Medida	Rangos	Referencias	Puntos	Medida	Rangos	Referencias	Puntos
115x80	110-115/76,5-79,5	1999+2021+2015	561	115x90	110-115/86,5-89,5	1999+2021+2016	576
120x80	115-120/76,5-79,5	2000+2021+2015	565	120x90	115-120/86,5-89,5	2000+2021+2016	580
125x80	120-125/76,5-79,5	2001+2021+2015	569	125x90	120-125/86,5-89,5	2001+2021+2016	584
130x80	125-130/76,5-79,5	2002+2021+2015	573	130x90	125-130/86,5-89,5	2002+2021+2016	588
135x80	130-135/76,5-79,5	2003+2021+2015	577	135x90	130-135/86,5-89,5	2003+2021+2016	592
140x80	135-140/76,5-79,5	2004+2021+2015	581	140x90	135-140/86,5-89,5	2004+2021+2016	596
145x80	140-145/76,5-79,5	2005+2021+2015	585	145x90	140-145/86,5-89,5	2005+2021+2016	600
150x80	145-150/76,5-79,5	2006+2021+2015	589	150x90	145-150/86,5-89,5	2006+2021+2016	604
155x80	150-155/76,5-79,5	2007+2022+2015	610	155x90	150-155/86,5-89,5	2007+2022+2016	625
160x80	155-160/76,5-79,5	2008+2022+2015	614	160x90	155-160/86,5-89,5	2008+2022+2016	629
165x80	160-165/76,5-79,5	2009+2022+2015	618	165x90	160-165/86,5-89,5	2009+2022+2016	633
170x80	165-170/76,5-79,5	2010+2022+2015	621	170x90	165-170/86,5-89,5	2010+2022+2016	636
175x80	170-175/76,5-79,5	2011+2022+2015	626	175x90	170-175/86,5-89,5	2011+2022+2016	641
180x80	175-180/76,5-79,5	2012+2022+2015	630	180x90	175-180/86,5-89,5	2012+2022+2016	645

Las aperturas son las mismas que en los frontales. Admite lateral fijo en ambos lados.



Laterales fijos a medida (más información en página 291)

Descripción	Referencias	Puntos	Cajonado
Lateral fijo a medida TWENTY hasta 40 cm	1375	212	+21
Lateral fijo a medida TWENTY de 40 hasta 80 cm	1376	291	+21
Lateral fijo a medida TWENTY de 80 hasta 120 cm	1377	361	+21

*Plazo de entrega 15 días

TWENTY NEGRA 1 fijo+1 corredera



Cierre/apertura soft close



Rodamiento oculto



Opción tirador extraplano



*Juego 2 gomas verticales negras ref. 0014, 15 puntos

Descripción	Rango	Apertura	Ref.	Puntos
Frontal ducha TWENTY 1F1C NEGRA 115	110-115	43-48	1999+2023	384
Frontal ducha TWENTY 1F1C NEGRA 120	115-120	46-51	2000+2023	388
Frontal ducha TWENTY 1F1C NEGRA 125	120-125	49-54	2001+2023	392
Frontal ducha TWENTY 1F1C NEGRA 130	125-130	51-56	2002+2023	396
Frontal ducha TWENTY 1F1C NEGRA 135	130-135	54-59	2003+2023	400
Frontal ducha TWENTY 1F1C NEGRA 140	135-140	56-61	2004+2023	404
Frontal ducha TWENTY 1F1C NEGRA 145	140-145	59-64	2005+2023	408
Frontal ducha TWENTY 1F1C NEGRA 150	145-150	61-66	2006+2023	412
Frontal ducha TWENTY 1F1C NEGRA 155	150-155	64-69	2007+2024	438
Frontal ducha TWENTY 1F1C NEGRA 160	155-160	66-71	2008+2024	442
Frontal ducha TWENTY 1F1C NEGRA 165	160-165	69-74	2009+2024	446
Frontal ducha TWENTY 1F1C NEGRA 170	165-170	71-76	2010+2024	449
Frontal ducha TWENTY 1F1C NEGRA 175	170-175	74-79	2011+2024	454
Frontal ducha TWENTY 1F1C NEGRA 180	175-180	76-81	2012+2024	458

*Desglose por referencias/punto en página 306

TWENTY NEGRA 2 fijos+2 correderas



Descripción	Rango	Apertura	Ref.	Puntos
Frontal ducha TWENTY 2F2C NEGRA 140 (75+75)	131-141	44-54	2031+2031+2043	564
Frontal ducha TWENTY 2F2C NEGRA 150 (80+80)	141-151	49-59	2032+2032+2043	572
Frontal ducha TWENTY 2F2C NEGRA 160 (85+85)	151-161	54-64	2033+2033+2043	582
Frontal ducha TWENTY 2F2C NEGRA 170 (90+90)	161-171	59-69	2034+2034+2043	592
Frontal ducha TWENTY 2F2C NEGRA 180 (95+95)	171-181	64-74	2035+2035+2043	600
Frontal ducha TWENTY 2F2C NEGRA 190 (100+100)	181-191	69-79	2036+2036+2043	608
Opción tirador extraplano largo 39,5x1,4x1,6cm			2052N	47

*Admite lateral fijo en ambos lados, consultar página 20



	TRANSPARENTE	FROST PLUS PARSOL / MATE	CAJONADO
Mamparas a medida y cristales especiales	+45%	+60%	+21

*Plazo de entrega 15 días (más información en pág. 288)

TWENTY NEGRA angular al vértice



Mamparas a medida y cristales especiales

TRANSPARENTE

+45%

FROST PLUS
PARSOL / MATE

+60%

CAJONADO

+21

*Plazo de entrega 15 días (más información en pág. 288)

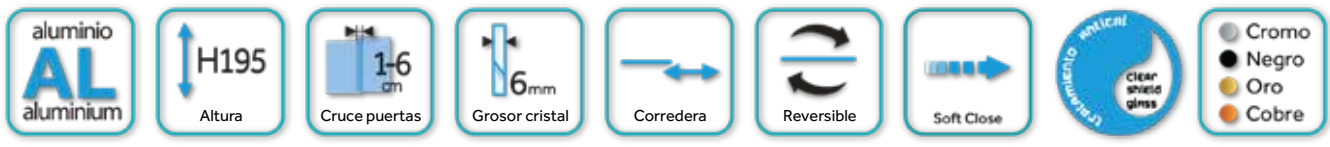

combinaciones **TWENTY NEGRA** al vértice

Medida	Rangos	Apertura	Referencias	Puntos
70X70	65-70/65-70	30-35	2030+2030+2039	563
75X70	70-75/65-70	32-37	2031+2030+2039	568
80X70	75-80/65-70	34-39	2032+2030+2039	572
85X70	80-85/65-70	36-41	2033+2030+2039	577
90X70	85-90/65-70	38-43	2034+2030+2039	582
95X70	90-95/65-70	40-45	2035+2030+2039	586
100X70	95-100/65-70	42-47	2036+2030+2039	590
120X70	115-120/65-70	52-57	2037+2030+2039	609
Medida	Rangos	Apertura	Referencias	Puntos
75X75	70-75/70-75	34-39	2031+2031+2039	573
80X75	75-80/70-75	36-41	2032+2031+2039	577
85X75	80-85/70-75	38-43	2033+2031+2039	582
90X75	85-90/70-75	40-45	2034+2031+2039	587
95X75	90-95/70-75	42-47	2035+2031+2039	591
100X75	95-100/70-75	45-50	2036+2031+2039	595
120X75	115-120/70-75	54-59	2037+2031+2039	614
Medida	Rangos	Apertura	Referencias	Puntos
80X80	75-80/75-80	38-43	2032+2032+2039	581
85X80	80-85/75-80	40-45	2033+2032+2039	586
90X80	85-90/75-80	42-47	2034+2032+2039	591
95X80	90-95/75-80	45-50	2035+2032+2039	595
100X80	95-100/75-80	47-52	2036+2032+2039	599
120X80	115-120/75-80	56-61	2037+2032+2039	618
Medida	Rangos	Apertura	Referencias	Puntos
90X90	85-90/85-90	47-52	2034+2034+2039	601
95X90	90-95/85-90	49-54	2035+2034+2039	605
100X90	95-100/85-90	50-55	2036+2034+2039	609
120X90	115-120/85-90	60-65	2037+2034+2039	628

*Desglose por referencias/punto en página 306



Innovador sistema antivuelco



Rodamiento oculto



Apertura soft close



*Juego 2 gomas verticales negras ref. 0014, 15 puntos

TWENTY NEGRA frontal + lateral fijo 6mm



Descripción	Rango	Ref.	Puntos
Lateral fijo TWENTY NEGRA 70	66,5-69,5	2017	178
Lateral fijo TWENTY NEGRA 75	71,5-74,5	2018	188
Lateral fijo TWENTY NEGRA 80	76,5-79,5	2019	198
Lateral fijo TWENTY NEGRA 90	86,5-89,5	2020	213



Laterales fijos a medida (más información en página 291)

Descripción	Referencias	Puntos	Cajonado
Lateral fijo a medida TWENTY hasta 40 cm	1375N	217	+21
Lateral fijo a medida TWENTY de 40 hasta 80 cm	1376N	296	+21
Lateral fijo a medida TWENTY de 80 hasta 120 cm	1377N	366	+21

*Plazo de entrega 15 días

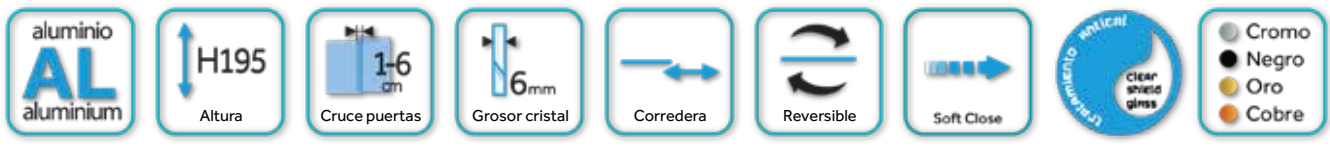

combinaciones frontales **TWENTY NEGRA** + lateral fijo de 6 mm

Medida	Rangos	Referencias	Puntos
115x70	110-115/66,5-69,5	1999+2023+2017	562
120x70	115-120/66,5-69,5	2000+2023+2017	566
125x70	120-125/66,5-69,5	2001+2023+2017	570
130x70	125-130/66,5-69,5	2002+2023+2017	574
135x70	130-135/66,5-69,5	2003+2023+2017	578
140x70	135-140/66,5-69,5	2004+2023+2017	582
145x70	140-145/66,5-69,5	2005+2023+2017	586
150x70	145-150/66,5-69,5	2006+2023+2017	590
155x70	150-155/66,5-69,5	2007+2024+2017	616
160x70	155-160/66,5-69,5	2008+2024+2017	620
165x70	160-165/66,5-69,5	2009+2024+2017	624
170x70	165-170/66,5-69,5	2010+2024+2017	627
175x70	170-175/66,5-69,5	2011+2024+2017	632
180x70	175-180/66,5-69,5	2012+2024+2017	636
Medida	Rangos	Referencias	Puntos
115x80	110-115/76,5-79,5	1999+2023+2019	582
120x80	115-120/76,5-79,5	2000+2023+2019	586
125x80	120-125/76,5-79,5	2001+2023+2019	590
130x80	125-130/76,5-79,5	2002+2023+2019	594
135x80	130-135/76,5-79,5	2003+2023+2019	598
140x80	135-140/76,5-79,5	2004+2023+2019	602
145x80	140-145/76,5-79,5	2005+2023+2019	606
150x80	145-150/76,5-79,5	2006+2023+2019	610
155x80	150-155/76,5-79,5	2007+2024+2019	636
160x80	155-160/76,5-79,5	2008+2024+2019	640
165x80	160-165/76,5-79,5	2009+2024+2019	644
170x80	165-170/76,5-79,5	2010+2024+2019	647
175x80	170-175/76,5-79,5	2011+2024+2019	652
180x80	175-180/76,5-79,5	2012+2024+2019	656

Medida	Rangos	Referencias	Puntos
115x75	110-115/71,5-74,5	1999+2023+2018	572
120x75	115-120/71,5-74,5	2000+2023+2018	576
125x75	120-125/71,5-74,5	2001+2023+2018	580
130x75	125-130/71,5-74,5	2002+2023+2018	584
135x75	130-135/71,5-74,5	2003+2023+2018	588
140x75	135-140/71,5-74,5	2004+2023+2018	592
145x75	140-145/71,5-74,5	2005+2023+2018	596
150x75	145-150/71,5-74,5	2006+2023+2018	600
155x75	150-155/71,5-74,5	2007+2024+2018	626
160x75	155-160/71,5-74,5	2008+2024+2018	630
165x75	160-165/71,5-74,5	2009+2024+2018	634
170x75	165-170/71,5-74,5	2010+2024+2018	637
175x75	170-175/71,5-74,5	2011+2024+2018	642
180x75	175-180/71,5-74,5	2012+2024+2018	646
Medida	Rangos	Referencias	Puntos
115x90	110-115/86,5-89,5	1999+2023+2020	597
120x90	115-120/86,5-89,5	2000+2023+2020	601
125x90	120-125/86,5-89,5	2001+2023+2020	605
130x90	125-130/86,5-89,5	2002+2023+2020	609
135x90	130-135/86,5-89,5	2003+2023+2020	613
140x90	135-140/86,5-89,5	2004+2023+2020	617
145x90	140-145/86,5-89,5	2005+2023+2020	621
150x90	145-150/86,5-89,5	2006+2023+2020	625
155x90	150-155/86,5-89,5	2007+2024+2020	651
160x90	155-160/86,5-89,5	2008+2024+2020	655
165x90	160-165/86,5-89,5	2009+2024+2020	659
170x90	165-170/86,5-89,5	2010+2024+2020	662
175x90	170-175/86,5-89,5	2011+2024+2020	667
180x90	175-180/86,5-89,5	2012+2024+2020	671

Las aperturas son las mismas que en los frontales. Admite lateral fijo en ambos lados.



Guiador liberador de hoja



Rodamiento oculto



Cierre/apertura soft close



*Juego 2 gomas verticales negras ref. 0014, 15 puntos

TWENTY ORO 1 fijo+1 corredera



Cierre/apertura soft close



Rodamiento oculto



Guiador liberador de hoja



Opción tirador extraplano

Descripción	Rango	Apertura	Ref.	Puntos
Frontal ducha TWENTY 1F1C ORO 115	110-115	43-48	1999+2044	417
Frontal ducha TWENTY 1F1C ORO 120	115-120	46-51	2000+2044	421
Frontal ducha TWENTY 1F1C ORO 125	120-125	49-54	2001+2044	425
Frontal ducha TWENTY 1F1C ORO 130	125-130	51-56	2002+2044	429
Frontal ducha TWENTY 1F1C ORO 135	130-135	54-59	2003+2044	433
Frontal ducha TWENTY 1F1C ORO 140	135-140	56-61	2004+2044	437
Frontal ducha TWENTY 1F1C ORO 145	140-145	59-64	2005+2044	441
Frontal ducha TWENTY 1F1C ORO 150	145-150	61-66	2006+2044	445
Frontal ducha TWENTY 1F1C ORO 155	150-155	64-69	2007+2045	473
Frontal ducha TWENTY 1F1C ORO 160	155-160	66-71	2008+2045	477
Frontal ducha TWENTY 1F1C ORO 165	160-165	69-74	2009+2045	481
Frontal ducha TWENTY 1F1C ORO 170	165-170	71-76	2010+2045	484
Frontal ducha TWENTY 1F1C ORO 175	170-175	74-79	2011+2045	489
Frontal ducha TWENTY 1F1C ORO 180	175-180	76-81	2012+2045	493

*Desglose por referencias/punto en página 306

TWENTY ORO 2 fijos+2 correderas

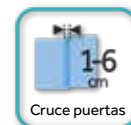

Descripción	Rango	Apertura	Ref.	Puntos
Frontal ducha TWENTY 2F2C ORO 140 (75+75)	131-141	44-54	2031+2031+2047	601
Frontal ducha TWENTY 2F2C ORO 150 (80+80)	141-151	49-59	2032+2032+2047	609
Frontal ducha TWENTY 2F2C ORO 160 (85+85)	151-161	54-64	2033+2033+2047	619
Frontal ducha TWENTY 2F2C ORO 170 (90+90)	161-171	59-69	2034+2034+2047	629
Frontal ducha TWENTY 2F2C ORO 180 (95+95)	171-181	64-74	2035+2035+2047	637
Frontal ducha TWENTY 2F2C ORO 190 (100+100)	181-191	69-79	2036+2036+2047	645
Opción tirador extraplano largo 39,5x1,4x1,6cm			2052OR	50

*Admite lateral fijo en ambos lados, consultar página 24.



	TRANSPARENTE	FROST PLUS PARSOL / MATE	CAJONADO
Mamparas a medida y cristales especiales	+45%	+60%	+21

*Plazo de entrega 15 días (más información en pág. 288)

TWENTY ORO angular al vértice

Oro cepillado



	TRANSPARENTE	FROST PLUS PARSOL / MATE	CAJONADO
Mamparas a medida y cristales especiales	+45%	+60%	+21

*Plazo de entrega 15 días (más información en pág. 288)

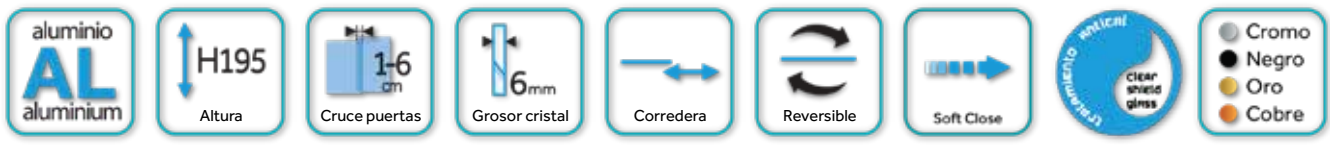

combinaciones **TWENTY ORO** al vértice

Medida	Rangos	Apertura	Referencias	Puntos
70X70	65-70/65-70	30-35	2030+2030+2046	600
75X70	70-75/65-70	32-37	2031+2030+2046	605
80X70	75-80/65-70	34-39	2032+2030+2046	609
85X70	80-85/65-70	36-41	2033+2030+2046	614
90X70	85-90/65-70	38-43	2034+2030+2046	619
95X70	90-95/65-70	40-45	2035+2030+2046	623
100X70	95-100/65-70	42-47	2036+2030+2046	627
120X70	115-120/65-70	52-57	2037+2030+2046	646
Medida	Rangos	Apertura	Referencias	Puntos
75X75	70-75/70-75	34-39	2031+2031+2046	610
80X75	75-80/70-75	36-41	2032+2031+2046	614
85X75	80-85/70-75	38-43	2033+2031+2046	619
90X75	85-90/70-75	40-45	2034+2031+2046	624
95X75	90-95/70-75	42-47	2035+2031+2046	628
100X75	95-100/70-75	45-50	2036+2031+2046	632
120X75	115-120/70-75	54-59	2037+2031+2046	651
Medida	Rangos	Apertura	Referencias	Puntos
80X80	75-80/75-80	38-43	2032+2032+2046	618
85X80	80-85/75-80	40-45	2033+2032+2046	623
90X80	85-90/75-80	42-47	2034+2032+2046	628
95X80	90-95/75-80	45-50	2035+2032+2046	632
100X80	95-100/75-80	47-52	2036+2032+2046	636
120X80	115-120/75-80	56-61	2037+2032+2046	655
Medida	Rangos	Apertura	Referencias	Puntos
90X90	85-90/85-90	47-52	2034+2034+2046	638
95X90	90-95/85-90	49-54	2035+2034+2046	642
100X90	95-100/85-90	50-55	2036+2034+2046	646
120X90	115-120/85-90	60-65	2037+2034+2046	665

*Desglose por referencias/punto en página 306

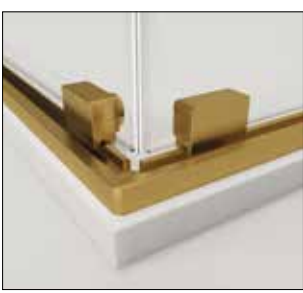

Innovador sistema antivuelco



Rodamiento oculto



Doble asa metálica



Apertura soft close

TWENTY ORO frontal + lateral fijo 6mm

Oro cepillado



Descripción	Rango	Ref.	Puntos
Lateral fijo TWENTY ORO 70	66,5-69,5	2048	200
Lateral fijo TWENTY ORO 75	71,5-74,5	2049	208
Lateral fijo TWENTY ORO 80	76,5-79,5	2050	217
Lateral fijo TWENTY ORO 90	86,5-89,5	2051	234



Laterales fijos a medida (más información en página 291)

Descripción	Referencias	Puntos	Cajonado
Lateral fijo a medida TWENTY hasta 40 cm	1375OR	227	+21
Lateral fijo a medida TWENTY de 40 hasta 80 cm	1376OR	306	+21
Lateral fijo a medida TWENTY de 80 hasta 120 cm	1377OR	376	+21

*Plazo de entrega 15 días

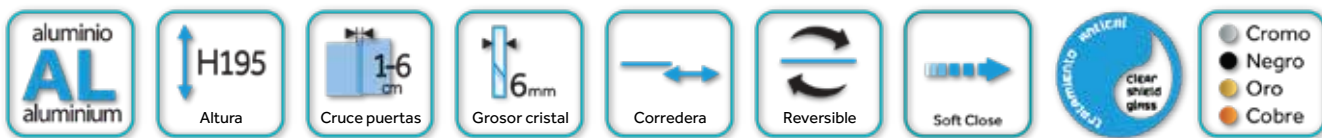

combinaciones frontales **TWENTY ORO** + lateral fijo de 6 mm

Medida	Rangos	Referencias	Puntos	Medida	Rangos	Referencias	Puntos
115x70	110-115/66,5-69,5	1999+2044+2048	617	115x75	110-115/71,5-74,5	1999+2044+2049	625
120x70	115-120/66,5-69,5	2000+2044+2048	621	120x75	115-120/71,5-74,5	2000+2044+2049	629
125x70	120-125/66,5-69,5	2001+2044+2048	625	125x75	120-125/71,5-74,5	2001+2044+2049	633
130x70	125-130/66,5-69,5	2002+2044+2048	629	130x75	125-130/71,5-74,5	2002+2044+2049	637
135x70	130-135/66,5-69,5	2003+2044+2048	633	135x75	130-135/71,5-74,5	2003+2044+2049	641
140x70	135-140/66,5-69,5	2004+2044+2048	637	140x75	135-140/71,5-74,5	2004+2044+2049	645
145x70	140-145/66,5-69,5	2005+2044+2048	641	145x75	140-145/71,5-74,5	2005+2044+2049	649
150x70	145-150/66,5-69,5	2006+2044+2048	645	150x75	145-150/71,5-74,5	2006+2044+2049	653
155x70	150-155/66,5-69,5	2007+2045+2048	673	155x75	150-155/71,5-74,5	2007+2045+2049	681
160x70	155-160/66,5-69,5	2008+2045+2048	677	160x75	155-160/71,5-74,5	2008+2045+2049	685
165x70	160-165/66,5-69,5	2009+2045+2048	681	165x75	160-165/71,5-74,5	2009+2045+2049	689
170x70	165-170/66,5-69,5	2010+2045+2048	684	170x75	165-170/71,5-74,5	2010+2045+2049	692
175x70	170-175/66,5-69,5	2011+2045+2048	689	175x75	170-175/71,5-74,5	2011+2045+2049	697
180x70	175-180/66,5-69,5	2012+2045+2048	693	180x75	175-180/71,5-74,5	2012+2045+2049	701
Medida	Rangos	Referencias	Puntos	Medida	Rangos	Referencias	Puntos
115x80	110-115/76,5-79,5	1999+2044+2050	634	115x90	110-115/86,5-89,5	1999+2044+2051	651
120x80	115-120/76,5-79,5	2000+2044+2050	638	120x90	115-120/86,5-89,5	2000+2044+2051	655
125x80	120-125/76,5-79,5	2001+2044+2050	642	125x90	120-125/86,5-89,5	2001+2044+2051	659
130x80	125-130/76,5-79,5	2002+2044+2050	646	130x90	125-130/86,5-89,5	2002+2044+2051	663
135x80	130-135/76,5-79,5	2003+2044+2050	650	135x90	130-135/86,5-89,5	2003+2044+2051	667
140x80	135-140/76,5-79,5	2004+2044+2050	654	140x90	135-140/86,5-89,5	2004+2044+2051	671
145x80	140-145/76,5-79,5	2005+2044+2050	658	145x90	140-145/86,5-89,5	2005+2044+2051	675
150x80	145-150/76,5-79,5	2006+2044+2050	662	150x90	145-150/86,5-89,5	2006+2044+2051	679
155x80	150-155/76,5-79,5	2007+2045+2050	690	155x90	150-155/86,5-89,5	2007+2045+2051	707
160x80	155-160/76,5-79,5	2008+2045+2050	694	160x90	155-160/86,5-89,5	2008+2045+2051	711
165x80	160-165/76,5-79,5	2009+2045+2050	698	165x90	160-165/86,5-89,5	2009+2045+2051	715
170x80	165-170/76,5-79,5	2010+2045+2050	701	170x90	165-170/86,5-89,5	2010+2045+2051	718
175x80	170-175/76,5-79,5	2011+2045+2050	706	175x90	170-175/86,5-89,5	2011+2045+2051	723
180x80	175-180/76,5-79,5	2012+2045+2050	710	180x90	175-180/86,5-89,5	2012+2045+2051	727

Las aperturas son las mismas que en los frontales. Admite lateral fijo en ambos lados.



Guiador liberador de hoja



Rodamiento oculto



Doble asa metálica



Cierre/apertura soft close

TWENTY COBRE 1 fijo+1 corredera



Cierre/apertura soft close



Rodamiento oculto



Guiador liberador de hoja



Opción tirador extraplano

Descripción	Rango	Apertura	Ref.	Puntos
Frontal ducha TWENTY 1F1C COBRE 115	110-115	43-48	1999+2060	417
Frontal ducha TWENTY 1F1C COBRE 120	115-120	46-51	2000+2060	421
Frontal ducha TWENTY 1F1C COBRE 125	120-125	49-54	2001+2060	425
Frontal ducha TWENTY 1F1C COBRE 130	125-130	51-56	2002+2060	429
Frontal ducha TWENTY 1F1C COBRE 135	130-135	54-59	2003+2060	433
Frontal ducha TWENTY 1F1C COBRE 140	135-140	56-61	2004+2060	437
Frontal ducha TWENTY 1F1C COBRE 145	140-145	59-64	2005+2060	441
Frontal ducha TWENTY 1F1C COBRE 150	145-150	61-66	2006+2060	445
Frontal ducha TWENTY 1F1C COBRE 155	150-155	64-69	2007+2061	473
Frontal ducha TWENTY 1F1C COBRE 160	155-160	66-71	2008+2061	477
Frontal ducha TWENTY 1F1C COBRE 165	160-165	69-74	2009+2061	481
Frontal ducha TWENTY 1F1C COBRE 170	165-170	71-76	2010+2061	484
Frontal ducha TWENTY 1F1C COBRE 175	170-175	74-79	2011+2061	489
Frontal ducha TWENTY 1F1C COBRE 180	175-180	76-81	2012+2061	493

*Desglose por referencias/punto en página 306

TWENTY COBRE 2 fijos+2 correderas



Descripción	Rango	Apertura	Ref.	Puntos
Frontal ducha TWENTY 2F2C COBRE 140 (75+75)	131-141	44-54	2031+2031+2063	601
Frontal ducha TWENTY 2F2C COBRE 150 (80+80)	141-151	49-59	2032+2032+2063	609
Frontal ducha TWENTY 2F2C COBRE 160 (85+85)	151-161	54-64	2033+2033+2063	619
Frontal ducha TWENTY 2F2C COBRE 170 (90+90)	161-171	59-69	2034+2034+2063	629
Frontal ducha TWENTY 2F2C COBRE 180 (95+95)	171-181	64-74	2035+2035+2063	637
Frontal ducha TWENTY 2F2C COBRE 190 (100+100)	181-191	69-79	2036+2036+2063	645
Opción tirador extraplano largo 39,5x1,4x1,6cm			2052CB	50

*Admite lateral fijo en ambos lados, consultar página 30.



	TRANSPARENTE	FROST PLUS PARSOL / MATE	CAJONADO
Mamparas a medida y cristales especiales	+45%	+60%	+21

*Plazo de entrega 15 días (más información en pág. 288)

TWENTY COBRE angular al vértice



Mamparas a medida y cristales especiales

TRANSPARENTE

+45%

FROST PLUS
PARSOL / MATE

+60%

CAJONADO

+21

*Plazo de entrega 15 días (más información en pág. 288)

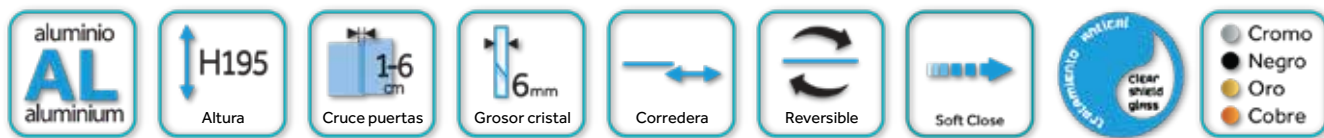

combinaciones **TWENTY COBRE** al vértice

Medida	Rangos	Apertura	Referencias	Puntos
70X70	65-70/65-70	30-35	2030+2030+2062	600
75X70	70-75/65-70	32-37	2031+2030+2062	605
80X70	75-80/65-70	34-39	2032+2030+2062	609
85X70	80-85/65-70	36-41	2033+2030+2062	614
90X70	85-90/65-70	38-43	2034+2030+2062	619
95X70	90-95/65-70	40-45	2035+2030+2062	623
100X70	95-100/65-70	42-47	2036+2030+2062	627
120X70	115-120/65-70	52-57	2037+2030+2062	646
Medida	Rangos	Apertura	Referencias	Puntos
75X75	70-75/70-75	34-39	2031+2031+2062	610
80X75	75-80/70-75	36-41	2032+2031+2062	614
85X75	80-85/70-75	38-43	2033+2031+2062	619
90X75	85-90/70-75	40-45	2034+2031+2062	624
95X75	90-95/70-75	42-47	2035+2031+2062	628
100X75	95-100/70-75	45-50	2036+2031+2062	632
120X75	115-120/70-75	54-59	2037+2031+2062	651
Medida	Rangos	Apertura	Referencias	Puntos
80X80	75-80/75-80	38-43	2032+2032+2062	618
85X80	80-85/75-80	40-45	2033+2032+2062	623
90X80	85-90/75-80	42-47	2034+2032+2062	628
95X80	90-95/75-80	45-50	2035+2032+2062	632
100X80	95-100/75-80	47-52	2036+2032+2062	636
120X80	115-120/75-80	56-61	2037+2032+2062	655
Medida	Rangos	Apertura	Referencias	Puntos
90X90	85-90/85-90	47-52	2034+2034+2062	638
95X90	90-95/85-90	49-54	2035+2034+2062	642
100X90	95-100/85-90	50-55	2036+2034+2062	646
120X90	115-120/85-90	60-65	2037+2034+2062	665

*Desglose por referencias/punto en página 306



Innovador sistema antivuelco



Rodamiento oculto

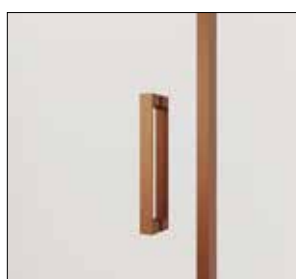

Doble asa metálica



Apertura soft close

TWENTY COBRE frontal + lateral fijo 6mm



Descripción	Rango	Ref.	Puntos
Lateral fijo TWENTY COBRE 70	66,5-69,5	2065	200
Lateral fijo TWENTY COBRE 75	71,5-74,5	2066	208
Lateral fijo TWENTY COBRE 80	76,5-79,5	2067	217
Lateral fijo TWENTY COBRE 90	86,5-89,5	2068	234



Laterales fijos a medida (más información en página 291)

Descripción	Referencias	Puntos	Cajonado
Lateral fijo a medida TWENTY hasta 40 cm	1375CB	227	+21
Lateral fijo a medida TWENTY de 40 hasta 80 cm	1376CB	306	+21
Lateral fijo a medida TWENTY de 80 hasta 120 cm	1377CB	376	+21

*Plazo de entrega 15 días

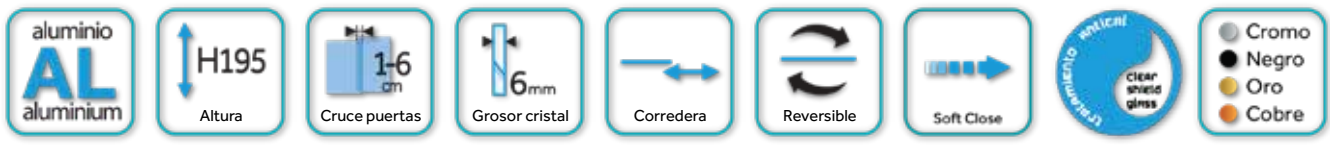

combinaciones frontales **TWENTY COBRE** + lateral fijo de 6 mm

Medida	Rangos	Referencias	Puntos
115x70	110-115/66,5-69,5	1999+2060+2065	617
120x70	115-120/66,5-69,5	2000+2060+2065	621
125x70	120-125/66,5-69,5	2001+2060+2065	625
130x70	125-130/66,5-69,5	2002+2060+2065	629
135x70	130-135/66,5-69,5	2003+2060+2065	633
140x70	135-140/66,5-69,5	2004+2060+2065	637
145x70	140-145/66,5-69,5	2005+2060+2065	641
150x70	145-150/66,5-69,5	2006+2060+2065	645
155x70	150-155/66,5-69,5	2007+2061+2065	673
160x70	155-160/66,5-69,5	2008+2061+2065	677
165x70	160-165/66,5-69,5	2009+2061+2065	681
170x70	165-170/66,5-69,5	2010+2061+2065	684
175x70	170-175/66,5-69,5	2011+2061+2065	689
180x70	175-180/66,5-69,5	2012+2061+2065	693
Medida	Rangos	Referencias	Puntos
115x80	110-115/76,5-79,5	1999+2060+2067	634
120x80	115-120/76,5-79,5	2000+2060+2067	638
125x80	120-125/76,5-79,5	2001+2060+2067	642
130x80	125-130/76,5-79,5	2002+2060+2067	646
135x80	130-135/76,5-79,5	2003+2060+2067	650
140x80	135-140/76,5-79,5	2004+2060+2067	654
145x80	140-145/76,5-79,5	2005+2060+2067	658
150x80	145-150/76,5-79,5	2006+2060+2067	662
155x80	150-155/76,5-79,5	2007+2061+2067	690
160x80	155-160/76,5-79,5	2008+2061+2067	694
165x80	160-165/76,5-79,5	2009+2061+2067	698
170x80	165-170/76,5-79,5	2010+2061+2067	701
175x80	170-175/76,5-79,5	2011+2061+2067	706
180x80	175-180/76,5-79,5	2012+2061+2067	710

Medida	Rangos	Referencias	Puntos
115x75	110-115/71,5-74,5	1999+2060+2066	625
120x75	115-120/71,5-74,5	2000+2060+2066	629
125x75	120-125/71,5-74,5	2001+2060+2066	633
130x75	125-130/71,5-74,5	2002+2060+2066	637
135x75	130-135/71,5-74,5	2003+2060+2066	641
140x75	135-140/71,5-74,5	2004+2060+2066	645
145x75	140-145/71,5-74,5	2005+2060+2066	649
150x75	145-150/71,5-74,5	2006+2060+2066	653
155x75	150-155/71,5-74,5	2007+2061+2066	681
160x75	155-160/71,5-74,5	2008+2061+2066	685
165x75	160-165/71,5-74,5	2009+2061+2066	689
170x75	165-170/71,5-74,5	2010+2061+2066	692
175x75	170-175/71,5-74,5	2011+2061+2066	697
180x75	175-180/71,5-74,5	2012+2061+2066	701
Medida	Rangos	Referencias	Puntos
115x90	110-115/86,5-89,5	1999+2060+2068	651
120x90	115-120/86,5-89,5	2000+2060+2068	655
125x90	120-125/86,5-89,5	2001+2060+2068	659
130x90	125-130/86,5-89,5	2002+2060+2068	663
135x90	130-135/86,5-89,5	2003+2060+2068	667
140x90	135-140/86,5-89,5	2004+2060+2068	671
145x90	140-145/86,5-89,5	2005+2060+2068	675
150x90	145-150/86,5-89,5	2006+2060+2068	679
155x90	150-155/86,5-89,5	2007+2061+2068	707
160x90	155-160/86,5-89,5	2008+2061+2068	711
165x90	160-165/86,5-89,5	2009+2061+2068	715
170x90	165-170/86,5-89,5	2010+2061+2068	718
175x90	170-175/86,5-89,5	2011+2061+2068	723
180x90	175-180/86,5-89,5	2012+2061+2068	727

Las aperturas son las mismas que en los frontales. Admite lateral fijo en ambos lados.



Guiador liberador de hoja



Rodamiento oculto



Doble asa metálica



Cierre/apertura soft close

kenna

8mm

“Diseño vanguardista
con ausencia de perflería
manteniendo la corredera
interior”

● 34-41 CROMO

● 42-49 NEGRO

● 50-57 ORO





KENNA 1 fijo + 1 corredera



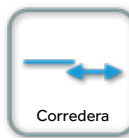
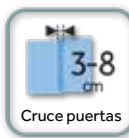

Frontales KENNA 1 fijo + 1 corredera

Descripción	Rango	Apertura	Ref.	Puntos
Frontal ducha KENNA 1F1C 100	95-100	34-39	6530CR	403
Frontal ducha KENNA 1F1C 105	100-105	37-42	6531CR	415
Frontal ducha KENNA 1F1C 110	105-110	39-44	6532CR	417
Frontal ducha KENNA 1F1C 115	110-115	42-47	6533CR	419
Frontal ducha KENNA 1F1C 120	115-120	44-49	6534CR	431
Frontal ducha KENNA 1F1C 125	120-125	47-52	6535CR	439
Frontal ducha KENNA 1F1C 130	125-130	49-54	6536CR	445
Frontal ducha KENNA 1F1C 135	130-135	52-57	6537CR	453
Frontal ducha KENNA 1F1C 140	135-140	52-57	6538CR	477
Frontal ducha KENNA 1F1C 145	140-145	57-62	6539CR	493
Frontal ducha KENNA 1F1C 150	145-150	57-62	6540CR	508
Frontal ducha KENNA 1F1C 155	150-155	62-67	6541CR	514
Frontal ducha KENNA 1F1C 160	155-160	64-69	6542CR	528
Frontal ducha KENNA 1F1C 165	160-165	64-69	6543CR	536
Frontal ducha KENNA 1F1C 170	165-170	64-69	6544CR	542
Frontal ducha KENNA 1F1C 175	170-175	64-69	6545CR	549
Frontal ducha KENNA 1F1C 180	175-180	64-69	6546CR	556

Desglose por referencias/punto en página 307



Barra orientable



Doble asa metálica



Rodamiento integrado en hoja



Opción tirador
Extraplano 22x1,6x0,7cm
Ref. 1731 - 20 puntos



Opción tirador
Largo 40x1,2x1,5cm
Ref. 1732 - 33 puntos



Opción barra paralela 200 cm, ref. 5546
Incremento 65 puntos



En el formato Free el rango se reduce en 2 cm

KENNA 2 fijos + 2 correderas



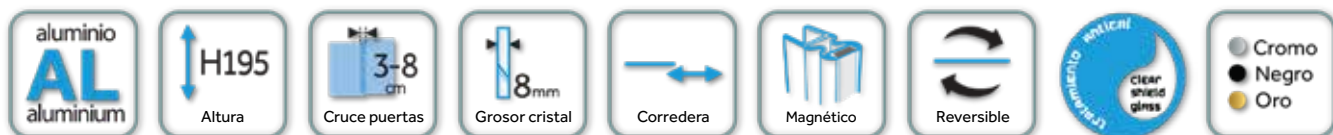

Frontales KENNA 2 fijos + 2 correderas

Descripción	Rango	Apertura	Ref.	Puntos
Frontal ducha KENNA 2F2C 140 (75+75)	131-141	41-51	KNSP140	668
Frontal ducha KENNA 2F2C 150 (80+80)	141-151	46-56	KNSP150	682
Frontal ducha KENNA 2F2C 160 (85+85)	151-161	51-61	KNSP160	688
Frontal ducha KENNA 2F2C 170 (90+90)	161-171	46-66	KNSP170	708
Frontal ducha KENNA 2F2C 180 (95+95)	171-181	61-71	KNSP180	722
Frontal ducha KENNA 2F2C 190 (100+100)	181-191	66-76	KNSP190	734
Frontal ducha KENNA 2F2C 200 (105+105)	196-206	75-85	KNSP200	758
Frontal ducha KENNA 2F2C 210 (110+110)	206-216	80-90	KNSP210	762
Frontal ducha KENNA 2F2C 220 (115+115)	216-226	85-95	KNSP220	766
Frontal ducha KENNA 2F2C 230 (120+120)	221-231	90-100	KNSP230	804

*Rangos calculados sin expandir el perfil +1,5 cm, por cada lado

Frontales KENNA XXL 2 fijos + 2 correderas

Descripción	Rango	Apertura	Ref.	Puntos
Frontal ducha KENNA 2F2C 240 (125+125)	234-244	95-105	KNSP240	898
Frontal ducha KENNA 2F2C 250 (130+130)	244-254	100-110	KNSP250	910
Frontal ducha KENNA 2F2C 260 (135+135)	254-264	105-115	KNSP260	926
Frontal ducha KENNA 2F2C 270 (140+140)	264-274	105-115	KNSP270	974
Frontal ducha KENNA 2F2C 280 (145+145)	274-284	115-125	KNSP280	1006
Frontal ducha KENNA 2F2C 290 (150+150)	284-294	115-125	KNSP290	1022
Frontal ducha KENNA 2F2C 300 (155+155)	294-304	125-135	KNSP300	1048
Frontal ducha KENNA 2F2C 310 (160+160)	304-314	130-140	KNSP310	1076

*Rangos calculados sin expandir el perfil +1,5 cm, por cada lado



Barra orientable



Doble asa metálica



Rodamiento integrado en hoja



Opción tirador
Extraplano 22x1,6x0,7cm
Ref. 1731 - 20 puntos



Opción tirador
Largo 40x1,2x1,5cm
Ref. 1732 - 33 puntos

KENNA angular al vértice



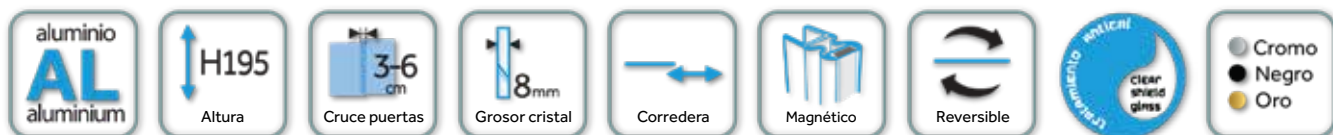

Combinaciones KENNA apertura al vértice

Medida	Rangos	Aperturas	Referencias	Puntos
70x70	65-70/65-70	32-35	KNAV7070	652
75x70	70-75/65-70	34-37	KNAV7570	658
80x70	75-80/65-70	36-39	KNAV8070	665
85x70	80-85/65-70	38-41	KNAV8570	668
90x70	85-90/65-70	40-43	KNAV9070	678
95x70	85-95/65-70	42-45	KNAV9570	685
100x70	95-100/65-70	44-47	KNAV10070	691
120x70	115-120/65-70	48-51	KNAV12070	726
75x75	70-75/70-75	36-39	KNAV7575	664
80x75	75-80/70-75	38-41	KNAV8075	671
85x75	80-85/70-75	40-43	KNAV8575	674
90x75	85-90/70-75	42-45	KNAV9075	684
95x75	85-95/70-75	44-47	KNAV9575	691
100x75	95-100/70-75	46-49	KNAV10075	697
120x75	115-120/70-75	50-53	KNAV12075	732
80x80	75-80/75-80	39-42	KNAV8080	678
85x80	80-85/75-80	41-44	KNAV8580	681
90x80	85-90/75-80	43-46	KNAV9080	691
95x80	85-95/75-80	45-48	KNAV9580	698
100x80	95-100/75-80	47-50	KNAV10080	704
120x80	115-120/75-80	51-54	KNAV12080	739
90x90	85-90/85-90	46-49	KNAV9090	704
95x90	85-95/85-90	48-51	KNAV9590	711
100x90	95-100/85-90	50-53	KNAV10090	717
120x90	115-120/85-90	54-57	KNAV12090	752
100x100	95-100/95-100	54-57	KNAV100100	730
120x100	115-120/95-100	58-61	KNAV120100	765
120x120	115-120/115-120	67-70	KNAV120120	800

*Rango máximo se obtiene expandiendo el perfil (+1,5cm)

*Desglose por referencias/punto en página 307



Barra orientable



Doble asa metálica



Rodamiento integrado en hoja



Opción tirador
Extraplano 22x1,6x0,7cm
Ref. 1731 - 20 puntos



Opción tirador
Largo 40x1,2x1,5cm
Ref. 1732 - 33 puntos

KENNA frontal + lateral fijo de 8 mm



Descripción	Rango	Ref.	Puntos
Lateral fijo KENNA 70	67-69	6547CR	209
Lateral fijo KENNA 75	72-74	6548CR	216
Lateral fijo KENNA 80	77-79	6549CR	223
Lateral fijo KENNA 90	87-89	6550CR	236

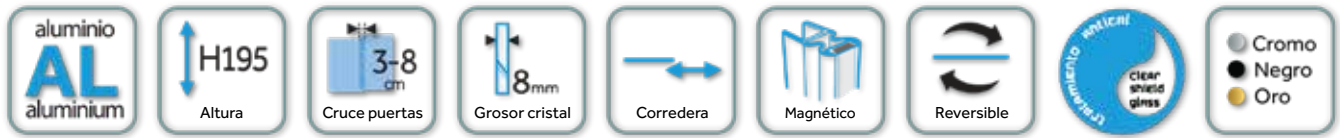

Combinaciones frontales KENNA + lateral fijo de 8 mm

Medida	Rangos	Referencias	Puntos	Medida	Rangos	Referencias	Puntos
100x70	95-100/67-69	KNAF10070	612	100x75	95-100/72-74	KNAF10075	619
110x70	105-110/67-69	KNAF11070	626	110x75	105-110/72-74	KNAF11075	633
120x70	115-120/67-69	KNAF12070	640	120x75	115-120/72-74	KNAF12075	647
130x70	125-130/67-69	KNAF13070	654	130x75	125-130/72-74	KNAF13075	661
140x70	135-140/67-69	KNAF14070	686	140x75	135-140/72-74	KNAF14075	693
150x70	145-150/67-69	KNAF15070	717	150x75	145-150/72-74	KNAF15075	724
160x70	155-160/67-69	KNAF16070	737	160x75	155-160/72-74	KNAF16075	744
170x70	165-170/67-69	KNAF17070	751	170x75	165-170/72-74	KNAF17075	758
180x70	175-180/67-69	KNAF18070	765	180x75	175-180/72-74	KNAF18075	772
Medida	Rangos	Referencias	Puntos	Medida	Rangos	Referencias	Puntos
100x80	95-100/77-79	KNAF10080	626	100x90	95-100/87-89	KNAF10090	639
110x80	105-110/77-79	KNAF11080	640	110x90	105-110/87-89	KNAF11090	653
120x80	115-120/77-79	KNAF12080	654	120x90	115-120/87-89	KNAF12090	667
130x80	125-130/77-79	KNAF13080	668	130x90	125-130/87-89	KNAF13090	681
140x80	135-140/77-79	KNAF14080	700	140x90	135-140/87-89	KNAF14090	713
150x80	145-150/77-79	KNAF15080	731	150x90	145-150/87-89	KNAF15090	744
160x80	155-160/77-79	KNAF16080	751	160x90	155-160/87-89	KNAF16090	764
170x80	165-170/77-79	KNAF17080	765	170x90	165-170/87-89	KNAF17090	778
180x80	175-180/77-79	KNAF18080	779	180x90	175-180/87-89	KNAF18090	792

Se pueden hacer combinaciones con medidas intermedias de frontales y hasta 175 cm. La apertura es +2 cm que en el frontal.



Opción barra paralela 200 cm, ref. 5546
Incremento 65 puntos



Opción tirador
Extraplano 22x1,6x0,7cm
Ref. 1731 - 20 puntos



Opción tirador
Largo 40x1,2x1,5cm
Ref. 1732 - 33 puntos



Laterales fijos a medida (más información en página 291)

Descripción	Ref.	Puntos	Cajonado
medida hasta 40 cm	1365	257	+21
medida de 40 hasta 80 cm	1366	342	+21
medida de 80 hasta 120 cm	1367	412	+21

*Plazo de entrega 15 días

KENNA NEGRA 1 fijo + 1 corredera



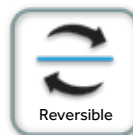
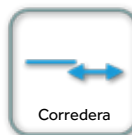
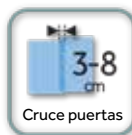

Frontales KENNA NEGRA 1 fijo + 1 corredera

KENNA

Descripción	Rango	Apertura	Ref.	Puntos
Frontal ducha KENNA 1F1C NEGRA 100	95-100	34-39	6530N	413
Frontal ducha KENNA 1F1C NEGRA 105	100-105	37-42	6531N	425
Frontal ducha KENNA 1F1C NEGRA 110	105-110	39-44	6532N	427
Frontal ducha KENNA 1F1C NEGRA 115	110-115	42-47	6533N	429
Frontal ducha KENNA 1F1C NEGRA 120	115-120	44-49	6534N	441
Frontal ducha KENNA 1F1C NEGRA 125	120-125	47-52	6535N	449
Frontal ducha KENNA 1F1C NEGRA 130	125-130	49-54	6536N	455
Frontal ducha KENNA 1F1C NEGRA 135	130-135	52-57	6537N	463
Frontal ducha KENNA 1F1C NEGRA 140	135-140	52-57	6538N	487
Frontal ducha KENNA 1F1C NEGRA 145	140-145	57-62	6539N	503
Frontal ducha KENNA 1F1C NEGRA 150	145-150	57-62	6540N	511
Frontal ducha KENNA 1F1C NEGRA 155	150-155	62-67	6541N	524
Frontal ducha KENNA 1F1C NEGRA 160	155-160	64-69	6542N	538
Frontal ducha KENNA 1F1C NEGRA 165	160-165	64-69	6543N	546
Frontal ducha KENNA 1F1C NEGRA 170	165-170	64-69	6544N	552
Frontal ducha KENNA 1F1C NEGRA 175	170-175	64-69	6545N	559
Frontal ducha KENNA 1F1C NEGRA 180	175-180	64-69	6546N	566

Desglose por referencias/punto en página 307



Barra orientable



Doble asa metálica



Rodamiento integrado en hoja



Opción tirador
Extraplano 22x1,6x0,7cm
Ref. 9031 - 20puntos



Opción tirador
Largo 40x1,2x1,5cm
Ref. 1732N - 33puntos



Opción barra paralela 200 cm, ref. 5546N
Incremento 65 puntos



En el formato Free el rango se reduce en 2 cm

KENNA NEGRA 2 fijos + 2 correderas



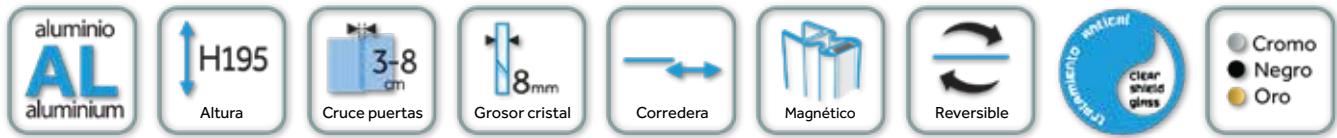

Frontales KENNA NEGRA 2 fijos + 2 correderas

Descripción	Rango	Apertura	Ref.	Puntos
Frontal ducha KENNA NEGRA 2F2C 140 (75+75)	131-141	41-51	KNSP140N	678
Frontal ducha KENNA NEGRA 2F2C 150 (80+80)	141-151	46-56	KNSP150N	692
Frontal ducha KENNA NEGRA 2F2C 160 (85+85)	151-161	51-61	KNSP160N	698
Frontal ducha KENNA NEGRA 2F2C 170 (90+90)	161-171	46-66	KNSP170N	718
Frontal ducha KENNA NEGRA 2F2C 180 (95+95)	171-181	61-71	KNSP180N	732
Frontal ducha KENNA NEGRA 2F2C 190 (100+100)	181-191	66-76	KNSP190N	744
Frontal ducha KENNA NEGRA 2F2C 200 (105+105)	196-206	75-85	KNSP200N	768
Frontal ducha KENNA NEGRA 2F2C 210 (110+110)	206-216	80-90	KNSP210N	772
Frontal ducha KENNA NEGRA 2F2C 220 (115+115)	216-226	85-95	KNSP220N	776
Frontal ducha KENNA NEGRA 2F2C 230 (120+120)	221-231	90-100	KNSP230N	814

*Rangos calculados sin expandir el perfil +1,5 cm, por cada lado

Frontales KENNA NEGRA XXL 2 fijos + 2 correderas

Descripción	Rango	Apertura	Ref.	Puntos
Frontal ducha KENNA NEGRA 2F2C 240 (125+125)	234-244	95-105	KNSP240N	918
Frontal ducha KENNA NEGRA 2F2C 250 (130+130)	244-254	100-110	KNSP250N	930
Frontal ducha KENNA NEGRA 2F2C 260 (135+135)	254-264	105-115	KNSP260N	946
Frontal ducha KENNA NEGRA 2F2C 270 (140+140)	264-274	105-115	KNSP270N	994
Frontal ducha KENNA NEGRA 2F2C 280 (145+145)	274-284	115-125	KNSP280N	1026
Frontal ducha KENNA NEGRA 2F2C 290 (150+150)	284-294	115-125	KNSP290N	1042
Frontal ducha KENNA NEGRA 2F2C 300 (155+155)	294-304	125-135	KNSP300N	1068
Frontal ducha KENNA NEGRA 2F2C 310 (160+160)	304-314	130-140	KNSP310N	1096

*Rangos calculados sin expandir el perfil +1,5 cm, por cada lado



Barra orientable



Doble asa metálica



Rodamiento integrado en hoja



Opción tirador
Extraplano 22x1,6x0,7cm
Ref. 9031 - 20puntos



Opción tirador
Largo 40x1,2x1,5cm
Ref. 1732N - 33puntos

KENNA NEGRA angular al vértice



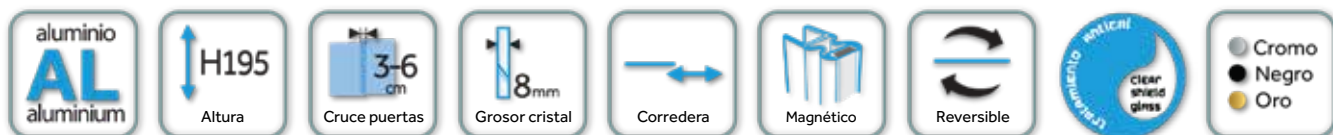

Combinaciones KENNA NEGRA apertura al vértice

Medida	Rangos	Aperturas	Referencias	Puntos
70x70	65-70/65-70	30-33	KNAV7070N	662
75x70	70-75/65-70	34-37	KNAV7570N	668
80x70	75-80/65-70	36-39	KNAV8070N	675
85x70	80-85/65-70	38-41	KNAV8570N	678
90x70	85-90/65-70	40-43	KNAV9070N	688
95x70	85-95/65-70	42-45	KNAV9570N	695
100x70	95-100/65-70	44-47	KNAV10070N	701
120x70	115-120/65-70	48-51	KNAV12070N	736
75x75	70-75/70-75	36-39	KNAV7575N	674
80x75	75-80/70-75	38-41	KNAV8075N	681
85x75	80-85/70-75	40-43	KNAV8575N	684
90x75	85-90/70-75	42-45	KNAV9075N	694
95x75	85-95/70-75	44-47	KNAV9575N	701
100x75	95-100/70-75	46-49	KNAV10075N	707
120x75	115-120/70-75	50-53	KNAV12075N	742
80x80	75-80/75-80	37-40	KNAV8080N	688
85x80	80-85/75-80	41-44	KNAV8580N	691
90x80	85-90/75-80	43-46	KNAV9080N	701
95x80	85-95/75-80	45-48	KNAV9580N	708
100x80	95-100/75-80	47-50	KNAV10080N	714
120x80	115-120/75-80	51-54	KNAV12080N	749
90x90	85-90/85-90	44-47	KNAV9090N	714
95x90	85-95/85-90	48-51	KNAV9590N	721
100x90	95-100/85-90	50-53	KNAV10090N	727
120x90	115-120/85-90	54-57	KNAV12090N	762
100x100	95-100/ 95-100	54-57	KNAV100100N	740
120x100	115-120/95-100	58-61	KNAV120100N	775
120x120	115-120/115-120	67-70	KNAV120120N	810

*Rango máximo se obtiene expandiendo el perfil (+1,5cm)

*Desglose por referencias/punto en página 307



Barra orientable



Doble asa metálica



Rodamiento integrado en hoja



Opción tirador
Extraplano 22x1,6x0,7cm
Ref. 9031 - 20puntos



Opción tirador
Largo 40x1,2x1,5cm
Ref. 1732N - 33puntos

KENNA NEGRA frontal + lateral fijo de 8 mm



Descripción	Rango	Ref.	Puntos
Lateral fijo KENNA 70	67-69	6547N	214
Lateral fijo KENNA 75	72-74	6548N	221
Lateral fijo KENNA 80	77-79	6549N	228
Lateral fijo KENNA 90	87-89	6550N	241

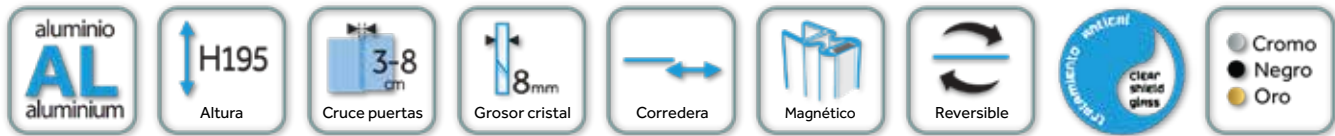

Combinaciones frontales KENNA NEGRA + lateral fijo de 8 mm

Medida	Rangos	Referencias	Puntos	Medida	Rangos	Referencias	Puntos
100x70	95-100/67-69	KNAF10070N	627	100x75	95-100/72-74	KNAF10075N	634
110x70	105-110/67-69	KNAF11070N	641	110x75	105-110/72-74	KNAF11075N	648
120x70	115-120/67-69	KNAF12070N	655	120x75	115-120/72-74	KNAF12075N	662
130x70	125-130/67-69	KNAF13070N	669	130x75	125-130/72-74	KNAF13075N	676
140x70	135-140/67-69	KNAF14070N	701	140x75	135-140/72-74	KNAF14075N	708
150x70	145-150/67-69	KNAF15070N	725	150x75	145-150/72-74	KNAF15075N	732
160x70	155-160/67-69	KNAF16070N	752	160x75	155-160/72-74	KNAF16075N	759
170x70	165-170/67-69	KNAF17070N	766	170x75	165-170/72-74	KNAF17075N	773
180x70	175-180/67-69	KNAF18070N	780	180x75	175-180/72-74	KNAF18075N	787
Medida	Rangos	Referencias	Puntos	Medida	Rangos	Referencias	Puntos
100x80	95-100/77-79	KNAF10080N	641	100x90	95-100/87-89	KNAF10090N	654
110x80	105-110/77-79	KNAF11080N	655	110x90	105-110/87-89	KNAF11090N	668
120x80	115-120/77-79	KNAF12080N	669	120x90	115-120/87-89	KNAF12090N	682
130x80	125-130/77-79	KNAF13080N	683	130x90	125-130/87-89	KNAF13090N	696
140x80	135-140/77-79	KNAF14080N	715	140x90	135-140/87-89	KNAF14090N	728
150x80	145-150/77-79	KNAF15080N	739	150x90	145-150/87-89	KNAF15090N	752
160x80	155-160/77-79	KNAF16080N	766	160x90	155-160/87-89	KNAF16090N	779
170x80	165-170/77-79	KNAF17080N	780	170x90	165-170/87-89	KNAF17090N	793
180x80	175-180/77-79	KNAF18080N	794	180x90	175-180/87-89	KNAF18090N	807

Se pueden hacer combinaciones con medidas intermedias de frontales y hasta 175 cm. La apertura es +2 cm que en el frontal.



Opción barra paralela 200 cm, ref. 5546N
Incremento 65 puntos



Opción tirador
Extraplano 22x1,6x0,7cm
Ref. 9031 - 20puntos



Opción tirador
Largo 40x1,2x1,5cm
Ref. 1732N - 33puntos



Laterales fijos a medida (más información en página 291)

Descripción	Ref.	Puntos	Cajonado
medida hasta 40 cm	1365N	262	+21
medida de 40 hasta 80 cm	1366N	347	+21
medida de 80 hasta 120 cm	1367N	417	+21

*Plazo de entrega 15 días

KENNA ORO 1 fijo + 1 corredera



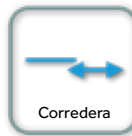

Frontales KENNA ORO 1 fijo + 1 corredera

Descripción	Rango	Apertura	Ref.	Puntos
Frontal ducha KENNA 1F1C ORO 100	95-100	34-39	6530OR	453
Frontal ducha KENNA 1F1C ORO 105	100-105	37-42	6531OR	465
Frontal ducha KENNA 1F1C ORO 110	105-110	39-44	6532OR	467
Frontal ducha KENNA 1F1C ORO 115	110-115	42-47	6533OR	469
Frontal ducha KENNA 1F1C ORO 120	115-120	44-49	6534OR	481
Frontal ducha KENNA 1F1C ORO 125	120-125	47-52	6535OR	489
Frontal ducha KENNA 1F1C ORO 130	125-130	49-54	6536OR	495
Frontal ducha KENNA 1F1C ORO 135	130-135	52-57	6537OR	503
Frontal ducha KENNA 1F1C ORO 140	135-140	52-57	6538OR	527
Frontal ducha KENNA 1F1C ORO 145	140-145	57-62	6539OR	544
Frontal ducha KENNA 1F1C ORO 150	145-150	57-62	6540OR	552
Frontal ducha KENNA 1F1C ORO 155	150-155	62-67	6541OR	565
Frontal ducha KENNA 1F1C ORO 160	155-160	64-69	6542OR	579
Frontal ducha KENNA 1F1C ORO 165	160-165	64-69	6543OR	587
Frontal ducha KENNA 1F1C ORO 170	165-170	64-69	6544OR	593
Frontal ducha KENNA 1F1C ORO 175	170-175	64-69	6545OR	600
Frontal ducha KENNA 1F1C ORO 180	175-180	64-69	6546OR	607

Desglose por referencias/punto en página 307



Barra orientable



Doble asa metálica

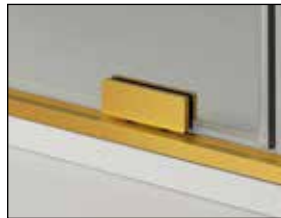

Rodamiento integrado en hoja



Opción tirador
Extraplano 22x1,6x0,7cm
R. 1731OR - 25puntos



Opción tirador
Largo 40x1,2x1,5cm
R. 1732OR - 38puntos



Opción barra paralela 200 cm ref. 5546OR
Incremento 80 puntos



En el formato Free el rango se reduce en 2 cm

KENNA ORO 2 fijos + 2 correderas



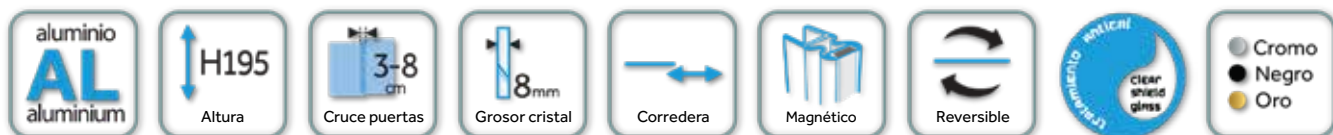

Frontales KENNA ORO 2 fijos + 2 correderas

Descripción	Rango	Apertura	Ref.	Puntos
Frontal ducha KENNA ORO 2F2C 140 (75+75)	131-141	41-51	KNSP140OR	749
Frontal ducha KENNA ORO 2F2C 150 (80+80)	141-151	46-56	KNSP150OR	763
Frontal ducha KENNA ORO 2F2C 160 (85+85)	151-161	51-61	KNSP160OR	769
Frontal ducha KENNA ORO 2F2C 170 (90+90)	161-171	46-66	KNSP170OR	789
Frontal ducha KENNA ORO 2F2C 180 (95+95)	171-181	61-71	KNSP180OR	803
Frontal ducha KENNA ORO 2F2C 190 (100+100)	181-191	66-76	KNSP190OR	815
Frontal ducha KENNA ORO 2F2C 200 (105+105)	196-206	75-85	KNSP200OR	839
Frontal ducha KENNA ORO 2F2C 210 (110+110)	206-216	80-90	KNSP210OR	843
Frontal ducha KENNA ORO 2F2C 220 (115+115)	216-226	85-95	KNSP220OR	847
Frontal ducha KENNA ORO 2F2C 230 (120+120)	221-231	90-100	KNSP230OR	885

*Rangos calculados sin expandir el perfil +1,5 cm, por cada lado

Frontales KENNA ORO XXL 2 fijos + 2 correderas

Descripción	Rango	Apertura	Ref.	Puntos
Frontal ducha KENNA ORO 2F2C 240 (125+125)	234-244	95-105	KNSP240OR	1003
Frontal ducha KENNA ORO 2F2C 250 (130+130)	244-254	100-110	KNSP250OR	1015
Frontal ducha KENNA ORO 2F2C 260 (135+135)	254-264	105-115	KNSP260OR	1031
Frontal ducha KENNA ORO 2F2C 270 (140+140)	264-274	105-115	KNSP270OR	1079
Frontal ducha KENNA ORO 2F2C 280 (145+145)	274-284	115-125	KNSP280OR	1113
Frontal ducha KENNA ORO 2F2C 290 (150+150)	284-294	115-125	KNSP290OR	1129
Frontal ducha KENNA ORO 2F2C 300 (155+155)	294-304	125-135	KNSP300OR	1155
Frontal ducha KENNA ORO 2F2C 310 (160+160)	304-314	130-140	KNSP310OR	1183

*Rangos calculados sin expandir el perfil +1,5 cm, por cada lado



Barra orientable



Doble asa metálica



Rodamiento integrado en hoja



Opción tirador
Extraplano 22x1,6x0,7cm
R. 1731OR - 25puntos



Opción tirador
Largo 40x1,2x1,5cm
R. 1732OR - 38puntos

KENNA ORO angular al vértice



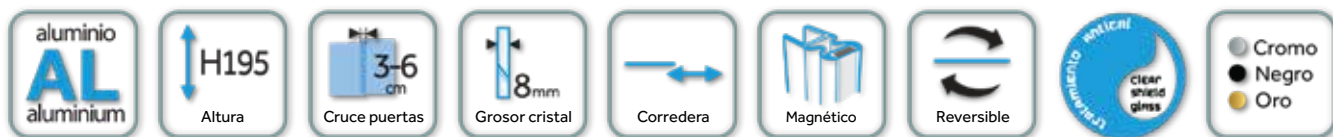

Combinaciones KENNA ORO apertura al vértice

Medida	Rangos	Aperturas	Referencias	Puntos
70x70	65-70/65-70	32-35	KNAV7070OR	733
75x70	70-75/65-70	34-37	KNAV7570OR	739
80x70	75-80/65-70	36-39	KNAV8070OR	746
85x70	80-85/65-70	38-41	KNAV8570OR	749
90x70	85-90/65-70	40-43	KNAV9070OR	759
95x70	85-95/65-70	42-45	KNAV9570OR	766
100x70	95-100/65-70	44-47	KNAV10070OR	772
120x70	115-120/65-70	48-51	KNAV12070OR	807
75x75	70-75/70-75	36-39	KNAV7575OR	745
80x75	75-80/70-75	38-41	KNAV8075OR	752
85x75	80-85/70-75	40-43	KNAV8575OR	755
90x75	85-90/70-75	42-45	KNAV9075OR	765
95x75	85-95/70-75	44-47	KNAV9575OR	772
100x75	95-100/70-75	46-49	KNAV10075OR	778
120x75	115-120/70-75	50-53	KNAV12075OR	813
80x80	75-80/75-80	39-42	KNAV8080OR	759
85x80	80-85/75-80	41-44	KNAV8580OR	762
90x80	85-90/75-80	43-46	KNAV9080OR	772
95x80	85-95/75-80	45-48	KNAV9580OR	779
100x80	95-100/75-80	47-50	KNAV10080OR	785
120x80	115-120/75-80	51-54	KNAV12080OR	820
90x90	85-90/85-90	46-49	KNAV9090OR	785
95x90	85-95/85-90	48-51	KNAV9590OR	792
100x90	95-100/85-90	50-53	KNAV10090OR	798
120x90	115-120/85-90	54-57	KNAV12090OR	833
100x100	95-100/95-100	54-57	KNAV100100OR	811
120x100	115-120/95-100	58-61	KNAV120100OR	846
120x120	115-120/115-120	67-70	KNAV120120OR	881

*Rango máximo se obtiene expandiendo el perfil (+1,5cm)

*Desglose por referencias/punto en página 307



Barra orientable



Doble asa metálica



Rodamiento integrado en hoja



Opción tirador
Extraplano 22x1,6x0,7cm
R. 1731OR - 25puntos



Opción tirador
Largo 40x1,2x1,5cm
R. 1732OR - 38puntos

KENNA ORO frontal + lateral fijo de 8 mm



Descripción	Rango	Ref.	Puntos
Lateral fijo KENNA 70	67-69	6547OR	232
Lateral fijo KENNA 75	72-74	6548OR	239
Lateral fijo KENNA 80	77-79	6549OR	246
Lateral fijo KENNA 90	87-89	6550OR	259

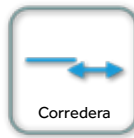

Combinaciones frontales **KENNA ORO** + lateral fijo de 8 mm

Medida	Rangos	Referencias	Puntos	Medida	Rangos	Referencias	Puntos
100x70	95-100/67-69	KNAF10070OR	685	100x75	95-100/72-74	KNAF10075OR	692
110x70	105-110/67-69	KNAF11070OR	699	110x75	105-110/72-74	KNAF11075OR	706
120x70	115-120/67-69	KNAF12070OR	713	120x75	115-120/72-74	KNAF12075OR	720
130x70	125-130/67-69	KNAF13070OR	727	130x75	125-130/72-74	KNAF13075OR	734
140x70	135-140/67-69	KNAF14070OR	759	140x75	135-140/72-74	KNAF14075OR	766
150x70	145-150/67-69	KNAF15070OR	784	150x75	145-150/72-74	KNAF15075OR	791
160x70	155-160/67-69	KNAF16070OR	811	160x75	155-160/72-74	KNAF16075OR	818
170x70	165-170/67-69	KNAF17070OR	825	170x75	165-170/72-74	KNAF17075OR	832
180x70	175-180/67-69	KNAF18070OR	839	180x75	175-180/72-74	KNAF18075OR	846
Medida	Rangos	Referencias	Puntos	Medida	Rangos	Referencias	Puntos
100x80	95-100/77-79	KNAF10080OR	699	100x90	95-100/87-89	KNAF10090OR	712
110x80	105-110/77-79	KNAF11080OR	713	110x90	105-110/87-89	KNAF11090OR	726
120x80	115-120/77-79	KNAF12080OR	727	120x90	115-120/87-89	KNAF12090OR	740
130x80	125-130/77-79	KNAF13080OR	741	130x90	125-130/87-89	KNAF13090OR	754
140x80	135-140/77-79	KNAF14080OR	773	140x90	135-140/87-89	KNAF14090OR	786
150x80	145-150/77-79	KNAF15080OR	798	150x90	145-150/87-89	KNAF15090OR	811
160x80	155-160/77-79	KNAF16080OR	825	160x90	155-160/87-89	KNAF16090OR	838
170x80	165-170/77-79	KNAF17080OR	839	170x90	165-170/87-89	KNAF17090OR	852
180x80	175-180/77-79	KNAF18080OR	853	180x90	175-180/87-89	KNAF18090OR	866

Se pueden hacer combinaciones con medidas intermedias de frontales y hasta 175 cm. La apertura es +2 cm que en el frontal.



Opción barra paralela 200 cm ref. 5546OR
Incremento 80 puntos



Opción tirador
Extraplano 22x1,6x0,7cm
R. 1731OR - 25puntos



Opción tirador
Largo 40x1,2x1,5cm
R. 1732OR - 38puntos









Laterales fijos a medida (más información en página 291)

Descripción	Ref.	Puntos	Cajonado
medida hasta 40 cm	1365OR	280	+21
medida de 40 hasta 80 cm	1366OR	365	+21
medida de 80 hasta 120 cm	1367OR	435	+21

*Plazo de entrega 15 días

basic

"Inmejorable relación
calidad-precio y amplitud
de formatos, medidas y
colores"

	CROMO	60-67
	NEGRO	68
	BLANCO	68
	ORO	70
	NÍQUEL	70
	COBRE	72
	TITANIO	72





BASIC 1 fijo + 1 corredera





H196

Altura



1-6 cm

Cruce puertas



6mm

Grosor cristal

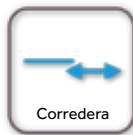

Corredera



Cierre burbuja

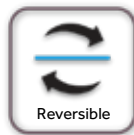

Reversible



aluminio
AL
aluminium



clear shield glass

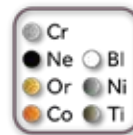

Cr Ne Bi
Or Ni
Co Ti

frontales **BASIC** 1 fijo + 1 corredera

Medida	Apertura	TRANSPARENTE		FROST PLUS	
		Ref.	Puntos	Ref.	Puntos
95-100	36-41	5401	321	6401	348
100-105	41-46	5402	328	6402	355
105-110	41-46	5403	334	6403	361
110-115	46-51	5404	339	6404	368
115-120	46-51	5405	343	6405	375
120-125	51-56	5406	350	6406	382
125-130	51-56	5407	355	6407	389
130-135	56-61	5408	359	6408	394
135-140	56-61	5409	365	6409	401
140-145	61-66	5410	378	6410	416
145-150	61-66	5411	383	6411	423
150-155	66-71	5412	390	6412	430
155-160	66-71	5413	395	6413	437
160-165	66-71	5414	399	6414	441
165-170	71-76	5415	401	6415	460
170-175	71-76	5416	407	6416	468
175-180	71-76	5417	413	6417	475
180-190	71-76	*5455	440	*6455	507
190-200	71-76	*5456	451	*6456	522

*El cruce de las referencias 5455, 5456, 6455 y 6456 será 1-11 cm.
Desglose por referencias/punto en página 304.

Descripción	Referencias	Puntos
Perfil de compensación +1,5 cm	5429	35
Pletina embellecedora 195x3,8 cm	0007	30



Guiador optimizado con pulsador liberador de hoja



Doble rodamiento regulable en nylon con antivuelco



Opción pletina embellecedora



Opción tirador	Ref.	P
Extraplano 22x1,6x0,7 cm	1731	20
Largo 40x1,2x1,5 cm	1732	33



Mamparas a medida y cristales especiales	TRANSPARENTE	FROST PLUS PARSOL / MATE
Altura hasta 195 cm	+45%	+60%
Altura de 195 hasta 220 cm	+75%	+90%

*Plazo de entrega 15 días (más información en pág. 288)

BASIC 2 fijos + 2 correderas



Descripción	Rango	Apertura	Cruce	Referencias	Puntos
BASIC 2F+2C 140 (75+75)	132-142	46-56	1-6	5029+5029+5451	479
BASIC 2F+2C 150 (80+80)	142-152	56-66	1-6	5019+5019+5451	489
BASIC 2F+2C 160 (85+85)	152-162	56-66	1-6	5030+5030+5451	501
BASIC 2F+2C 170 (90+90)	162-172	66-76	1-6	5020+5020+5451	511
BASIC 2F+2C 180 (95+95)	172-182	66-76	1-6	5031+5031+5454	521
BASIC 2F+2C 190 (100+100)	182-192	76-86	1-6	5021+5021+5454	525
BASIC 2F+2C 200 (100+100)	190-200	68-78	1-6	5001+5001+5454	531
BASIC 2F+2C 210 (105+105)	200-210	80-90	1-6	5002+5002+5454	545

Se puede combinar con lateral fijo (ver pág. 66), usando ref. 0182 (**indicar mano**). El rango aumenta 1,2 cm en uno de los lados.
***Desglose por referencias/punto en página 304.**

Descripción	Ref.	Puntos
Perfil de compensación +1,5 cm	5429	35
Perfil unión fijo-fijo (indicar mano), ver pág. 158	0182	40

Mamparas a medida y cristales especiales	TRANSP.	FROST PLUS PARSOL /MATE
Altura hasta 195 cm	+45%	+60%
Altura 195 hasta 220 cm	+75%	+90%

*Plazo de entrega 15 días (más información en pág. 288)

BASIC FROST PLUS 2 fijos + 2 correderas



BASIC

Descripción	Rango	Apertura	Cruce	Referencias	Puntos
BASIC 2F+2C FROST PLUS 140 (75+75)	132-142	46-56	1-6	6029+6029+5451	523
BASIC 2F+2C FROST PLUS 150 (80+80)	142-152	56-66	1-6	6019+6019+5451	531
BASIC 2F+2C FROST PLUS 160 (85+85)	152-162	56-66	1-6	6030+6030+5451	543
BASIC 2F+2C FROST PLUS 170 (90+90)	162-172	66-76	1-6	6020+6020+5451	553
BASIC 2F+2C FROST PLUS 180 (95+95)	172-182	66-76	1-6	6031+6031+5454	567
BASIC 2F+2C FROST PLUS 190 (100+100)	182-192	76-86	1-6	6021+6021+5454	579
BASIC 2F+2C FROST PLUS 200 (100+100)	190-200	68-78	1-6	6001+6001+5454	585
BASIC 2F+2C FROST PLUS 210 (105+105)	200-210	80-90	1-6	6002+6002+5454	599

Se puede combinar con lateral fijo (ver pág. 66), usando ref. 0182 (**indicar mano**). El rango aumenta 1,2 cm en uno de los lados.

***Desglose por referencias/punto en página 304.**

Descripción	Ref.	Puntos
Perfil de compensación +1,5 cm	5429	35
Perfil unión fijo-fijo (indicar mano), ver pág. 158	0182	40

Mamparas a medida y cristales especiales	TRANSP.	FROST PLUS PARSOL /MATE
Altura hasta 195 cm	+45%	+60%
Altura 195 hasta 220 cm	+75%	+90%

*Plazo de entrega 15 días (más información en pág. 288)

BASIC angular al vértice



Mamparas a medida y cristales especiales	TRANSPARENTE	FROST PLUS PARSOL / MATE	CAJONADO
Altura hasta 195 cm	+45%	+60%	+21
Altura de 195 hasta 220 cm	+75%	+90%	+21

*Plazo de entrega 15 días (más información en pág. 288)

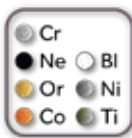
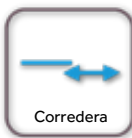

combinaciones angular **BASIC** apertura al vértice

Medida	Rangos	Apertura	TRANSPARENTE		FROST PLUS	
			Referencias	Puntos	Referencias	Puntos
70x70	65-70/65-70	34-37	5018+5018+5423	477	6018+6018+5423	519
75x70	70-75/65-70	36-39	5029+5018+5423	482	6029+6018+5423	525
80x70	75-80/65-70	38-41	5019+5018+5423	487	6019+6018+5423	529
85x70	80-85/65-70	40-43	5030+5018+5423	493	6030+6018+5423	535
90x70	85-90/65-70	41-45	5020+5018+5423	498	6020+6018+5423	540
95x70	90-95/65-70	43-47	5031+5018+5423	501	6031+6018+5423	545
100x70	95-100/65-70	46-49	5021+5018+5423	503	6021+6018+5423	551
110x70	105-109/65-70	47-50	5002+5018+5423	513	6002+6018+5423	561
120x70	115-120/65-70	50-53	5022+5018+5423	524	6022+6018+5423	582
130x70	125-129/65-70	55-58	5006+5018+5424	545	6006+6018+5424	598
140x70	135-139/65-70	59-62	5008+5018+5424	554	6008+6018+5424	610
Medida	Rangos	Apertura	Referencias	Puntos	Referencias	Puntos
75x75	70-75/70-75	38-41	5029+5029+5423	487	6029+6029+5423	531
80x75	75-80/70-75	40-43	5019+5029+5423	492	6019+6029+5423	535
85x75	80-85/70-75	42-45	5030+5029+5423	498	6030+6029+5423	541
90x75	85-90/70-75	45-48	5020+5029+5423	503	6020+6029+5423	546
95x75	90-95/70-75	47-50	5031+5029+5423	506	6031+6029+5423	551
100x75	95-100/70-75	48-51	5021+5029+5423	508	6021+6029+5423	557
110x75	105-109/70-75	49-52	5002+5029+5423	518	6002+6029+5423	567
120x75	115-120/70-75	52-55	5022+5029+5423	529	6022+6029+5423	588
130x75	125-129/70-75	57-60	5006+5029+5424	550	6006+6029+5424	604
140x75	135-139/70-75	61-64	5008+5029+5424	559	6008+6029+5424	616
Medida	Rangos	Apertura	Referencias	Puntos	Referencias	Puntos
80x80	75-80/75-80	41-44	5019+5019+5423	497	6019+6019+5423	539
85x80	80-85/75-80	43-46	5030+5019+5423	503	6030+6019+5423	545
90x80	85-90/75-80	45-48	5020+5019+5423	508	6020+6019+5423	550
95x80	90-95/75-80	47-50	5031+5019+5423	511	6031+6019+5423	555
100x80	95-100/75-80	49-52	5021+5019+5423	513	6021+6019+5423	561
110x80	105-109/75-80	50-53	5002+5019+5423	523	6002+6019+5423	571
120x80	115-120/75-80	53-56	5022+5019+5423	534	6022+6019+5423	592
130x80	125-129/75-80	57-60	5006+5019+5424	555	6006+6019+5424	608
140x80	135-139/75-80	62-65	5008+5019+5424	564	6008+6019+5424	620
Medida	Rangos	Apertura	Referencias	Puntos	Referencias	Puntos
85x90	80-85/85-90	46-49	5030+5020+5423	514	6030+6020+5423	556
90x90	85-90/85-90	48-51	5020+5020+5423	519	6020+6020+5423	561
95x90	90-95/85-90	50-53	5031+5020+5423	522	6031+6020+5423	566
100x90	95-100/85-90	52-55	5021+5020+5423	524	6021+6020+5423	572
110x90	105-109/85-90	53-56	5002+5020+5423	534	6002+6020+5423	582
120x90	115-120/85-90	57-62	5022+5020+5423	545	6022+6020+5423	603
130x90	125-129/85-90	60-63	5006+5020+5424	566	6006+6020+5424	619
140x90	135-139/85-90	64-67	5008+5020+5424	575	6008+6020+5424	631

*Desglose por referencias/punto en página 304.

Descripción	Referencias	Puntos
Perfil de compensación +1,5 cm	5429	35

BASIC

BASIC frontal + lateral fijo de 8 mm



Descripción	Rango	TRANSPARENTE		FROST PLUS	
		Ref.	Puntos	Ref.	Puntos
lateral fijo BASIC 70	66,5-69	5425	205	6425	225
lateral fijo BASIC 75	71,5-74	5457	210	6457	230
lateral fijo BASIC 80	76,5-79	5426	215	6426	235
lateral fijo BASIC 90	86,5-89	5427	230	6427	250
lateral fijo BASIC 100	96,5-99	5430	245	6430	265
lateral fijo BASIC 110	106,5-109	5431	260	6431	280
lateral fijo BASIC 120	116,5-119	5432	275	6432	295

Descripción	TRANSPARENTE		FROST PLUS		Cajonado
	Ref.	Puntos	Ref.	Puntos	
medida hasta 40 cm	1350	216	1350+1312	338	+21
medida de 40 hasta 80 cm	1334	296	1334+1313	418	+21
medida de 80 hasta 120 cm	1335	366	1335+1315	488	+21

*Plazo de entrega 15 días

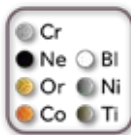
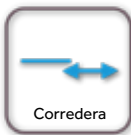

combinaciones frontales **BASIC** + lateral fijo de 8 mm

Medida	Rangos	Apertura
100x70	95-100/66,5-69	38-43
110x70	105-110/66,5-69	43-48
120x70	115-120/66,5-69	48-53
130x70	125-130/66,5-69	53-58
140x70	135-140/66,5-69	58-63
150x70	145-150/66,5-69	63-68
160x70	155-160/66,5-69	63-68
170x70	165-170/66,5-69	68-73
180x70	175-180/66,5-69	68-73

Medida	Rangos	Apertura
100x75	95-100/71,5-74	38-43
110x75	105-110/71,5-74	43-48
120x75	115-120/71,5-74	48-53
130x75	125-130/71,5-74	53-58
140x75	135-140/71,5-74	58-63
150x75	145-150/71,5-74	63-68
160x75	155-160/71,5-74	63-68
170x75	165-170/71,5-74	68-73
180x75	175-180/71,5-74	68-73

Medida	Rangos	Apertura
100x80	95-100/76,5-79	38-43
110x80	105-110/76,5-79	43-48
120x80	115-120/76,5-79	48-53
130x80	125-130/76,5-79	53-58
140x80	135-140/76,5-79	58-63
150x80	145-150/76,5-79	63-68
160x80	155-160/76,5-79	63-68
170x80	165-170/76,5-79	68-73
180x80	175-180/76,5-79	68-73

Medida	Rangos	Apertura
100x90	95-100/86,5-89	38-43
110x90	105-110/86,5-89	43-48
120x90	115-120/86,5-89	48-53
130x90	125-130/86,5-89	53-58
140x90	135-140/86,5-89	58-63
150x90	145-150/86,5-89	63-68
160x90	155-160/86,5-89	63-68
170x90	165-170/86,5-89	68-73
180x90	175-180/86,5-89	68-73

TRANSPARENTE	
Referencias	Puntos
5401+5425	526
5403+5425	539
5405+5425	548
5407+5425	560
5409+5425	570
5411+5425	588
5413+5425	600
5415+5425	606
5417+5425	618

Referencias	Puntos
5401+5457	531
5403+5457	544
5405+5457	553
5407+5457	565
5409+5457	575
5411+5457	593
5413+5457	605
5415+5457	611
5417+5457	623

Referencias	Puntos
5401+5426	536
5403+5426	549
5405+5426	558
5407+5426	570
5409+5426	580
5411+5426	598
5413+5426	610
5415+5426	616
5417+5426	628

Referencias	Puntos
5401+5427	551
5403+5427	564
5405+5427	573
5407+5427	585
5409+5427	595
5411+5427	613
5413+5427	625
5415+5427	631
5417+5427	643

FROST PLUS	
Referencias	Puntos
6401+6425	573
6403+6425	586
6405+6425	600
6407+6425	614
6409+6425	626
6411+6425	648
6413+6425	662
6415+6425	685
6417+6425	700

Referencias	Puntos
6401+6457	578
6403+6457	591
6405+6457	605
6407+6457	619
6409+6457	631
6411+6457	653
6413+6457	667
6415+6457	690
6417+6457	705

Referencias	Puntos
6401+6426	583
6403+6426	596
6405+6426	610
6407+6426	624
6409+6426	636
6411+6426	658
6413+6426	672
6415+6426	695
6417+6426	710

Referencias	Puntos
6401+6427	598
6403+6427	611
6405+6427	625
6407+6427	639
6409+6427	651
6411+6427	673
6413+6427	687
6415+6427	710
6417+6427	725

Se pueden hacer combinaciones con medidas intermedias de frontales y hasta 2 metros.

Descripción	Referencias	Puntos
Perfil de compensación +1,5 cm (solo para los frontales)	5429	35
Opción perfil unión fijo-fijo (indicar mano), ver pág. 158	0182	40

BASIC

BASIC COLOR 1 fijo + 1 corredera



Gomas transparentes anti-coloración



Doble rodamiento regulable en nylon con antivuelco



*Juego 2 gomas verticales negras ref. 0014, 15 puntos



Guiador optimizado con pulsador liberador de hoja



H196

Altura



1-6 cm

Cruce puertas



6mm

Grosor cristal

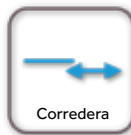

Corredera



Cierre burbuja

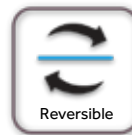

Reversible



aluminio
AL
aluminium



clear solid glass



Cr Ne BI
Or Ni
Co TI

Rango	Apert.	TRANSPARENTE			FROST PLUS		
		● NEGRO	● BLANCO	Puntos	● NEGRO	● BLANCO	Puntos
95-100	36-41	5001+5493	5001+5583	321	6001+5493	6001+5583	348
100-105	41-46	5002+5493	5002+5583	328	6002+5493	6002+5583	355
105-110	41-46	5003+5493	5003+5583	334	6003+5493	6003+5583	361
110-115	46-51	5004+5493	5004+5583	339	6004+5493	6004+5583	368
115-120	46-51	5005+5493	5005+5583	343	6005+5493	6005+5583	375
120-125	51-56	5006+5493	5006+5583	350	6006+5493	6006+5583	382
125-130	51-56	5007+5493	5007+5583	355	6007+5493	6007+5583	389
130-135	56-61	5008+5493	5008+5583	359	6008+5493	6008+5583	394
135-140	56-61	5009+5493	5009+5583	365	6009+5493	6009+5583	401
140-145	61-66	5010+5494	5010+5584	378	6010+5494	6010+5584	416
145-150	61-66	5011+5494	5011+5584	383	6011+5494	6011+5584	423
150-155	66-71	5012+5494	5012+5584	390	6012+5494	6012+5584	430
155-160	66-71	5013+5494	5013+5584	395	6013+5494	6013+5584	437
160-165	66-71	5014+5494	5014+5584	399	6014+5494	6014+5584	441
165-170	71-76	5015L+5494	5015L+5584	401	6015L+5494	6015L+5584	460
170-175	71-76	5016L+5494	5016L+5584	407	6016L+5494	6016L+5584	468
175-180	71-76	5017L+5494	5017L+5584	413	6017L+5494	6017L+5584	475
180-190	71-76	5023L+5495	5023L+5585	440	6023L+5495	6023L+5585	507
190-200	71-76	5024L+5495	5024L+5585	451	6024L+5495	6024L+5585	522

Desglose por referencias/punto en página 304.

Accesorios	● NEGRO		● BLANCO	
	Referencia	Puntos	Referencia	Puntos
Perfil de compensación +1,5 cm	5477	35	5473	35
Pletina embellecedora 195x3,8 cm	0007N	30	0007B	30
Opciones tiradores	Referencia	Puntos	Referencia	Puntos
Tirador extraplano 220x16x7mm	9031	20	1731BL	20
Tirador largo 400x12x15mm	1732N	33	1732BL	33



Opción pletina negra embellecedora



Opción pletina blanca embellecedora



Tirador negro extraplano 220x16x7mm



Tirador blanco extralargo 400x12x15mm



Mamparas a medida y cristales especiales

	TRANSPARENTE	FROST PLUS PARSOL / MATE	CAJONADO
	+45%	+60%	+21

*Plazo de entrega 15 días (más información en pág. 288)

BASIC COLOR 1 fijo + 1 corredera



Gomas transparentes anti-coloración



Doble rodamiento regulable en nylon con antivuelco



Perfecto acabado interior/externo



Guiador optimizado con pulsador liberador de hoja

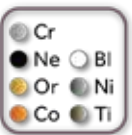

Rango	Apert.	TRANSPARENTE			FROST PLUS		
		ORO	NÍQUEL	Puntos	ORO	NÍQUEL	Puntos
95-100	36-41	5001+5440	5001+5460	355	6001+5440	6001+5460	382
100-105	41-46	5002+5440	5002+5460	362	6002+5440	6002+5460	389
105-110	41-46	5003+5440	5003+5460	368	6003+5440	6003+5460	395
110-115	46-51	5004+5440	5004+5460	373	6004+5440	6004+5460	402
115-120	46-51	5005+5440	5005+5460	377	6005+5440	6005+5460	409
120-125	51-56	5006+5440	5006+5460	384	6006+5440	6006+5460	416
125-130	51-56	5007+5440	5007+5460	389	6007+5440	6007+5460	423
130-135	56-61	5008+5440	5008+5460	393	6008+5440	6008+5460	428
135-140	56-61	5009+5440	5009+5460	399	6009+5440	6009+5460	435
140-145	61-66	5010+5441	5010+5461	411	6010+5441	6010+5461	449
145-150	61-66	5011+5441	5011+5461	416	6011+5441	6011+5461	456
150-155	66-71	5012+5441	5012+5461	423	6012+5441	6012+5461	463
155-160	66-71	5013+5441	5013+5461	428	6013+5441	6013+5461	470
160-165	66-71	5014+5441	5014+5461	432	6014+5441	6014+5461	474
165-170	71-76	5015L+5441	5015L+5461	434	6015L+5441	6015L+5461	493
170-175	71-76	5016L+5441	5016L+5461	440	6016L+5441	6016L+5461	501
175-180	71-76	5017L+5441	5017L+5461	446	6017L+5441	6017L+5461	508
180-190	71-76	5023L+5442	5023L+5462	469	6023L+5442	6023L+5462	536
190-200	71-76	5024L+5442	5024L+5462	480	6024L+5442	6024L+5462	551

Desglose por referencias/punto en página 304.

Accesorios
Perfil de compensación +1,5 cm
Pletina embellecedora 195x3,8 cm
Opciones tiradores
Tirador extraplano 220x16x7mm
Tirador largo 400x12x15mm

ORO	
Referencia	Puntos
5474	45
0007OR	40
Referencia	Puntos
1731OR	25
1732OR	38

NÍQUEL	
Referencia	Puntos
5475	45
0007NK	40
Referencia	Puntos
1731NK	25
1732NK	38



Opción pletina oro embellecedora



Opción pletina níquel embellecedora



Tirador extraplano oro 220x16x7mm



Tirador extralargo níquel 400x12x15mm



Mamparas a medida y cristales especiales

TRANSPARENTE	FROST PLUS PARSOL / MATE	CAJONADO
+45%	+60%	+21

*Plazo de entrega 15 días (más información en pág. 288)

BASIC COLOR 1 fijo + 1 corredera



Gomas transparentes anti-coloración



Doble rodamiento regulable en nylon con antivuelco



Perfecto acabado interior/externo



Guiador optimizado con pulsador liberador de hoja

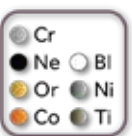

Rango	Apert.	TRANSPARENTE			FROST PLUS		
		COBRE	TITANIO	Puntos	COBRE	TITANIO	Puntos
95-100	36-41	5001+5592	5001+5560	355	6001+5592	6001+5560	382
100-105	41-46	5002+5592	5002+5560	362	6002+5592	6002+5560	389
105-110	41-46	5003+5592	5003+5560	368	6003+5592	6003+5560	395
110-115	46-51	5004+5592	5004+5560	373	6004+5592	6004+5560	402
115-120	46-51	5005+5592	5005+5560	377	6005+5592	6005+5560	409
120-125	51-56	5006+5592	5006+5560	384	6006+5592	6006+5560	416
125-130	51-56	5007+5592	5007+5560	389	6007+5592	6007+5560	423
130-135	56-61	5008+5592	5008+5560	393	6008+5592	6008+5560	428
135-140	56-61	5009+5592	5009+5560	399	6009+5592	6009+5560	435
140-145	61-66	5010+5593	5010+5561	411	6010+5593	6010+5561	449
145-150	61-66	5011+5593	5011+5561	416	6011+5593	6011+5561	456
150-155	66-71	5012+5593	5012+5561	423	6012+5593	6012+5561	463
155-160	66-71	5013+5593	5013+5561	428	6013+5593	6013+5561	470
160-165	66-71	5014+5593	5014+5561	432	6014+5593	6014+5561	474
165-170	71-76	5015L+5593	5015L+5561	434	6015L+5593	6015L+5561	493
170-175	71-76	5016L+5593	5016L+5561	440	6016L+5593	6016L+5561	501
175-180	71-76	5017L+5593	5017L+5561	446	6017L+5593	6017L+5561	508
180-190	71-76	5023L+5594	5023L+5562	469	6023L+5594	6023L+5562	536
190-200	71-76	5024L+5594	5024L+5562	480	6024L+5594	6024L+5562	551

Desglose por referencias/punto en página 304.

Accesorios	COBRE		TITANIO	
	Referencia	Puntos	Referencia	Puntos
Perfil de compensación +1,5 cm	5476	45	5478	45
Pletina embellecedora 195x3,8 cm	0007CB	40	0007T	40
Opciones tiradores	Referencia	Puntos	Referencia	Puntos
Tirador extraplano 220x16x7mm	1731CB	25	1731T	25
Tirador largo 400x12x15mm	1732CB	38	1732T	38



Opción pletina cobre embellecedora



Opción pletina titanio embellecedora



Tirador extraplano cobre 220x16x7mm



Tirador extralargo titanio 400x12x15mm



Mamparas a medida y cristales especiales

TRANSPARENTE	FROST PLUS PARSOL / MATE	CAJONADO
+45%	+60%	+21

*Plazo de entrega 15 días (más información en pág. 288)

BASIC NEGRA 2 fijos + 2 correderas



Rango	Apert.	TRANSPARENTE	Puntos	FROST PLUS	Puntos
132-142	46-56	5029+5029+5496	479	6029+6029+5496	523
142-152	56-66	5019+5019+5496	489	6019+6019+5496	531
152-162	56-66	5030+5030+5496	501	6030+6030+5496	543
162-172	66-76	5020+5020+5496	511	6020+6020+5496	553
172-182	66-76	5031+5031+5497	521	6031+6031+5497	567
182-192	76-86	5021+5021+5497	525	6021+6021+5497	579
190-200	68-78	5001+5001+5497	531	6001+6001+5497	585
200-210	80-90	5002+5002+5497	545	6002+6002+5497	599

Se puede combinar con lateral fijo (ver pág. 87), usando ref. 0991 (**indicar mano**). El rango aumenta 1,2 cm en uno de los lados.
***Desglose por referencias/punto en página 304.**

Accesorios	Ref.	Puntos
Perfil de compensación +1,5 cm	5477	35
Pletina embellecedora 195x3,8 cm	0007N	30
Perfil unión fijo-fijo (indicar mano), ver pág.	0991	40

Mamparas a medida y cristales especiales	TRANSP.	FROST PLUS PARSOL /MATE
Altura hasta 195 cm	+45%	+60%
Altura 195 hasta 220 cm	+75%	+90%

*Plazo de entrega 15 días (más información en pág. 288)

BASIC BLANCA 2 fijos + 2 correderas

BASIC



Rango	Apert.	TRANSPARENTE	Puntos	FROST PLUS	Puntos
132-142	46-56	5029+5029+5586	479	6029+6029+5586	523
142-152	56-66	5019+5019+5586	489	6019+6019+5586	531
152-162	56-66	5030+5030+5586	501	6030+6030+5586	543
162-172	66-76	5020+5020+5586	511	6020+6020+5586	553
172-182	66-76	5031+5031+5587	521	6031+6031+5587	567
182-192	76-86	5021+5021+5587	525	6021+6021+5587	579
190-200	68-78	5001+5001+5587	531	6001+6001+5587	585
200-210	80-90	5002+5002+5587	545	6002+6002+5587	599

Se puede combinar con lateral fijo (ver pág. 87), usando ref. 0182B (indicar mano). El rango aumenta 1,2 cm en uno de los lados.
***Desglose por referencias/punto en página 304.**

Accesorios	Ref.	Puntos
Perfil de compensación +1,5 cm	5473	35
Pletina embellecedora 195x3,8 cm	0007B	30
Perfil unión fijo-fijo (indicar mano), ver pág.	0182B	40

Mamparas a medida y cristales especiales	TRANSP.	FROST PLUS PARSOL /MATE
Altura hasta 195 cm	+45%	+60%
Altura 195 hasta 220 cm	+75%	+90%

*Plazo de entrega 15 días (más información en pág. 288)

BASIC ORO 2 fijos + 2 correderas



Rango	Apert.	TRANSPARENTE	Puntos	FROST PLUS	Puntos
132-142	46-56	5029+5029+5498	512	6029+6029+5498	556
142-152	56-66	5019+5019+5498	522	6019+6019+5498	564
152-162	56-66	5030+5030+5498	534	6030+6030+5498	576
162-172	66-76	5020+5020+5498	544	6020+6020+5498	586
172-182	66-76	5031+5031+5499	580	6031+6031+5499	626
182-192	76-86	5021+5021+5499	584	6021+6021+5499	638
190-200	68-78	5001+5001+5499	590	6001+6001+5499	644
200-210	80-90	5002+5002+5499	604	6002+6002+5499	658

Se puede combinar con lateral fijo (ver pág. 89), usando ref. 0182OR (**indicar mano**). El rango aumenta 1,2 cm en uno de los lados.

***Desglose por referencias/punto en página 304.**

Accesorios	Ref.	Puntos
Perfil de compensación +1,5 cm	5474	45
Pletina embellecedora 195x3,8 cm	0007OR	40
Perfil unión fijo-fijo (indicar mano), ver pág. 158	0182OR	50

Mamparas a medida y cristales especiales	TRANSP.	FROST PLUS PARSOL /MATE
Altura hasta 195 cm	+45%	+60%
Altura 195 hasta 220 cm	+75%	+90%

*Plazo de entrega 15 días (más información en pág. 288)

BASIC NÍQUEL 2 fijos + 2 correderas

BASIC



Rango	Apert.	TRANSPARENTE	Puntos	FROST PLUS	Puntos
132-142	46-56	5029+5029+5465	512	6029+6029+5465	556
142-152	56-66	5019+5019+5465	522	6019+6019+5465	564
152-162	56-66	5030+5030+5465	534	6030+6030+5465	576
162-172	66-76	5020+5020+5465	544	6020+6020+5465	586
172-182	66-76	5031+5031+5466	580	6031+6031+5466	626
182-192	76-86	5021+5021+5466	584	6021+6021+5466	638
190-200	68-78	5001+5001+5466	590	6001+6001+5466	644
200-210	80-90	5002+5002+5466	604	6002+6002+5466	658

Se puede combinar con lateral fijo (ver pág. 89), usando ref. 0182NK (indicar mano). El rango aumenta 1,2 cm en uno de los lados.

*Desglose por referencias/punto en página 304.

Accesorios	Ref.	Puntos
Perfil de compensación +1,5 cm	5475	45
Pletina embellecedora 195x3,8 cm	0007NK	40
Perfil unión fijo-fijo (indicar mano), ver pág. 158	0182NK	50

Mamparas a medida y cristales especiales	TRANSP.	FROST PLUS PARSOL /MATE
Altura hasta 195 cm	+45%	+60%
Altura 195 hasta 220 cm	+75%	+90%

*Plazo de entrega 15 días (más información en pág. 288)

BASIC COBRE 2 fijos + 2 correderas



Rango	Apert.	TRANSPARENTE	Puntos	FROST PLUS	Puntos
132-142	46-56	5029+5029+5595	512	6029+6029+5595	556
142-152	56-66	5019+5019+5595	522	6019+6019+5595	564
152-162	56-66	5030+5030+5595	534	6030+6030+5595	576
162-172	66-76	5020+5020+5595	544	6020+6020+5595	586
172-182	66-76	5031+5031+5596	580	6031+6031+5596	626
182-192	76-86	5021+5021+5596	584	6021+6021+5596	638
190-200	68-78	5001+5001+5596	590	6001+6001+5596	644
200-210	80-90	5002+5002+5596	604	6002+6002+5596	658

Se puede combinar con lateral fijo (ver pág. 91), usando ref. 0182CB (indicar mano). El rango aumenta 1,2 cm en uno de los lados.

***Desglose por referencias/punto en página 304.**

Accesorios	Ref.	Puntos
Perfil de compensación +1,5 cm	5476	45
Pletina embellecedora 195x3,8 cm	0007CB	40
Perfil unión fijo-fijo (indicar mano), ver pág. 158	0182CB	50

Mamparas a medida y cristales especiales	TRANSP.	FROST PLUS PARSOL /MATE
Altura hasta 195 cm	+45%	+60%
Altura 195 hasta 220 cm	+75%	+90%

*Plazo de entrega 15 días (más información en pág. 288)

BASIC TITANIO 2 fijos + 2 correderas



Rango	Apert.	TRANSPARENTE	Puntos	FROST PLUS	Puntos
132-142	46-56	5029+5029+5565	512	6029+6029+5565	556
142-152	56-66	5019+5019+5565	522	6019+6019+5565	564
152-162	56-66	5030+5030+5565	534	6030+6030+5565	576
162-172	66-76	5020+5020+5565	544	6020+6020+5565	586
172-182	66-76	5031+5031+5566	580	6031+6031+5566	626
182-192	76-86	5021+5021+5566	584	6021+6021+5566	638
190-200	68-78	5001+5001+5566	590	6001+6001+5566	644
200-210	80-90	5002+5002+5566	604	6002+6002+5566	658

Se puede combinar con lateral fijo (ver pág. 91), usando ref. 0182T (indicar mano). El rango aumenta 1,2 cm en uno de los lados.

***Desglose por referencias/punto en página 304.**

Accesorios	Ref.	Puntos
Perfil de compensación +1,5 cm	5478	45
Pletina embellecedora 195x3,8 cm	0007T	40
Perfil unión fijo-fijo (indicar mano), ver pág. 158	0182T	50

Mamparas a medida y cristales especiales	TRANSP.	FROST PLUS PARSOL /MATE
Altura hasta 195 cm	+45%	+60%
Altura 195 hasta 220 cm	+75%	+90%

*Plazo de entrega 15 días (más información en pág. 288)

BASIC COLOR angular al vértice



Gomas transparentes anti-coloración



Doble rodamiento regulable en nylon con antivuelco



*Juego 2 gomas verticales negras ref. 0014, 15 puntos



Guiador optimizado con pulsador liberador de hoja

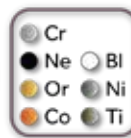
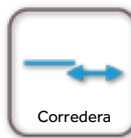

Rango	TRANSPARENTE			FROST PLUS		
	● NEGRO	● BLANCO	Puntos	● NEGRO	● BLANCO	Puntos
combinaciones c/ LADOS 70 fijo+corredera						
65-70/65-70	5018+5018+5490	5018+5018+5580	477	6018+6018+5490	6018+6018+5580	519
70-75/65-70	5029+5018+5490	5029+5018+5580	482	6029+6018+5490	6029+6018+5580	525
75-80/65-70	5019+5018+5490	5019+5018+5580	487	6019+6018+5490	6019+6018+5580	529
80-85/65-70	5030+5018+5490	5030+5018+5580	493	6030+6018+5490	6030+6018+5580	535
85-90/65-70	5020+5018+5490	5020+5018+5580	498	6020+6018+5490	6020+6018+5580	540
90-95/65-70	5031+5018+5490	5031+5018+5580	501	6031+6018+5490	6031+6018+5580	545
95-100/65-70	5021+5018+5490	5021+5018+5580	503	6021+6018+5490	6021+6018+5580	551
105-109/65-70	5002+5018+5490	5002+5018+5580	513	6002+6018+5490	6002+6018+5580	561
115-120/65-70	5022+5018+5490	5022+5018+5580	524	6022+6018+5490	6022+6018+5580	582
125-129/65-70	5006+5018+5491	5006+5018+5581	545	6006+6018+5491	6006+6018+5581	598
135-139/65-70	5008+5018+5491	5008+5018+5581	554	6008+6018+5491	6008+6018+5581	610
combinaciones c/ LADOS 75 fijo+corredera						
70-75/70-75	5029+5029+5490	5029+5029+5580	487	6029+6029+5490	6029+6029+5580	531
75-80/70-75	5019+5029+5490	5019+5029+5580	492	6019+6029+5490	6019+6029+5580	535
80-85/70-75	5030+5029+5490	5030+5029+5580	498	6030+6029+5490	6030+6029+5580	541
85-90/70-75	5020+5029+5490	5020+5029+5580	503	6020+6029+5490	6020+6029+5580	546
90-95/70-75	5031+5029+5490	5031+5029+5580	506	6031+6029+5490	6031+6029+5580	551
95-100/70-75	5021+5029+5490	5021+5029+5580	508	6021+6029+5490	6021+6029+5580	557
105-109/70-75	5002+5029+5490	5002+5029+5580	518	6002+6029+5490	6002+6029+5580	567
115-120/70-75	5022+5029+5490	5022+5029+5580	529	6022+6029+5490	6022+6029+5580	588
125-129/70-75	5006+5029+5491	5006+5029+5581	550	6006+6029+5491	6006+6029+5581	604
135-139/70-75	5008+5029+5491	5008+5029+5581	559	6008+6029+5491	6008+6029+5581	616
combinaciones c/ LADOS 80 fijo+corredera						
75-80/75-80	5019+5019+5490	5019+5019+5580	497	6019+6019+5490	6019+6019+5580	539
80-85/75-80	5030+5019+5490	5030+5019+5580	503	6030+6019+5490	6030+6019+5580	545
85-90/75-80	5020+5019+5490	5020+5019+5580	508	6020+6019+5490	6020+6019+5580	550
90-95/75-80	5031+5019+5490	5031+5019+5580	511	6031+6019+5490	6031+6019+5580	555
95-100/75-80	5021+5019+5490	5021+5019+5580	513	6021+6019+5490	6021+6019+5580	561
105-109/75-80	5002+5019+5490	5002+5019+5580	523	6002+6019+5490	6002+6019+5580	571
115-120/75-80	5022+5019+5490	5022+5019+5580	534	6022+6019+5490	6022+6019+5580	592
125-129/75-80	5006+5019+5491	5006+5019+5581	555	6006+6019+5491	6006+6019+5581	608
135-139/75-80	5008+5019+5491	5008+5019+5581	564	6008+6019+5491	6008+6019+5581	620
combinaciones c/ LADOS 90 fijo+corredera						
85-90/85-90	5020+5020+5490	5020+5020+5580	519	6020+6020+5490	6020+6020+5580	561
90-95/85-90	5031+5020+5490	5031+5020+5580	522	6031+6020+5490	6031+6020+5580	566
95-100/85-90	5021+5020+5490	5021+5020+5580	524	6021+6020+5490	6021+6020+5580	572
105-109/85-90	5002+5020+5490	5002+5020+5580	534	6002+6020+5490	6002+6020+5580	582
115-120/85-90	5022+5020+5490	5022+5020+5580	545	6022+6020+5490	6022+6020+5580	603
125-129/85-90	5006+5020+5491	5006+5020+5581	566	6006+6020+5491	6006+6020+5581	619
135-139/85-90	5008+5020+5491	5008+5020+5581	575	6008+6020+5491	6008+6020+5581	631

Desglose por referencias/punto en página 304. Aperturas ver página 65.

BASIC COLOR angular al vértice



Gomas transparentes anti-coloración



Doble rodamiento regulable en nylon con antivuelco



Perfecto acabado interior/externo



Guiador optimizado con pulsador liberador de hoja

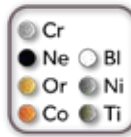
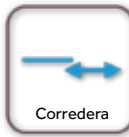

Rango	TRANSPARENTE			FROST PLUS		
	ORO	NÍQUEL	Puntos	ORO	NÍQUEL	Puntos
combinaciones c/ LADOS 70 fijo+corredera						
65-70/65-70	5018+5018+5448	5018+5018+5463	562	6018+6018+5448	6018+6018+5463	604
70-75/65-70	5029+5018+5448	5029+5018+5463	567	6029+6018+5448	6029+6018+5463	610
75-80/65-70	5019+5018+5448	5019+5018+5463	572	6019+6018+5448	6019+6018+5463	614
80-85/65-70	5030+5018+5448	5030+5018+5463	578	6030+6018+5448	6030+6018+5463	620
85-90/65-70	5020+5018+5448	5020+5018+5463	583	6020+6018+5448	6020+6018+5463	625
90-95/65-70	5031+5018+5448	5031+5018+5463	586	6031+6018+5448	6031+6018+5463	630
95-100/65-70	5021+5018+5448	5021+5018+5463	588	6021+6018+5448	6021+6018+5463	636
105-109/65-70	5002+5018+5448	5002+5018+5463	598	6002+6018+5448	6002+6018+5463	646
115-120/65-70	5022+5018+5448	5022+5018+5463	609	6022+6018+5448	6022+6018+5463	667
125-129/65-70	5006+5018+5449	5006+5018+5464	630	6006+6018+5449	6006+6018+5464	683
135-139/65-70	5008+5018+5449	5008+5018+5464	639	6008+6018+5449	6008+6018+5464	695
combinaciones c/ LADOS 75 fijo+corredera						
70-75/70-75	5029+5029+5448	5029+5029+5463	572	6029+6029+5448	6029+6029+5463	616
75-80/70-75	5019+5029+5448	5019+5029+5463	577	6019+6029+5448	6019+6029+5463	620
80-85/70-75	5030+5029+5448	5030+5029+5463	583	6030+6029+5448	6030+6029+5463	626
85-90/70-75	5020+5029+5448	5020+5029+5463	588	6020+6029+5448	6020+6029+5463	631
90-95/70-75	5031+5029+5448	5031+5029+5463	591	6031+6029+5448	6031+6029+5463	636
95-100/70-75	5021+5029+5448	5021+5029+5463	593	6021+6029+5448	6021+6029+5463	642
105-109/70-75	5002+5029+5448	5002+5029+5463	603	6002+6029+5448	6002+6029+5463	652
115-120/70-75	5022+5029+5448	5022+5029+5463	614	6022+6029+5448	6022+6029+5463	673
125-129/70-75	5006+5029+5449	5006+5029+5464	635	6006+6029+5449	6006+6029+5464	689
135-139/70-75	5008+5029+5449	5008+5029+5464	644	6008+6029+5449	6008+6029+5464	701
combinaciones c/ LADOS 80 fijo+corredera						
75-80/75-80	5019+5019+5448	5019+5019+5463	582	6019+6019+5448	6019+6019+5463	624
80-85/75-80	5030+5019+5448	5030+5019+5463	588	6030+6019+5448	6030+6019+5463	630
85-90/75-80	5020+5019+5448	5020+5019+5463	593	6020+6019+5448	6020+6019+5463	635
90-95/75-80	5031+5019+5448	5031+5019+5463	596	6031+6019+5448	6031+6019+5463	640
95-100/75-80	5021+5019+5448	5021+5019+5463	598	6021+6019+5448	6021+6019+5463	646
105-109/75-80	5002+5019+5448	5002+5019+5463	608	6002+6019+5448	6002+6019+5463	656
115-120/75-80	5022+5019+5448	5022+5019+5463	619	6022+6019+5448	6022+6019+5463	677
125-129/75-80	5006+5019+5449	5006+5019+5464	640	6006+6019+5449	6006+6019+5464	693
135-139/75-80	5008+5019+5449	5008+5019+5464	649	6008+6019+5449	6008+6019+5464	705
combinaciones c/ LADOS 90 fijo+corredera						
85-90/85-90	5020+5020+5448	5020+5020+5463	604	6020+6020+5448	6020+6020+5463	646
90-95/85-90	5031+5020+5448	5031+5020+5463	607	6031+6020+5448	6031+6020+5463	651
95-100/85-90	5021+5020+5448	5021+5020+5463	609	6021+6020+5448	6021+6020+5463	657
105-109/85-90	5002+5020+5448	5002+5020+5463	619	6002+6020+5448	6002+6020+5463	667
115-120/85-90	5022+5020+5448	5022+5020+5463	630	6022+6020+5448	6022+6020+5463	688
125-129/85-90	5006+5020+5449	5006+5020+5464	651	6006+6020+5449	6006+6020+5464	704
135-139/85-90	5008+5020+5449	5008+5020+5464	660	6008+6020+5449	6008+6020+5464	716

Desglose por referencias/punto en página 304. Aperturas ver página 65.

BASIC

BASIC COLOR angular al vértice



Gomas transparentes anti-coloración



Doble rodamiento regulable en nylon con antivuelco



Perfecto acabado interior/externo



Guiador optimizado con pulsador liberador de hoja

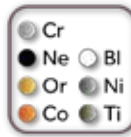
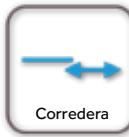

Rango	TRANSPARENTE			FROST PLUS		
	COBRE	TITANIO	Puntos	COBRE	TITANIO	Puntos
combinaciones c/ LADOS 70 fijo+corredera						
65-70/65-70	5018+5018+5590	5018+5018+5563	562	6018+6018+5590	6018+6018+5563	604
70-75/65-70	5029+5018+5590	5029+5018+5563	567	6029+6018+5590	6029+6018+5563	610
75-80/65-70	5019+5018+5590	5019+5018+5563	572	6019+6018+5590	6019+6018+5563	614
80-85/65-70	5030+5018+5590	5030+5018+5563	578	6030+6018+5590	6030+6018+5563	620
85-90/65-70	5020+5018+5590	5020+5018+5563	583	6020+6018+5590	6020+6018+5563	625
90-95/65-70	5031+5018+5590	5031+5018+5563	586	6031+6018+5590	6031+6018+5563	630
95-100/65-70	5021+5018+5590	5021+5018+5563	588	6021+6018+5590	6021+6018+5563	636
105-109/65-70	5002+5018+5590	5002+5018+5563	598	6002+6018+5590	6002+6018+5563	646
115-120/65-70	5022+5018+5590	5022+5018+5563	609	6022+6018+5590	6022+6018+5563	667
125-129/65-70	5006+5018+5591	5006+5018+5564	630	6006+6018+5591	6006+6018+5564	683
135-139/65-70	5008+5018+5591	5008+5018+5564	639	6008+6018+5591	6008+6018+5564	695
combinaciones c/ LADOS 75 fijo+corredera						
70-75/70-75	5029+5029+5590	5029+5029+5563	572	6029+6029+5590	6029+6029+5563	616
75-80/70-75	5019+5029+5590	5019+5029+5563	577	6019+6029+5590	6019+6029+5563	620
80-85/70-75	5030+5029+5590	5030+5029+5563	583	6030+6029+5590	6030+6029+5563	626
85-90/70-75	5020+5029+5590	5020+5029+5563	588	6020+6029+5590	6020+6029+5563	631
90-95/70-75	5031+5029+5590	5031+5029+5563	591	6031+6029+5590	6031+6029+5563	636
95-100/70-75	5021+5029+5590	5021+5029+5563	593	6021+6029+5590	6021+6029+5563	642
105-109/70-75	5002+5029+5590	5002+5029+5563	603	6002+6029+5590	6002+6029+5563	652
115-120/70-75	5022+5029+5590	5022+5029+5563	614	6022+6029+5590	6022+6029+5563	673
125-129/70-75	5006+5029+5591	5006+5029+5564	635	6006+6029+5591	6006+6029+5564	689
135-139/70-75	5008+5029+5591	5008+5029+5564	644	6008+6029+5591	6008+6029+5564	701
combinaciones c/ LADOS 80 fijo+corredera						
75-80/75-80	5019+5019+5590	5019+5019+5563	582	6019+6019+5590	6019+6019+5563	624
80-85/75-80	5030+5019+5590	5030+5019+5563	588	6030+6019+5590	6030+6019+5563	630
85-90/75-80	5020+5019+5590	5020+5019+5563	593	6020+6019+5590	6020+6019+5563	635
90-95/75-80	5031+5019+5590	5031+5019+5563	596	6031+6019+5590	6031+6019+5563	640
95-100/75-80	5021+5019+5590	5021+5019+5563	598	6021+6019+5590	6021+6019+5563	646
105-109/75-80	5002+5019+5590	5002+5019+5563	608	6002+6019+5590	6002+6019+5563	656
115-120/75-80	5022+5019+5590	5022+5019+5563	619	6022+6019+5590	6022+6019+5563	677
125-129/75-80	5006+5019+5591	5006+5019+5564	640	6006+6019+5591	6006+6019+5564	693
135-139/75-80	5008+5019+5591	5008+5019+5564	649	6008+6019+5591	6008+6019+5564	705
combinaciones c/ LADOS 90 fijo+corredera						
85-90/85-90	5020+5020+5590	5020+5020+5563	604	6020+6020+5590	6020+6020+5563	646
90-95/85-90	5031+5020+5590	5031+5020+5563	607	6031+6020+5590	6031+6020+5563	651
95-100/85-90	5021+5020+5590	5021+5020+5563	609	6021+6020+5590	6021+6020+5563	657
105-109/85-90	5002+5020+5590	5002+5020+5563	619	6002+6020+5590	6002+6020+5563	667
115-120/85-90	5022+5020+5590	5022+5020+5563	630	6022+6020+5590	6022+6020+5563	688
125-129/85-90	5006+5020+5591	5006+5020+5564	651	6006+6020+5591	6006+6020+5564	704
135-139/85-90	5008+5020+5591	5008+5020+5564	660	6008+6020+5591	6008+6020+5564	716

Desglose por referencias/punto en página 304. Aperturas ver página 65.

BASIC COLOR frontal + lateral fijo de 8mm



Gomas transparentes anti-coloración



Doble rodamiento regulable en nylon con antivuelco



*Juego 2 gomas verticales negras ref. 0014, 15 puntos



Guiador optimizado con pulsador liberador de hoja

PASO 1: PERFILERÍA

Descripción	● NEGRO	● BLANCO	Puntos
	Ref.	Ref.	
Accesorios frontal hasta 140 cm + kit lateral	5493+5492	5583+5588	261
Accesorios frontal hasta 180 cm + kit lateral	5494+5492	5584+5588	269

PASO 2: FRONTALES+LAT. FIJO

Medida	Rangos (cm)	TRANSPARENTE		FROST PLUS	
		Ref.	Puntos	Ref.	Puntos
combinaciones c/ LATERAL FIJO DE 70					
100x70	Cristales de 95-100/66,5-69	5001+5025	265	6001+6025	312
110x70	Cristales de 105-110/66,5-69	5003+5025	278	6003+6025	325
120x70	Cristales de 115-120/66,5-69	5005+5025	287	6005+6025	339
130x70	Cristales de 125-130/66,5-69	5007+5025	299	6007+6025	353
140x70	Cristales de 135-140/66,5-69	5009+5025	309	6009+6025	365
150x70	Cristales de 145-150/66,5-69	5011+5025	319	6011+6025	379
160x70	Cristales de 155-160/66,5-69	5013+5025	331	6013+6025	393
170x70	Cristales de 165-170/66,5-69	5015L+5025	337	6015L+6025	416
180x70	Cristales de 175-180/66,5-69	5017L+5025	349	6017L+6025	431
combinaciones c/ LATERAL FIJO DE 75					
100x75	Cristales de 95-100/71,5-74	5001+5057	270	6001+6057	317
110x75	Cristales de 105-110/71,5-74	5003+5057	283	6003+6057	330
120x75	Cristales de 115-120/71,5-74	5005+5057	292	6005+6057	344
130x75	Cristales de 125-130/71,5-74	5007+5057	304	6007+6057	358
140x75	Cristales de 135-140/71,5-74	5009+5057	314	6009+6057	370
150x75	Cristales de 145-150/71,5-74	5011+5057	324	6011+6057	384
160x75	Cristales de 155-160/71,5-74	5013+5057	336	6013+6057	398
170x75	Cristales de 165-170/71,5-74	5015L+5057	342	6015L+6057	421
180x75	Cristales de 175-180/71,5-74	5017L+5057	354	6017L+6057	436
combinaciones c/ LATERAL FIJO DE 80					
100x80	Cristales de 95-100/76,5-79	5001+5026	275	6001+6026	322
110x80	Cristales de 105-110/76,5-79	5003+5026	288	6003+6026	335
120x80	Cristales de 115-120/76,5-79	5005+5026	297	6005+6026	349
130x80	Cristales de 125-130/76,5-79	5007+5026	309	6007+6026	363
140x80	Cristales de 135-140/76,5-79	5009+5026	319	6009+6026	375
150x80	Cristales de 145-150/76,5-79	5011+5026	329	6011+6026	389
160x80	Cristales de 155-160/76,5-79	5013+5026	341	6013+6026	403
170x80	Cristales de 165-170/76,5-79	5015L+5026	347	6015L+6026	426
180x80	Cristales de 175-180/76,5-79	5017L+5026	359	6017L+6026	441
combinaciones c/ LATERAL FIJO DE 90					
100x90	Cristales de 95-100/86,5-89	5001+5027	290	6001+6027	337
110x90	Cristales de 105-110/86,5-89	5003+5027	303	6003+6027	350
120x90	Cristales de 115-120/86,5-89	5005+5027	312	6005+6027	364
130x90	Cristales de 125-130/86,5-89	5007+5027	324	6007+6027	378
140x90	Cristales de 135-140/86,5-89	5009+5027	334	6009+6027	390
150x90	Cristales de 145-150/86,5-89	5011+5027	344	6011+6027	404
160x90	Cristales de 155-160/86,5-89	5013+5027	356	6013+6027	418
170x90	Cristales de 165-170/86,5-89	5015L+5027	362	6015L+6027	441
180x90	Cristales de 175-180/86,5-89	5017L+5027	374	6017L+6027	456

*Opción perfil unión fijo-fijo +40 puntos (**indicar mano**). Referencia NEGRO: **0991** | Referencia BLANCO: **0182B**

*Otras medidas con laterales fijos de 100, 110, 120 y frontales intermedios ver pag. 304

BASIC COLOR frontal + lateral fijo de 8mm



Gomas transparentes anti-coloración



Doble rodamiento regulable en nylon con antivuelco



Perfecto acabado interior/externo



Guiador optimizado con pulsador liberador de hoja

PASO 1: PERFILERÍA

Descripción	ORO	NÍQUEL	Puntos
	Ref.	Ref.	
Accesorios frontal hasta 140 cm + kit lateral	5440+5445	5460+5469	330
Accesorios frontal hasta 180 cm + kit lateral	5441+5445	5461+5469	337

PASO 2: FRONTALES+LAT. FIJO

Medida	Rangos (cm)	TRANSPARENTE		FROST PLUS	
		Ref.	Puntos	Ref.	Puntos
combinaciones c/ LATERAL FIJO DE 70					
100x70	Cristales de 95-100/66,5-69	5001+5025	265	6001+6025	312
110x70	Cristales de 105-110/66,5-69	5003+5025	278	6003+6025	325
120x70	Cristales de 115-120/66,5-69	5005+5025	287	6005+6025	339
130x70	Cristales de 125-130/66,5-69	5007+5025	299	6007+6025	353
140x70	Cristales de 135-140/66,5-69	5009+5025	309	6009+6025	365
150x70	Cristales de 145-150/66,5-69	5011+5025	319	6011+6025	379
160x70	Cristales de 155-160/66,5-69	5013+5025	331	6013+6025	393
170x70	Cristales de 165-170/66,5-69	5015L+5025	337	6015L+6025	416
180x70	Cristales de 175-180/66,5-69	5017L+5025	349	6017L+6025	431
combinaciones c/ LATERAL FIJO DE 75					
100x75	Cristales de 95-100/71,5-74	5001+5057	270	6001+6057	317
110x75	Cristales de 105-110/71,5-74	5003+5057	283	6003+6057	330
120x75	Cristales de 115-120/71,5-74	5005+5057	292	6005+6057	344
130x75	Cristales de 125-130/71,5-74	5007+5057	304	6007+6057	358
140x75	Cristales de 135-140/71,5-74	5009+5057	314	6009+6057	370
150x75	Cristales de 145-150/71,5-74	5011+5057	324	6011+6057	384
160x75	Cristales de 155-160/71,5-74	5013+5057	336	6013+6057	398
170x75	Cristales de 165-170/71,5-74	5015L+5057	342	6015L+6057	421
180x75	Cristales de 175-180/71,5-74	5017L+5057	354	6017L+6057	436
combinaciones c/ LATERAL FIJO DE 80					
100x80	Cristales de 95-100/76,5-79	5001+5026	275	6001+6026	322
110x80	Cristales de 105-110/76,5-79	5003+5026	288	6003+6026	335
120x80	Cristales de 115-120/76,5-79	5005+5026	297	6005+6026	349
130x80	Cristales de 125-130/76,5-79	5007+5026	309	6007+6026	363
140x80	Cristales de 135-140/76,5-79	5009+5026	319	6009+6026	375
150x80	Cristales de 145-150/76,5-79	5011+5026	329	6011+6026	389
160x80	Cristales de 155-160/76,5-79	5013+5026	341	6013+6026	403
170x80	Cristales de 165-170/76,5-79	5015L+5026	347	6015L+6026	426
180x80	Cristales de 175-180/76,5-79	5017L+5026	359	6017L+6026	441
combinaciones c/ LATERAL FIJO DE 90					
100x90	Cristales de 95-100/86,5-89	5001+5027	290	6001+6027	337
110x90	Cristales de 105-110/86,5-89	5003+5027	303	6003+6027	350
120x90	Cristales de 115-120/86,5-89	5005+5027	312	6005+6027	364
130x90	Cristales de 125-130/86,5-89	5007+5027	324	6007+6027	378
140x90	Cristales de 135-140/86,5-89	5009+5027	334	6009+6027	390
150x90	Cristales de 145-150/86,5-89	5011+5027	344	6011+6027	404
160x90	Cristales de 155-160/86,5-89	5013+5027	356	6013+6027	418
170x90	Cristales de 165-170/86,5-89	5015L+5027	362	6015L+6027	441
180x90	Cristales de 175-180/86,5-89	5017L+5027	374	6017L+6027	456

*Opción perfil unión fijo-fijo +50 puntos (**indicar mano**). Referencia ORO: **0182OR** | Referencia NÍQUEL: **0182NK**

*Otras medidas con laterales fijos de 100, 110, 120 y frontales intermedios ver pag. 304

BASIC COLOR frontal + lateral fijo de 8mm



Gomas transparentes anti-coloración



Doble rodamiento regulable en nylon con antivuelco



Perfecto acabado interior/externo



Guiador optimizado con pulsador liberador de hoja

PASO 1: PERFILERÍA

Descripción	COBRE	TITANIO	Puntos
	Ref.	Ref.	
Accesorios frontal hasta 140 cm + kit lateral	5592+5597	5560+5567	330
Accesorios frontal hasta 180 cm + kit lateral	5593+5597	5561+5567	337

PASO 2: FRONTALES+LAT. FIJO

Medida	Rangos (cm)	TRANSPARENTE		FROST PLUS	
		Ref.	Puntos	Ref.	Puntos
combinaciones c/ LATERAL FIJO DE 70					
100x70	Cristales de 95-100/66,5-69	5001+5025	265	6001+6025	312
110x70	Cristales de 105-110/66,5-69	5003+5025	278	6003+6025	325
120x70	Cristales de 115-120/66,5-69	5005+5025	287	6005+6025	339
130x70	Cristales de 125-130/66,5-69	5007+5025	299	6007+6025	353
140x70	Cristales de 135-140/66,5-69	5009+5025	309	6009+6025	365
150x70	Cristales de 145-150/66,5-69	5011+5025	319	6011+6025	379
160x70	Cristales de 155-160/66,5-69	5013+5025	331	6013+6025	393
170x70	Cristales de 165-170/66,5-69	5015L+5025	337	6015L+6025	416
180x70	Cristales de 175-180/66,5-69	5017L+5025	349	6017L+6025	431
combinaciones c/ LATERAL FIJO DE 75					
100x75	Cristales de 95-100/71,5-74	5001+5057	270	6001+6057	317
110x75	Cristales de 105-110/71,5-74	5003+5057	283	6003+6057	330
120x75	Cristales de 115-120/71,5-74	5005+5057	292	6005+6057	344
130x75	Cristales de 125-130/71,5-74	5007+5057	304	6007+6057	358
140x75	Cristales de 135-140/71,5-74	5009+5057	314	6009+6057	370
150x75	Cristales de 145-150/71,5-74	5011+5057	324	6011+6057	384
160x75	Cristales de 155-160/71,5-74	5013+5057	336	6013+6057	398
170x75	Cristales de 165-170/71,5-74	5015L+5057	342	6015L+6057	421
180x75	Cristales de 175-180/71,5-74	5017L+5057	354	6017L+6057	436
combinaciones c/ LATERAL FIJO DE 80					
100x80	Cristales de 95-100/76,5-79	5001+5026	275	6001+6026	322
110x80	Cristales de 105-110/76,5-79	5003+5026	288	6003+6026	335
120x80	Cristales de 115-120/76,5-79	5005+5026	297	6005+6026	349
130x80	Cristales de 125-130/76,5-79	5007+5026	309	6007+6026	363
140x80	Cristales de 135-140/76,5-79	5009+5026	319	6009+6026	375
150x80	Cristales de 145-150/76,5-79	5011+5026	329	6011+6026	389
160x80	Cristales de 155-160/76,5-79	5013+5026	341	6013+6026	403
170x80	Cristales de 165-170/76,5-79	5015L+5026	347	6015L+6026	426
180x80	Cristales de 175-180/76,5-79	5017L+5026	359	6017L+6026	441
combinaciones c/ LATERAL FIJO DE 90					
100x90	Cristales de 95-100/86,5-89	5001+5027	290	6001+6027	337
110x90	Cristales de 105-110/86,5-89	5003+5027	303	6003+6027	350
120x90	Cristales de 115-120/86,5-89	5005+5027	312	6005+6027	364
130x90	Cristales de 125-130/86,5-89	5007+5027	324	6007+6027	378
140x90	Cristales de 135-140/86,5-89	5009+5027	334	6009+6027	390
150x90	Cristales de 145-150/86,5-89	5011+5027	344	6011+6027	404
160x90	Cristales de 155-160/86,5-89	5013+5027	356	6013+6027	418
170x90	Cristales de 165-170/86,5-89	5015L+5027	362	6015L+6027	441
180x90	Cristales de 175-180/86,5-89	5017L+5027	374	6017L+6027	456

*Opción perfil unión fijo-fijo +50 puntos (**indicar mano**). Referencia COBRE: **0182CB** | Referencia TITANIO: **0182T**

*Otras medidas con laterales fijos de 100, 110, 120 y frontales intermedios ver pag. 304

BASIC fijo + puerta + fijo



Rango = Rango Min/Max frontal + Medida fijo en línea

Configúralo a tu gusto y medida en nuestro B2B ver página 237

PASO 1: PERFILERÍA

Descripción	CROMO	NEGRO	BLANCO	Puntos
	Ref.	Ref.	Ref.	
Accesorios hasta 140 cm	5434+5467	5493+5467N	5583+5467B	215
Accesorios hasta 180 cm	5438+5467	5494+5467N	5584+5467B	223
Accesorios hasta 200 cm	5446+5467	5495+5467N	5585+5467B	240

Descripción	ORO	NÍQUEL	COBRE	TITANIO	Puntos
	Ref.	Ref.	Ref.	Ref.	
Accesorios hasta 140 cm	5440+5467OR	5460+5467NK	5592+5467CB	5560+5467T	255
Accesorios hasta 180 cm	5441+5467OR	5461+5467NK	5593+5467CB	5561+5467T	262
Accesorios hasta 200 cm	5442+5467OR	5462+5467NK	5594+5467CB	5562+5467T	275

PASO 2: FIJOS EN LÍNEA

Medida fijo	TRANSPARENTE		FROST PLUS	
	Ref.	Puntos	Ref.	Puntos
Fijo de 30 cm	5018F	65	6018F	80
Fijo de 35 cm	5019F	70	6019F	85
Fijo de 40 cm	5020F	75	6020F	90
Fijo de 45 cm	5021F	80	6021F	95
Fijo de 52 cm	5002F	90	6002F	100
Fijo de 55 cm	5022F	95	6022F	110
Fijo de 57 cm	5004F	100	6004F	115

PASO 3: FRONTALES

Descripción	Rangos (cm)	TRANSPARENTE		FROST PLUS	
		Ref.	Puntos	Ref.	Puntos
Fijo + Puerta frontal de 100	95-100	5001	145	6001	172
Fijo + Puerta frontal de 105	100-105	5002	152	6002	179
Fijo + Puerta frontal de 110	105-110	5003	158	6003	185
Fijo + Puerta frontal de 115	110-115	5004	163	6004	192
Fijo + Puerta frontal de 120	115-120	5005	167	6005	199
Fijo + Puerta frontal de 125	120-125	5006	174	6006	206
Fijo + Puerta frontal de 130	125-130	5007	179	6007	213
Fijo + Puerta frontal de 135	130-135	5008	183	6008	218
Fijo + Puerta frontal de 140	135-140	5009	189	6009	225
Fijo + Puerta frontal de 145	140-145	5010	194	6010	232
Fijo + Puerta frontal de 150	145-150	5011	199	6011	239
Fijo + Puerta frontal de 155	150-155	5012	206	6012	246
Fijo + Puerta frontal de 160	155-160	5013	211	6013	253
Fijo + Puerta frontal de 165	160-165	5014	215	6014	257
Fijo + Puerta frontal de 170	165-170	5015L	217	6015L	276
Fijo + Puerta frontal de 175	170-175	5016L	223	6016L	284
Fijo + Puerta frontal de 180	175-180	5017L	229	6017L	291
Fijo + Puerta frontal de 190	180-190	5023L	239	6023L	306
Fijo + Puerta frontal de 200	190-200	5024L	250	6024L	321

A medida y especiales, ver pag. 288

BASIC FREE Mayor paso de entrada / Menor precio / Misma Función



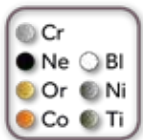
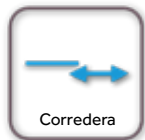
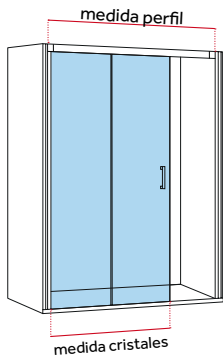

PASO 1: Seleccionar medida/color de la PERFILERÍA
PASO 2: Seleccionar medida/decorado de los CRISTALES

PASO 1: PERFILERÍA

Descripción	CROMO	NEGRO	BLANCO	Puntos
	Ref.	Ref.	Ref.	
Perf. y acc. hasta 140 + KIT FREE	5434+5447	5493+5447N	5583+5447B	191
Perf. y acc. hasta 180 + KIT FREE	5438+5447	5494+5447N	5584+5447B	199
Perf. y acc. hasta 200 + KIT FREE	5446+5447	5495+5447N	5585+5447B	216

Descripción	ORO	NÍQUEL	COBRE	TITANIO	Puntos
	Ref.	Ref.	Ref.	Ref.	
Perf. y acc. hasta 140 + KIT FREE	5440+5447OR	5460+5447NK	5592+5447CB	5560+5447T	225
Perf. y acc. hasta 180 + KIT FREE	5441+5447OR	5461+5447NK	5593+5447CB	5561+5447T	232
Perf. y acc. hasta 200 + KIT FREE	5442+5447OR	5462+5447NK	5594+5447CB	5562+5447T	245

PASO 2: CRISTALES

Rangos (cm)	TRANSPARENTE		FROST PLUS	
	Ref.	Puntos	Ref.	Puntos
Cristales de 95-100	5001	145	6001	172
Cristales de 100-105	5002	152	6002	179
Cristales de 105-110	5003	158	6003	185
Cristales de 110-115	5004	163	6004	192
Cristales de 115-120	5005	167	6005	199
Cristales de 120-125	5006	174	6006	206
Cristales de 125-130	5007	179	6007	213
Cristales de 130-135	5008	183	6008	218
Cristales de 135-140	5009	189	6009	225
Cristales de 140-145	5010	194	6010	232
Cristales de 145-150	5011	199	6011	239
Cristales de 150-155	5012	206	6012	246
Cristales de 155-160	5013	211	6013	253
Cristales de 160-165	5014	215	6014	257
Cristales de 165-170	5015L	217	6015L	276
Cristales de 170-175	5016L	223	6016L	284
Cristales de 175-180	5017L	229	6017L	291
Cristales de 180-190	5023L	239	6023L	306
Cristales de 190-200	5024L	250	6024L	321



Mamparas a medida y cristales especiales	TRANSPARENTE	FROST PLUS PARSOL / MATE	CAJONADO
	+45%	+60%	+21

*Plazo de entrega 15 días (más información en pág. 288)

BASIC FREE ANGULAR



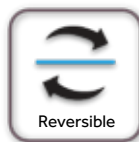
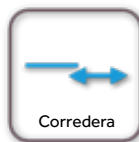

PASO 1: Seleccionar medida/color de la PERFILERÍA ANGULAR

PASO 2: Seleccionar medida/decorado de los CRISTALES

PASO 1: PERFILERÍA

Descripción	CROMO	NEGRO	BLANCO	Puntos
	Ref.	Ref.	Ref.	
Acc. hasta 120x90 cm + KIT FREE	5423+5447	5490+5447N	5580+5447B	260
Acc. hasta 140x100 cm + KIT FREE	5424+5447	5491+5447N	5581+5447B	270

Descripción	ORO	NÍQUEL	COBRE	TITANIO	Puntos
	Ref.	Ref.	Ref.	Ref.	
Acc. hasta 120x90 cm + KIT FREE	5448+5447OR	5463+5447NK	5590+5447CB	5563+5447T	345
Acc. hasta 140x100 cm + KIT FREE	5449+5447OR	5464+5447NK	5591+5447CB	5564+5447T	355

PASO 2: CRISTALES

Rangos (frontal / lado free)	TRANSPARENTE		FROST PLUS	
	Referencias	Puntos	Referencias	Puntos
65-70 / 65-100	5018	116	6018	137
70-75 / 65-100	5029	121	6029	143
75-80 / 65-100	5019	126	6019	147
80-85 / 65-100	5030	132	6030	153
85-90 / 65-100	5020	137	6020	158
90-95 / 65-100	5031	140	6031	163
95-100 / 65-100	5021	142	6021	169
105-109 / 65-100	5002	152	6002	179
115-120 / 65-100	5022	163	6022	200
125-129 / 65-100	5006	174	6006	206
135-139 / 65-100	5008	183	6008	218

*Desglose por referencias/punto en página 304.

Descripción	Referencias	Puntos
Perfil de compensación +1,5 cm cromo	5429	35
Perfil de compensación +1,5 cm negro	5477	35
Perfil de compensación +1,5 cm blanco	5473	35
Perfil de compensación +1,5 cm oro	5474	45
Perfil de compensación +1,5 cm níquel	5475	45
Perfil de compensación +1,5 cm cobre	5476	45
Perfil de compensación +1,5 cm titanio	5478	45



Mamparas a medida y cristales especiales	TRANSPARENTE	FROST PLUS PARSOL / MATE	CAJONADO
Altura hasta 195 cm	+45%	+60%	+21
Altura de 195 hasta 220 cm	+75%	+90%	+21

*Plazo de entrega 15 días (más información en pág. 288)

prestige

“Fiabilidad y prestaciones
al mejor precio”





PRESTIGE semicircular



Descripción	Rango	Apert.	TRANSPARENTE		FROST PLUS	
			Referencias	Puntos	Referencias	Puntos
80x80 RADIO ITALIANO R55	76,5-79,5	46	0011	395	0052	420
90x90 RADIO ITALIANO R55	86,5-89,5	52	0013	410	0053	435
75x75 RADIO ROCA R50	71,5-74,5	39	0044	395	-	-
80x80 RADIO ROCA R50	76,5-79,5	46	0046	395	0048	420
90x90 RADIO ROCA R50	86,5-89,5	52	0047	410	0049	435
Perfil de compensación +2 cm			0218	35		
Perfil de compensación +4 cm			0029	45		

PRESTIGE NEGRA semicircular

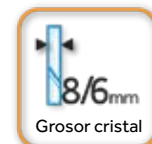

PREST/AKT

Descripción	Rango	Apertura	Ref.	Puntos
80x80 RADIO ITALIANO R55	76,5-79,5	46	0011N	395
90x90 RADIO ITALIANO R55	86,5-89,5	52	0013N	410
75x75 RADIO ROCA R50	71,5-74,5	39	0044N	395
80x80 RADIO ROCA R50	76,5-79,5	46	0046N	395
90x90 RADIO ROCA R50	86,5-89,5	52	0047N	410
Perfil de compensación +2 cm			9016	35

PRESTIGE 1 fijo+1 corredera



Descripción	Rangos	Apertura	TRANSPARENTE		FROST PLUS	
			Referencias	Puntos	Referencias	Puntos
PRESTIGE 1F+1C 100X195	97-103	38	0200	295	0272	320
PRESTIGE 1F+1C 110X195	107-113	43	0201	305	0273	335
PRESTIGE 1F+1C 120X195	117-123	48	0202	315	0274	350
PRESTIGE 1F+1C 130X195	127-133	53	0203	330	0275	365
PRESTIGE 1F+1C 140X195	137-143	58	0204	355	0276	380
PRESTIGE 1F+1C 150X195	147-153	63	0205	375	0277	400
PRESTIGE 1F+1C 160X195	157-163	58	0206	395	0278	425
PRESTIGE 1F+1C 170X195	167-173	63	0207	415	0279	450
Perfil compensación +2 cm					0218	35
Perfil compensación +4 cm					0029	45

*Se puede combinar con el lateral fijo STD (ver pág. 106), el rango aumenta en 0,7 y se pierde la expansión en el lado dónde se instala el fijo.

PRESTIGE 2 fijos+2 correderas



PREST/AKT

Descripción	Rangos	Apertura	TRANSPARENTE		FROST PLUS	
			Referencias	Puntos	Referencias	Puntos
PRESTIGE 2F+2C 140X195	136-142	53	0610	410	0616	435
PRESTIGE 2F+2C 150X195	146-152	58	0611	425	0617	460
PRESTIGE 2F+2C 160X195	156-162	63	0612	440	0618	470
PRESTIGE 2F+2C 170X195	166-172	68	0613	455	0619	480
PRESTIGE 2F+2C 180X195	176-182	73	0614	465	0620	490
PRESTIGE 2F+2C 190X195	186-192	78	0615	475	0621	500
Perfil compensación +2 cm					0218	35
Perfil compensación +4 cm					0029	45

*Se puede combinar con el lateral fijo STD (ver pág. 106), el rango aumenta en 0,7 y se pierde la expansión en el lado dónde se instala el fijo.

PRESTIGE angular al vértice



Descripción	TRANSPARENTE		FROST PLUS	
	Ref.	Puntos	Ref.	Puntos
Lado 70x195 cm PRESTIGE	0313	200	0295	220
Lado 75x195 cm PRESTIGE	0375	205	0294	225
Lado 80x195 cm PRESTIGE	0314	210	0296	230
Lado 90x195 cm PRESTIGE	0315	220	0297	245
Lado 100x195 cm PRESTIGE	0316	230	0298	255
Lado 120x195 cm PRESTIGE	0317	240	0299	270



Altura



Grosor cristal

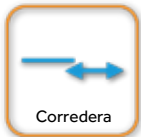

Corredera



Expansión



Magnético



aluminio
AL
aluminium



Reversible



clear shield glass

Medida	Rangos	Apert.
70x70	67-70 / 67-70	33
80x70	77-80 / 67-70	37
90x70	87-90 / 67-70	41
100x70	97-100 / 67-70	45
110x70	104-107 / 67-70	47
120x70	117-120 / 67-70	50
130x70	124-127 / 67-70	56
140x70	134-137 / 67-70	60
150x70	144-147 / 67-70	64
160x70	154-157 / 67-70	60
170x70	164-167 / 67-70	64

Medida	Rangos	Apert.
70x75	67-70 / 72-74	35
75x75	72-74 / 72-74	37
80x75	77-80 / 72-74	39
90x75	87-90 / 72-74	42
100x75	97-100 / 72-74	47
110x75	104-107 / 72-74	49
120x75	117-120 / 72-74	52
130x75	124-127 / 72-74	58
140x75	134-137 / 72-74	62
150x75	144-147 / 72-74	66
160x75	154-157 / 72-74	62
170x75	164-167 / 72-74	66

Medida	Rangos	Apert.
80x80	77-80 / 77-80	40
90x80	87-90 / 77-80	44
100x80	97-100 / 77-80	48
110x80	104-107 / 77-80	50
120x80	117-120 / 77-80	52
130x80	124-127 / 77-80	58
140x80	134-137 / 77-80	62
150x80	144-147 / 77-80	66
160x80	154-157 / 77-80	62
170x80	164-167 / 77-80	66

Medida	Rangos	Apert.
90x90	87-90 / 87-90	47
100x90	97-100 / 87-90	51
110x90	104-107 / 87-90	53
120x90	117-120 / 87-90	55
130x90	124-127 / 87-90	60
140x90	134-137 / 87-90	64
150x90	144-147 / 87-90	68
160x90	154-157 / 87-90	64
170x90	164-167 / 87-90	68

TRANSPARENTE	
Referencias	Puntos
0313 + 0313	400
0314 + 0313	410
0315 + 0313	420
0316 + 0313	430
0201 + 0313	505
0317 + 0313	440
0203 + 0313	530
0204 + 0313	555
0205 + 0313	575
0206 + 0313	595
0207 + 0313	615

Referencias	Puntos
0313 + 0375	405
0375 + 0375	410
0314 + 0375	415
0315 + 0375	425
0316 + 0375	435
0201 + 0375	510
0317 + 0375	445
0203 + 0375	535
0204 + 0375	560
0205 + 0375	580
0206 + 0375	600
0207 + 0375	620

Referencias	Puntos
0314 + 0314	420
0315 + 0314	430
0316 + 0314	440
0201 + 0314	515
0317 + 0314	450
0203 + 0314	540
0204 + 0314	565
0205 + 0314	585
0206 + 0314	605
0207 + 0314	625

Referencias	Puntos
0315 + 0315	440
0316 + 0315	450
0201 + 0315	525
0317 + 0315	460
0203 + 0315	550
0204 + 0315	575
0205 + 0315	595
0206 + 0315	615
0207 + 0315	635

FROST PLUS	
Referencias	Puntos
0295 + 0295	440
0296 + 0295	450
0297 + 0295	465
0298 + 0295	475
0273 + 0295	555
0299 + 0295	490
0275 + 0295	585
0276 + 0295	600
0277 + 0295	620
0278 + 0295	645
0279 + 0295	670

Referencias	Puntos
0295 + 0294	445
0294 + 0294	450
0296 + 0294	455
0297 + 0294	470
0298 + 0294	480
0273 + 0294	560
0299 + 0294	495
0275 + 0294	590
0276 + 0294	605
0277 + 0294	625
0278 + 0294	650
0279 + 0294	675

Referencias	Puntos
0296 + 0296	460
0297 + 0296	475
0298 + 0296	485
0273 + 0296	565
0299 + 0296	500
0275 + 0296	595
0276 + 0296	610
0277 + 0296	630
0278 + 0296	655
0279 + 0296	680

Referencias	Puntos
0297 + 0297	490
0298 + 0297	500
0273 + 0297	580
0299 + 0297	515
0275 + 0297	610
0276 + 0297	625
0277 + 0297	645
0278 + 0297	670
0279 + 0297	695

También se pueden obtener combinaciones con lados de 100 y 120

Descripción	Referencias	Puntos
Perfil compensación +2 cm	0218	35
Perfil compensación +4 cm	0029	45

PRESTIGE frontal + lateral fijo 8 mm



Descripción	Rangos (min-max)	Referencias	Puntos
Lateral fijo STD 8 mm 30x195	26-29	0810	155
Lateral fijo STD 8 mm 40x195	36-39	0811	165
Lateral fijo STD 8 mm 50x195	46-49	0812	175
Lateral fijo STD 8 mm 60x195	56-59	0813	185
Lateral fijo STD 8 mm 70x195	66-69	0814	195
Lateral fijo STD 8 mm 75x195	71-74	0820	200
Lateral fijo STD 8 mm 80x195	76-79	0815	205
Lateral fijo STD 8 mm 90x195	86-89	0816	220
Lateral fijo STD 8 mm FROST PLUS 70	66-69	0817	230
Lateral fijo STD 8 mm FROST PLUS 80	76-79	0818	240
Lateral fijo STD 8 mm FROST PLUS 90	86-89	0819	250



H195

Altura



8/6mm

Grosor cristal

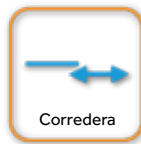

Corredera



3cm

Expansión



Magnético



Reversible



aluminio
AL
aluminium



Tratamiento antirreflexivo
clear shield glass

PRESTIGE + lateral fijo de 8 mm



cierre imán oculto



rodamiento rfzdo. doble



pulsador liberador

Medidas	Rangos	Apert.	TRANSPARENTE		FROST PLUS	
			Referencias	Puntos	Referencias	Puntos
100x70	97,4-100,4 / 66-69	38	0200 + 0814	490	0272 + 0817	550
110x70	107,4-110,4 / 66-69	43	0201 + 0814	500	0273 + 0817	565
120x70	117,4-120,4 / 66-69	48	0202 + 0814	510	0274 + 0817	580
130x70	127,4-130,4 / 66-69	53	0203 + 0814	525	0275 + 0817	595
140x70	137,4-140,4 / 66-69	58	0204 + 0814	550	0276 + 0817	610
150x70	147,4-150,4 / 66-69	53	0205 + 0814	570	0277 + 0817	630
160x70	157,4-160,4 / 66-69	58	0206 + 0814	590	0278 + 0817	655
170x70	167,4-170,4 / 66-69	63	0207 + 0814	610	0279 + 0817	680
Medidas	Rangos	Apert.	Referencias	Puntos	Referencias	Puntos
100x80	97,4-100,4 / 76-79	38	0200 + 0815	500	0272 + 0818	560
110x80	107,4-110,4 / 76-79	43	0201 + 0815	510	0273 + 0818	575
120x80	117,4-120,4 / 76-79	48	0202 + 0815	520	0274 + 0818	590
130x80	127,4-130,4 / 76-79	53	0203 + 0815	535	0275 + 0818	605
140x80	137,4-140,4 / 76-79	58	0204 + 0815	560	0276 + 0818	620
150x80	147,4-150,4 / 76-79	53	0205 + 0815	580	0277 + 0818	640
160x80	157,4-160,4 / 76-79	58	0206 + 0815	600	0278 + 0818	665
170x80	167,4-170,4 / 76-79	63	0207 + 0815	620	0279 + 0818	690
Medidas	Rangos	Apert.	Referencias	Puntos	Referencias	Puntos
100x90	97,4-100,4 / 86-89	38	0200 + 0816	515	0272 + 0819	570
110x90	107,4-110,4 / 86-89	43	0201 + 0816	525	0273 + 0819	585
120x90	117,4-120,4 / 86-89	48	0202 + 0816	535	0274 + 0819	600
130x90	127,4-130,4 / 86-89	53	0203 + 0816	550	0275 + 0819	615
140x90	137,4-140,4 / 86-89	58	0204 + 0816	575	0276 + 0819	630
150x90	147,4-150,4 / 86-89	53	0205 + 0816	595	0277 + 0819	650
160x90	157,4-160,4 / 86-89	58	0206 + 0816	615	0278 + 0819	675
170x90	167,4-170,4 / 86-89	63	0207 + 0816	635	0279 + 0819	700

*Se pueden hacer otras combinaciones con medidas intermedias de frontales

Descripción	Referencias	Puntos
Perfil compensación +2 cm	0218	35
Perfil compensación +4 cm	0029	45
Perfil compensación (+ 5,5 cm)	0219	45



Descripción	TRANSPARENTE		FROST PLUS		Cajonado
	Ref.	P	Ref.	P	
Lateral fijo a medida hasta 40 cm	1343	175	1343+1312	297	+21
Lateral fijo a medida 40 hasta 80 cm	1304	250	1304+1313	372	+21
Lateral fijo a medida 80 hasta 120 cm	1310	320	1310+1315	442	+21

*Plazo de entrega 15 días (más información en página 290)

aktual

“Evolución y prestaciones
Prestige sin perflería
inferior”





AKTUAL 1 fijo+1 corredera



Descripción	Rangos	Apertura	TRANSPARENTE		FROST PLUS	
			Referencias	Puntos	Referencias	Puntos
AKTUAL 1F+1C 100X195	97-103	38	0280	310	0580	350
AKTUAL 1F+1C 110X195	107-113	43	0281	320	0581	360
AKTUAL 1F+1C 120X195	117-123	48	0282	335	0582	370
AKTUAL 1F+1C 130X195	127-133	53	0283	360	0583	400
AKTUAL 1F+1C 140X195	137-143	58	0284	385	0584	425
AKTUAL 1F+1C 150X195	147-153	63	0285	400	0585	445
AKTUAL 1F+1C 160X195	157-163	58	0286	415	0586	455
AKTUAL 1F+1C 170X195	167-173	63	0287	435	0587	480
Perfil compensación +2 cm					0218	35
Perfil compensación +4 cm					0029	45

*Se puede combinar con el lateral fijo STD (ver pág. 114), el rango aumenta en 0,7 y se pierde la expansión en el lado dónde se instala el fijo.

AKTUAL 2 fijos+2 correderas

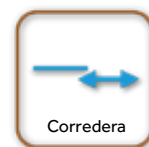

PREST/AKT

Descripción	Rangos	Apertura	TRANSPARENTE		FROST PLUS	
			Referencias	Puntos	Referencias	Puntos
AKTUAL 2F+2C 140X195	136-142	53	0570	410	0588	460
AKTUAL 2F+2C 150X195	146-152	58	0571	425	0589	485
AKTUAL 2F+2C 160X195	156-162	63	0572	440	0590	505
AKTUAL 2F+2C 170X195	166-172	68	0573	455	0591	530
AKTUAL 2F+2C 180X195	176-182	73	0574	470	0592	545
AKTUAL 2F+2C 190X195	186-192	78	0575	485	0593	565
Perfil compensación +2 cm					0218	35
Perfil compensación +4 cm					0029	45

*Se puede combinar con el lateral fijo STD (ver pág. 114), el rango aumenta en 0,7 y se pierde la expansión en el lado dónde se instala el fijo.

AKTUAL angular al vértice



Descripción	TRANSPARENTE		FROST PLUS	
	Ref.	Puntos	Ref.	Puntos
Lado 70x195 AKTUAL 1 fijo+1 corredera	0320	215	0595	245
Lado 80x195 AKTUAL 1 fijo+1 corredera	0321	230	0596	260
Lado 90x195 AKTUAL 1 fijo+1 corredera	0322	240	0597	275
Lado 100x195 AKTUAL 1 fijo+1 corredera	0323	250	0598	290
Lado 120x195 AKTUAL 1 fijo+1 corredera	0324	260	0599	310



H195

Altura



8/6mm

Grosor cristal

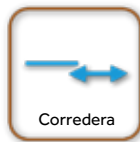

Corredera



3cm

Expansión



Magnético



Reversible



aluminio
AL
aluminium



Antical
CLEAR
SHIELD
GLASS

combinaciones angular **AKTUAL** apertura al vértice



Tirador doble asa



Doble rodamiento antivuelco



Vierteaguas metálico

Medida	Rangos	Apert.
70x70	67-70 / 67-70	33
80x70	77-80 / 67-70	37
90x70	87-90 / 67-70	41
100x70	97-100 / 67-70	45
110x70	104-107 / 67-70	47
120x70	117-120 / 67-70	50
130x70	124-127 / 67-70	56
140x70	134-137 / 67-70	60
150x70	144-147 / 67-70	64

Medida	Rangos	Apert.
80x80	77-80 / 77-80	40
90x80	87-90 / 77-80	44
100x80	97-100 / 77-80	48
110x80	104-107 / 77-80	50
120x80	117-120 / 77-80	52
130x80	124-127 / 77-80	58
140x80	134-137 / 77-80	62
150x80	144-147 / 77-80	66

Medida	Rangos	Apert.
90x90	87-90 / 87-90	47
100x90	97-100 / 87-90	51
110x90	104-107 / 87-90	53
120x90	117-120 / 87-90	55
130x90	124-127 / 87-90	60
140x90	134-137 / 87-90	64
150x90	144-147 / 87-90	68

TRANSPARENTE		FROST PLUS	
Referencias	Puntos	Referencias	Puntos
0320 + 0320	430	0595 + 0595	490
0321 + 0320	445	0596 + 0595	505
0322 + 0320	455	0597 + 0595	520
0323 + 0320	465	0598 + 0595	535
0281 + 0320	535	0581 + 0595	605
0324 + 0320	475	0599 + 0595	555
0283 + 0320	575	0583 + 0595	645
0284 + 0320	600	0584 + 0595	670
0285 + 0320	615	0585 + 0595	690
Referencias	Puntos	Referencias	Puntos
0321 + 0321	460	0596 + 0596	520
0322 + 0321	470	0597 + 0596	535
0323 + 0321	480	0598 + 0596	550
0281 + 0321	550	0581 + 0596	620
0324 + 0321	490	0599 + 0596	570
0283 + 0321	590	0583 + 0596	660
0284 + 0321	615	0584 + 0596	685
0285 + 0321	630	0585 + 0596	705
Referencias	Puntos	Referencias	Puntos
0322 + 0322	480	0597 + 0597	550
0323 + 0322	490	0598 + 0597	565
0281 + 0322	560	0581 + 0597	635
0324 + 0322	500	0599 + 0597	585
0283 + 0322	575	0583 + 0597	675
0284 + 0322	625	0584 + 0597	700
0285 + 0322	640	0585 + 0597	720

También se pueden obtener combinaciones con lados de 100 y 120

Descripción	Referencia	Puntos
Perfil compensación +2 cm	0218	35
Perfil compensación +4 cm	0029	45

AKTUAL frontal + lateral fijo STD 8 mm



Descripción	Rangos (min-max)	Referencias	Puntos
Lateral fijo STD 8 mm 30	26-29	0810	155
Lateral fijo STD 8 mm 40	36-39	0811	165
Lateral fijo STD 8 mm 50	46-49	0812	175
Lateral fijo STD 8 mm 60	56-59	0813	185
Lateral fijo STD 8 mm 70	66-69	0814	195
Lateral fijo STD 8 mm 75	71-74	0820	200
Lateral fijo STD 8 mm 80	76-79	0815	205
Lateral fijo STD 8 mm 90	86-89	0816	220
Lateral fijo STD 8 mm FROST PLUS 70	66-69	0817	230
Lateral fijo STD 8 mm FROST PLUS 80	76-79	0818	240
Lateral fijo STD 8 mm FROST PLUS 90	86-89	0819	250



H195

Altura



8/6mm

Grosor cristal

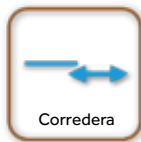

Corredera



3cm

Expansión



Magnético



Reversible



aluminio
AL
aluminium



tratamiento antical
clear shield glass



Cierre imán oculto



Doble rodamiento antivuelco



Vierteaguas metálico

AKTUAL + lateral fijo de 8 mm

Medidas	Rangos	Apert.	TRANSPARENTE		FROST PLUS	
			Referencias	Puntos	Referencias	Puntos
100x70	97,4-100,4 / 66-69	38	0280 + 0814	505	0580 + 0817	580
110x70	107,4-110,4 / 66-69	43	0281 + 0814	515	0581 + 0817	590
120x70	117,4-120,4 / 66-69	48	0282 + 0814	530	0582 + 0817	600
130x70	127,4-130,4 / 66-69	53	0283 + 0814	555	0583 + 0817	630
140x70	137,4-140,4 / 66-69	58	0284 + 0814	580	0584 + 0817	655
150x70	147,4-150,4 / 66-69	53	0285 + 0814	595	0585 + 0817	675
160x70	157,4-160,4 / 66-69	58	0286 + 0814	610	0586 + 0817	685
170x70	167,4-170,4 / 66-69	63	0287 + 0814	630	0587 + 0817	710
Medidas	Rangos	Apert.	Referencias	Puntos	Referencias	Puntos
100x80	97,4-100,4 / 76-79	38	0280 + 0815	515	0580 + 0818	590
110x80	107,4-110,4 / 76-79	43	0281 + 0815	525	0581 + 0818	600
120x80	117,4-120,4 / 76-79	48	0282 + 0815	540	0582 + 0818	610
130x80	127,4-130,4 / 76-79	53	0283 + 0815	565	0583 + 0818	640
140x80	137,4-140,4 / 76-79	58	0284 + 0815	590	0584 + 0818	665
150x80	147,4-150,4 / 76-79	53	0285 + 0815	605	0585 + 0818	685
160x80	157,4-160,4 / 76-79	58	0286 + 0815	620	0586 + 0818	695
170x80	167,4-170,4 / 76-79	63	0287 + 0815	640	0587 + 0818	720
Medidas	Rangos	Apert.	Referencias	Puntos	Referencias	Puntos
100x90	97,4-100,4 / 86-89	38	0280 + 0816	530	0580 + 0819	600
110x90	107,4-110,4 / 86-89	43	0281 + 0816	540	0581 + 0819	610
120x90	117,4-120,4 / 86-89	48	0282 + 0816	555	0582 + 0819	620
130x90	127,4-130,4 / 86-89	53	0283 + 0816	580	0583 + 0819	650
140x90	137,4-140,4 / 86-89	58	0284 + 0816	605	0584 + 0819	675
150x90	147,4-150,4 / 86-89	53	0285 + 0816	620	0585 + 0819	695
160x90	157,4-160,4 / 86-89	58	0286 + 0816	635	0586 + 0819	705
170x90	167,4-170,4 / 86-89	63	0287 + 0816	655	0587 + 0819	730

*Se pueden hacer otras combinaciones con medidas intermedias de frontales

Descripción	Referencias	Puntos
Perfil compensación +2 cm	0218	35
Perfil compensación +4 cm	0029	45
Perfil compensación + 5,5 cm	0219	45



Descripción	Laterales fijos a medida AKTUAL		TRANSPARENTE		FROST PLUS	
	Ref.	Puntos	Ref.	Puntos	Ref.	Puntos
Lateral fijo a medida hasta 40 cm	1343	175	1343+1312	297	297	+21
Lateral fijo a medida de 40 hasta 80 cm	1304	250	1304+1313	372	372	+21
Lateral fijo a medida de 80 hasta 120 cm	1310	320	1310+1315	442	442	+21

*Plazo de entrega 15 días. Más información en página 290.

GME

VETRUM pg.119



TEMPLE pg.129



FUTURA pg.133

MOVING pg.137

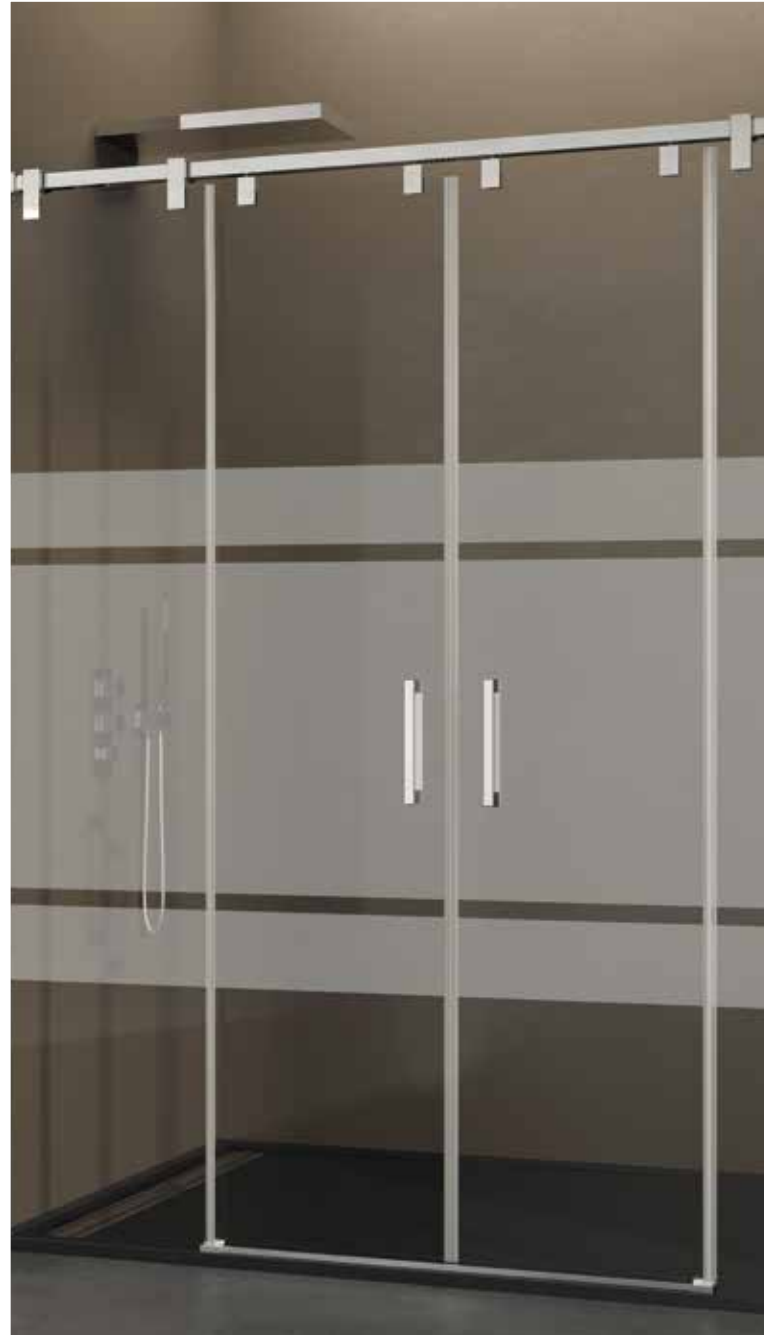

ACERO

**MAMPARAS
ACERO
CORREDERAS**

vetrum

10/8mm

“Diseño y calidades
insuperables con ausencia
total de perflería”





ACERO

VETRUM 1 fijo + 1 corredera



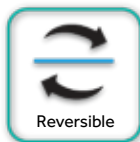
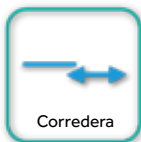

Frontales VETRUM 1 fijo+1 corredera

Descripción	Rango	Apertura	Referencias	Puntos
Frontal ducha 1F+1C VETRUM 115	113-118	39,7-44,3	1070	771
Frontal ducha 1F+1C VETRUM 120	117-122	40,7-45,7	1050	779
Frontal ducha 1F+1C VETRUM 125	122-127	40,7-45,7	1051	807
Frontal ducha 1F+1C VETRUM 130	127-132	45,7-50,7	1052	825
Frontal ducha 1F+1C VETRUM 135	132-137	45,7-50,7	1053	848
Frontal ducha 1F+1C VETRUM 140	137-142	50,7-55,7	1054	861
Frontal ducha 1F+1C VETRUM 145	142-147	50,7-55,7	1055	867
Frontal ducha 1F+1C VETRUM 150	147-152	55,7-60,7	1056	875
Frontal ducha 1F+1C VETRUM 155	152-157	55,7-60,7	1057	887
Frontal ducha 1F+1C VETRUM 160	157-162	60,7-65,7	1058	895
Frontal ducha 1F+1C VETRUM 165	162-167	60,7-65,7	1059	907
Frontal ducha 1F+1C VETRUM 170	167-172	65,7-70,7	1060	915
Frontal ducha 1F+1C VETRUM 175	172-177	60,7-65,7	1061	940
Frontal ducha 1F+1C VETRUM 180	177-182	65,7-70,7	1062	948
Perfil expansión +1 cm			1073	64
Opción barra inox paralela hasta 2 m			5546	65
Opción cierre perfil inox + burbuja *Con este sistema el rango se reduce 2 cm			1072	65



Guía y rodamiento inferior en acero



Rodamiento acero integrado



Opción barra paralela



VETRUM FREE 1 fijo + 1 corredera

Descripción	Referencias	Puntos
Freno vetrum free	1071	17

En el formato Free el rango se reduce en 2 cm

VETRUM 2 fijos + 2 correderas



Descripción	Referencias	Puntos
Kit conversión 2f+2c	1071	17



Frontales VETRUM 2F + 2C

Descripción	Rango	Apertura	Referencias	Puntos
VETRUM 2F + 2C 150	134-154	30-50	1067+1067+1071	1185
VETRUM 2F + 2C 170	154-174	40-60	1068+1068+1071	1247
VETRUM 2F + 2C 190	174-194	50-70	1069+1069+1071	1351
VETRUM 2F + 2C 210	213-233	69-89	1070+1070+1071	1559
Perfil expansión +1 cm			1073	64



Guía y rodamiento inferior en acero



Rodamiento acero integrado



Barra acero ext. 108 cm y orientable

VETRUM angular al vértice



Descripción	Referencias	Puntos
lado VETRUM 70 1 fijo+1 corredera	1066	554
lado VETRUM 80 1 fijo+1 corredera	1067	584
lado VETRUM 90 1 fijo+1 corredera	1068	615
lado VETRUM 100 1 fijo+1 corredera	1069	667
lado VETRUM 120 1 fijo+1 corredera	1070	771

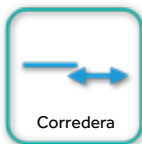
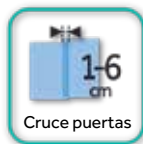

Combinaciones angular **VETRUM** apertura al vértice

Medidas	Rangos	Apertura	Referencias	Puntos
90x70	85-90/65-70	33-36	1068+1066	1169
100x70	95-100/65-70	37-40	1069+1066	1221
115x70	114-119/65-70	44-49	1070+1066	1325
120x70	118-123/65-70	44-49	1050+1066	1333
125x70	123-128/65-70	45-50	1051+1066	1361
130x70	128-133/65-70	49-54	1052+1066	1379
135x70	133-138/65-70	49-54	1053+1066	1402
140x70	138-143/65-70	55-60	1054+1066	1415
145x70	143-148/65-70	55-60	1055+1066	1421
150x70	148-153/65-70	59-64	1056+1066	1429
Medidas	Rangos	Apertura	Referencias	Puntos
80x80	75-80/75-80	33-36	1067+1067	1168
90x80	85-90/75-80	36-39	1068+1067	1199
100x80	95-100/75-80	40-43	1069+1067	1251
115x80	114-119/75-80	46-51	1070+1067	1355
120x80	118-123/75-80	46-51	1050+1067	1363
125x80	123-128/75-80	47-52	1051+1067	1391
130x80	128-133/75-80	51-56	1052+1067	1409
135x80	133-138/75-80	51-56	1053+1067	1432
140x80	138-143/75-80	56-61	1054+1067	1445
145x80	143-148/75-80	56-61	1055+1067	1451
150x80	148-153/75-80	60-65	1056+1067	1459
Medidas	Rangos	Apertura	Referencias	Puntos
90x90	85-90/85-90	40-43	1068+1068	1230
100x90	95-100/85-90	43-46	1069+1068	1282
115x90	114-119/85-90	51-54	1070+1068	1386
120x90	118-123/85-90	51-54	1050+1068	1394
125x90	123-128/85-90	50-55	1051+1068	1422
130x90	128-133/85-90	54-59	1052+1068	1440
135x90	133-138/85-90	54-59	1053+1068	1463
140x90	138-143/85-90	58-63	1054+1068	1476
145x90	143-148/85-90	58-63	1055+1068	1482
150x90	148-153/85-90	63-68	1056+1068	1490
Perfil expansión +1 cm			1073	64

VETRUM frontal + lateral fijo



Descripción	Rango	Referencias	Puntos
Lateral fijo 70 VETRUM 10 mm + brazo	67-69	1063	348
Lateral fijo 75 VETRUM 10 mm + brazo	72-74	1115	358
Lateral fijo 80 VETRUM 10 mm + brazo	77-79	1064	367
Lateral fijo 90 VETRUM 10 mm + brazo	87-89	1065	386

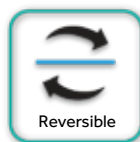
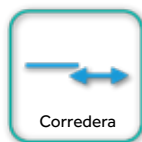
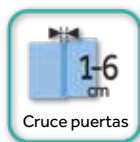

Combinaciones VETRUM frontal + lateral fijo

Medidas	Rango	Referencias	Puntos	Medidas	Rango	Referencias	Puntos
115x70	113-117 / 67-69	1070 +1063	1119	115x75	113-117 / 72-74	1070 + 1115	1129
120x70	116-121 / 67-69	1050 +1063	1127	120x75	116-121 / 72-74	1050 + 1115	1137
125x70	121-126 / 67-69	1051 +1063	1155	125x75	121-126 / 72-74	1051 + 1115	1165
130x70	126-131 / 67-69	1052 +1063	1173	130x75	126-131 / 72-74	1052 + 1115	1183
135x70	131-136 / 67-69	1053 +1063	1196	135x75	131-136 / 72-74	1053 + 1115	1206
140x70	136-141 / 67-69	1054 +1063	1209	140x75	136-141 / 72-74	1054 + 1115	1219
145x70	141-146 / 67-69	1055 +1063	1215	145x75	141-146 / 72-74	1055 + 1115	1225
150x70	146-151 / 67-69	1056 +1063	1223	150x75	146-151 / 72-74	1056 + 1115	1233
155x70	151-156 / 67-69	1057 +1063	1235	155x75	151-156 / 72-74	1057 + 1115	1245
160x70	156-161 / 67-69	1058 +1063	1243	160x75	156-161 / 72-74	1058 + 1115	1253
165x70	161-166 / 67-69	1059 +1063	1255	165x75	161-166 / 72-74	1059 + 1115	1265
170x70	166-171 / 67-69	1060 +1063	1263	170x75	166-171 / 72-74	1060 + 1115	1273
175x70	171-176 / 67-69	1061 +1063	1288	175x75	171-176 / 72-74	1061 + 1115	1298
180x70	176-181 / 67-69	1062 +1063	1296	180x75	176-181 / 72-74	1062 + 1115	1306
115x80	113-117 / 77-79	1070 + 1064	1138	115x90	113-117 / 87-89	1070 + 1065	1157
120x80	116-121 / 77-79	1050 +1064	1146	120x90	116-121 / 87-89	1050 +1065	1165
125x80	121-126 / 77-79	1051 +1064	1174	125x90	121-126 / 87-89	1051 +1065	1193
130x80	126-131 / 77-79	1052 +1064	1192	130x90	126-131 / 87-89	1052 +1065	1211
135x80	131-136 / 77-79	1053 +1064	1215	135x90	131-136 / 87-89	1053 +1065	1234
140x80	136-141 / 77-79	1054 +1064	1228	140x90	136-141 / 87-89	1054 +1065	1247
145x80	141-146 / 77-79	1055 +1064	1234	145x90	141-146 / 87-89	1055 +1065	1253
150x80	146-151 / 77-79	1056 +1064	1242	150x90	146-151 / 87-89	1056 +1065	1261
155x80	151-156 / 77-79	1057 +1064	1254	155x90	151-156 / 87-89	1057 +1065	1273
160x80	156-161 / 77-79	1058 +1064	1262	160x90	156-161 / 87-89	1058 +1065	1281
165x80	161-166 / 77-79	1059 +1064	1274	165x90	161-166 / 87-89	1059 +1065	1293
170x80	166-171 / 77-79	1060 +1064	1282	170x90	166-171 / 87-89	1060 +1065	1301
175x80	171-176 / 77-79	1061 +1064	1307	175x90	171-176 / 87-89	1061 +1065	1326
180x80	176-181 / 77-79	1062 +1064	1315	180x90	176-181 / 87-89	1062 +1065	1334
1073	perfil expansión +1 cm		64				

*Las aperturas son las mismas que en los frontales.

Laterales fijos a medida (más información en página 290)



Descripción	Referencias	Puntos	Cajonado
Lateral fijo a medida VETRUM hasta 40 cm	1340	305	+21
Lateral fijo a medida VETRUM de 40 hasta 80 cm	1300	390	+21
Lateral fijo a medida VETRUM de 80 hasta 120 cm	1306	460	+21
Opción perfil unión fijo + lateral fijo (ver pág. 295)	1075	82	

*Plazo de entrega 15 días

temple

“La nobleza y resistencia del
acero al alcance de todos”





ACERO



TEMPLE

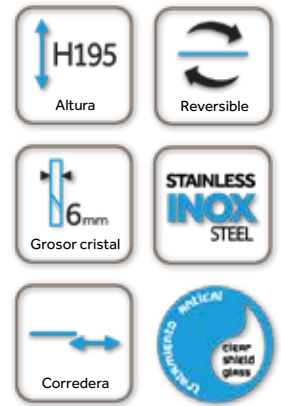

Embellecedores. Perfectos acabados externos e internos



Doble rodamiento última generación nylon



Innovador guiador con pulsador liberador de hoja para facilitar la limpieza



Perfilería de acero inoxidable con guía interna en aluminio



MAMPARAS A MEDIDA Y CRISTALES ESPECIALES
Plazo de entrega 15 días
(más información pág. 288)

LATERALES FIJOS A MEDIDA
Plazo de entrega 15 días
(más información pág. 290)

Descripción	TRANSPARENTE		FROST PLUS	
	Ref.	Puntos	Ref.	Puntos
Lado TEMPLE 70 1 fijo+1 corredera	5118	305	6118	326
Lado TEMPLE 75 1 fijo+1 corredera	5129	312	6129	334
Lado TEMPLE 80 1 fijo+1 corredera	5119	317	6119	338
Lado TEMPLE 90 1 fijo+1 corredera	5120	331	6120	352
Lado TEMPLE 100 1 fijo+1 corredera	5121	338	6121	365
Lado TEMPLE 120 1 fijo+1 corredera	5122	361	6122	398
Corner kit unión lado + lado	5123	41		
Corner kit unión frontal + lado	5124	26		

TEMPLE apertura al vértice

Medida	Rangos	TRANSPARENTE		FROST PLUS	
		Referencias	Puntos	Referencias	Puntos
70x70	65-70 / 65-70	5118+5118+5123	651	6118+6118+5123	693
75x70	70-75 / 65-70	5129+5118+5123	658	6129+6118+5123	701
80x70	75-80 / 65-70	5119+5118+5123	663	6119+6118+5123	705
90x70	85-90 / 65-70	5120+5118+5123	677	6120+6118+5123	719
100x70	95-100 / 65-70	5121+5118+5123	684	6121+6118+5123	732
120x70	115-120 / 65-70	5122+5118+5123	707	6122+6118+5123	765
75x80	70-75 / 75-80	5119+5129+5123	670	6119+6129+5123	713
80x80	75-80 / 75-80	5119+5119+5123	675	6119+6119+5123	717
90x80	85-90 / 75-80	5120+5119+5123	689	6120+6119+5123	731
100x80	95-100 / 75-80	5121+5119+5123	696	6121+6119+5123	744
120x80	115-120 / 75-80	5122+5119+5123	719	6122+6119+5123	777
90x90	85-90 / 85-90	5120+5120+5123	703	6120+6120+5123	745
100x90	95-100 / 85-90	5121+5120+5123	710	6121+6120+5123	758
120x90	115-120 / 85-90	5122+5120+5123	733	6122+6120+5123	791



Frontales TEMPLE 1 fijo+1 corredera

Medida	TRANSPARENTE		FROST PLUS	
	Ref.	Puntos	Ref.	Puntos
95-100	5101	428	6101	455
100-105	5102	440	6102	467
105-110	5103	446	6103	473
110-115	5104	457	6104	486
115-120	5105	461	6105	493
120-125	5106	473	6106	505
125-130	5107	478	6107	512
130-135	5108	487	6108	522
135-140	5109	493	6109	529
140-145	5110	503	6110	541
145-150	5111	508	6111	548
150-155	5112	521	6112	561
155-160	5113	526	6113	568
160-165	5114	535	6114	577
165-170	5115	537	6115	596
*170-180	5117	554	6117	616

*Las aperturas son las mismas que en las combinaciones modelo Basic pag. 61

Descripción	Ref.	Puntos
Perfil de compensación +1,5 cm	5179	40
Pletina embellecedora 193,7x3,4 cm	0008	41

Laterales fijos TEMPLE

Rango	TRANSPARENTE		FROST PLUS	
	Ref.	Puntos	Ref.	Puntos
66,5-69	5125	201	6125	221
71,5-74	5157	206	6157	226
76,5-79	5126	211	6126	231
86,5-89	5127	226	6127	246

Combinaciones TEMPLE + lateral fijo

Rangos	TRANSPARENTE		FROST PLUS	
	Ref.	Puntos	Ref.	Puntos
95-100/66,5-69	5101+5125	629	6101+6125	676
105-110/66,5-69	5103+5125	647	6103+6125	694
115-120/66,5-69	5105+5125	662	6105+6125	714
125-130/66,5-69	5107+5125	679	6107+6125	733
135-140/66,5-69	5109+5125	694	6109+6125	750
145-150/66,5-69	5111+5125	709	6111+6125	769
155-160/66,5-69	5113+5125	727	6113+6125	789
165-170/66,5-69	5115+5125	738	6115+6125	817
170-180/66,5-69	5117+5125	755	6117+6125	837
95-100/76,5-79	5101+5126	639	6101+6126	686
105-110/76,5-79	5103+5126	657	6103+6126	704
115-120/76,5-79	5105+5126	672	6105+6126	724
125-130/76,5-79	5107+5126	689	6107+6126	743
135-140/76,5-79	5109+5126	704	6109+6126	760
145-150/76,5-79	5111+5126	719	6111+6126	779
155-160/76,5-79	5113+5126	737	6113+6126	799
165-170/76,5-79	5115+5126	748	6115+6126	827
170-180/76,5-79	5117+5126	765	6117+6126	847
Opción perfil de unión fijo - fijo			1075	65

Se pueden hacer otras combinaciones con medidas intermedias de frontales

*Cruce de puertas 1-11 cm

futura

“Combinación de barra de
acero y rodamientos ocultos
con estilo propio”





ACERO

FUTURA



frontales 1 fijo + 1 corredera FUTURA

Rango	TRANSPARENTE		FROST PLUS	
	Ref.	Puntos	Ref.	Puntos
95-100	5301	445	6301	472
100-105	5302	452	6302	479
105-110	5303	458	6303	485
110-115	5304	463	6304	492
115-120	5305	467	6305	499
120-125	5306	474	6306	506
125-130	5307	479	6307	513
130-135	5308	483	6308	518
135-140	5309	489	6309	525
140-145	5310	504	6310	542
145-150	5311	509	6311	549
150-155	5312	516	6312	556
155-160	5313	521	6313	563
160-165	5314	525	6314	567
165-170	5315	527	6315	586
170-175	5316	533	6316	594
175-180	5317	539	6317	601

Descripción	Ref.	Puntos
perfil de compensación +1,5 cm	5179	40
pletina embellecedora 193,7x3,4 cm	0008	41



frontales 2 fijos + 2 correderas FUTURA

Rangos	TRANSPARENTE		FROST PLUS	
	Ref.	P	Ref.	P
132-142	5029x2+5351	672	6029x2+5351	716
142-152	5019x2+5351	682	6019x2+5351	724
152-162	5030x2+5351	694	6030x2+5351	736
162-172	5020x2+5351	704	6020x2+5351	746
172-182	5031x2+5354	720	6031x2+5354	766
182-192	5021x2+5354	724	6021x2+5354	778
190-200	5001x2+5354	730	6001x2+5354	784
200-210	5002x2+5354	744	6002x2+5354	798

*Las aperturas son las mismas que en las combinaciones modelo Basic pag. 61



Perfilería y accesorios en acero inoxidable



MAMPARAS A MEDIDA Y CRISTALES ESPECIALES
Plazo de entrega 15 días
(más información pág. 288)

LATERALES FIJOS A MEDIDA
Plazo de entrega 15 días
(más información pág. 290)



ACERO

lados FUTURA	TRANSPARENTE		FROST PLUS	
	Ref.	Puntos	Ref.	Puntos
lado FUTURA 70	5018	116	6018	137
lado FUTURA 75	5029	121	6029	143
lado FUTURA 80	5019	126	6019	147
lado FUTURA 90	5020	137	6020	158
lado FUTURA 100	5021	142	6021	169
lado FUTURA 120	5022	163	6022	200
kit al vértice 120x90	5323	475		

FUTURA apertura al vértice

Rangos	TRANSPARENTE		FROST PLUS	
	Ref.	P	Ref.	P
65-70/65-70	5018+5018+5323	707	6018+6018+5323	749
70-75/65-70	5029+5018+5323	712	6029+6018+5323	755
75-80/65-70	5019+5018+5323	717	6019+6018+5323	759
85-90/65-70	5020+5018+5323	723	6020+6018+5323	765
95-100/65-70	5021+5018+5323	728	6021+6018+5323	770
115-120/65-70	5022+5018+5323	754	6022+6018+5323	812
75-80/75-80	5019+5019+5323	727	6019+6019+5323	769
85-90/75-80	5020+5019+5323	738	6020+6019+5323	780
95-100/75-80	5021+5019+5323	743	6021+6019+5323	791
115-120/75-80	5022+5019+5323	764	6022+6019+5323	822
85-90/85-90	5020+5020+5323	749	6020+6020+5323	791
95-100/85-90	5021+5020+5323	754	6021+6020+5323	802
115-120/85-90	5022+5020+5323	775	6022+6020+5323	833

laterales fijos FUTURA 8 mm

Rango	TRANSPARENTE		FROST PLUS	
	Ref.	Puntos	Ref.	Puntos
66,5 - 69	5325	255	6325	275
71,5 - 74	5357	260	6357	280
76,5 - 79	5326	265	6326	285
86,5 - 89	5327	280	6327	300

combinaciones FUTURA + lateral fijo

Rangos	TRANSPARENTE		FROST PLUS	
	Ref.	Puntos	Ref.	Puntos
95-100/66,5-69	5301+5325	700	6301+6325	747
105-110/66,5-69	5303+5325	713	6303+6325	760
115-120/66,5-69	5305+5325	722	6305+6325	774
125-130/66,5-69	5307+5325	734	6307+6325	788
135-140/66,5-69	5309+5325	744	6309+6325	800
145-150/66,5-69	5311+5325	764	6311+6325	824
155-160/66,5-69	5313+5325	776	6313+6325	838
165-170/66,5-69	5315+5325	782	6315+6325	861
175-180/66,5-69	5317+5325	794	6317+6325	876
95-100/76,5-79	5301+5326	710	6301+6326	757
105-110/76,5-79	5303+5326	723	6303+6326	770
115-120/76,5-79	5305+5326	732	6305+6326	784
125-130/76,5-79	5307+5326	744	6307+6326	798
135-140/76,5-79	5309+5326	754	6309+6326	810
145-150/76,5-79	5311+5326	774	6311+6326	834
155-160/76,5-79	5313+5326	786	6313+6326	848
165-170/76,5-79	5315+5326	792	6315+6326	871
175-180/76,5-79	5317+5326	804	6317+6326	886

Otras combinaciones con medidas intermedias de frontales y con fijos de 75/90 usar su referencia/rango/Puntos.

moving 8mm

“Diseño clásico y elegante
en acero para los más
exigentes”





ACERO



perfilería acero



guía y vierteaguas acero



barra y herrajes acero

Frontales MOVING 1 fijo + 1 corredera

Descripción	Apert.	Rango	Ref.	Puntos
Frontal MOVING 1F+1C 115	42-47	112 - 117	1104	691
Frontal MOVING 1F+1C 120	47-52	117 - 122	1005	697
Frontal MOVING 1F+1C 125	52-57	122 - 127	1105	723
Frontal MOVING 1F+1C 130	47-52	127 - 132	1006	756
Frontal MOVING 1F+1C 135	52-57	132 - 137	1106	782
Frontal MOVING 1F+1C 140	57-62	137 - 142	1007	798
Frontal MOVING 1F+1C 145	52-57	142 - 147	1107	817
Frontal MOVING 1F+1C 150	57-62	147 - 152	1008	833
Frontal MOVING 1F+1C 155	57-62	152 - 157	1108	852
Frontal MOVING 1F+1C 160	62-67	157 - 162	1009	860
Frontal MOVING 1F+1C 165	67-72	162 - 167	1109	881
Frontal MOVING 1F+1C 170	62-67	167 - 172	1010	887
Frontal MOVING 1F+1C 175	67-72	172 - 177	1110	908
Frontal MOVING 1F+1C 180	67-72	177 - 182	1011	936
Perfil expansión (+1cm)			1074	62
Opción cierre perfil + junta burbuja, con este sistema el rango se reduce 2cm			1072	65



ACERO

Lados MOVING

Descripción	Referencias	Puntos
Lado MOVING 80 1F+1C	1001	483
Lado MOVING 90 1F+1C	1002	540
Lado MOVING 120 1F+1C	1104	691
Kit conversión en angular	1017	38

Laterales fijos MOVING

Descripción	Rango	Ref.	Puntos
Lateral fijo MOVING 70	67 - 69	1015	332
Lateral fijo MOVING 80	77 - 79	1016	345

Combinaciones MOVING apertura al vértice

Medidas	Ap.	Rangos	Referencias	Puntos
80x80	41 - 43	76-80/76-80	1001+1001+1017	1004
90x80	45 - 47	86-90/76-80	1002+1001+1017	1061
120x80	52 - 54	116-122/76-80	1104+1001+1017	1212
130x80	60 - 62	124-129/76-80	1105+1001+1017	1244
140x80	60 - 62	134-139/76-80	1106+1001+1017	1303
90x90	48 - 50	86-90/86-90	1002+1002+1017	1118
120x90	55 - 57	116-122/86-90	1104+1002+1017	1269
130x90	63 - 65	124-129/86-90	1105+1002+1017	1301
140x90	63 - 65	134-139/86-90	1106+1002+1017	1360
Perfil expansión +1cm			1074	62

Combinaciones MOVING + lateral fijo 8 mm

Medidas	Rangos	Referencias	Puntos	
120X70	116-120/67-69	1005+1015	1029	
130X70	126-130/67-69	1006+1015	1088	
140X70	136-140/67-69	1007+1015	1130	
150X70	146-150/67-69	1008+1015	1165	
160X70	156-160/67-69	1009+1015	1192	
170X70	166-170/67-69	1010+1015	1219	
180X70	176-180/67-69	1011+1015	1268	
120X80	116-120/77-79	1005+1016	1042	
130X80	126-130/77-79	1006+1016	1101	
140X80	136-140/77-79	1007+1016	1143	
150X80	146-150/77-79	1008+1016	1178	
160X80	156-160/77-79	1009+1016	1205	
170X80	166-170/77-79	1010+1016	1232	
180x80	176-180/77-79	1011+1016	1281	
Perfil expansión +1cm			1074	62

*También se pueden combinar los frontales con medidas intermedias.

*El rango aumenta 2cm con respecto al formato frontal

screen

8mm

"Sencillez y belleza con amplitud de opciones y colores"

- 143 CROMO
- 145 NEGRO
- 147 BLANCO
- 149 ORO
- 151 COBRE
- 153 NÍQUEL
- 155 TITANIO
- 157 BLACK CHESS





SCREEN

SC90CR



Descripción	TRANSPARENTE		FROST PLUS	
	Ref.	Puntos	Ref.	Puntos
Screen Cromo de 66,5-68 cm + brazo soporte	SC70CR	204	SC70FCR	224
Screen Cromo de 76,5-78 cm + brazo soporte	SC80CR	214	SC80FCR	234
Screen Cromo de 86,5-88 cm + brazo soporte	SC90CR	229	SC90FCR	249
Screen Cromo de 96,5-98 cm + brazo soporte	SC100CR	244	SC100FCR	264
Screen Cromo de 106,5-108 cm + brazo soporte	SC110CR	259	SC110FCR	279
Screen Cromo de 116,5-118 cm + brazo soporte	SC120CR	274	SC120FCR	294

*Incluye brazo orientable/ajustable 60-120 cm (ref. 0184). Opción barra paralela ver pag. 159

SCREEN A MEDIDA (ver pag. 292)

Descripción	TRANSPARENTE		FROST PLUS	
	Ref.	Puntos	Ref.	Puntos
Ancho < 80 cm Altura hasta 195 cm	1305	333	1305+1313	455
Ancho de 80 a 120 cm Altura hasta 195 cm	1311	407	1311+1315	529

Plazo de entrega 15 días. Incluye cristal a medida y kit perfil + brazo.

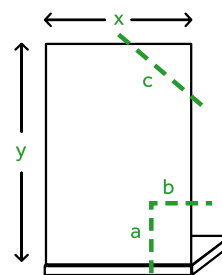

**CORTE ESCUADRA/CAJONADO
PARA CRISTAL A MEDIDA**

Ref.: 0862 | Puntos: 21

SCREEN MOVING

SC90FCR+0193



H195
Altura

8mm
Grosor cristal

Reversible

STAINLESS
INOX
STEEL

Tratamiento Antical

clear shield glass

● Cr ● Ni
● Ne ● Bl
● Or ● Co ● Ti

Descripción	TRANSPARENTE		FROST PLUS	
	Ref.	Puntos	Ref.	Puntos
Móvil 25 cm	0153	124	0193	140
Móvil 40 cm	0154	147	0194	162

Los cristales móviles aumentan 24,5 / 39,5 cm la medida del fijo

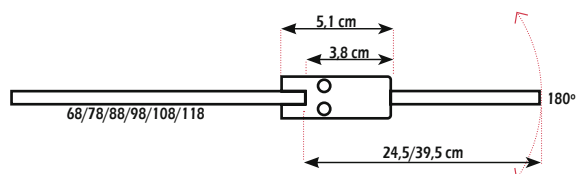

FIJOS

SCREEN 35 BISAGRA 180°

SC90CR+0331



Bisagra latón cromado

Descripción	TRANSPARENTE		FROST PLUS	
	Ref.	Puntos	Ref.	Puntos
Abatible 35 cm	0331	145	0332CR	187

*Abatibles a medida (ver página 293).

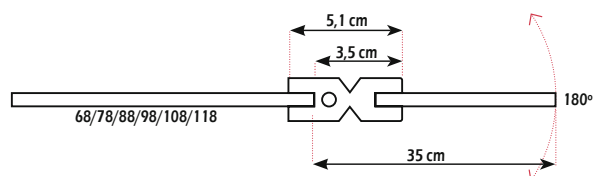

SCREEN NEGRA



Descripción	TRANSPARENTE		FROST PLUS	
	Ref.	Puntos	Ref.	Puntos
Screen negra de 66,5-68 cm + brazo soporte negro	SC70N	204	SC70FN	224
Screen negra de 76,5-78 cm + brazo soporte negro	SC80N	214	SC80FN	234
Screen negra de 86,5-88 cm + brazo soporte negro	SC90N	229	SC90FN	249
Screen negra de 96,5-98 cm + brazo soporte negro	SC100N	244	SC100FN	264
Screen negra de 106,5-108 cm + brazo soporte negro	SC110N	259	SC110FN	279
Screen negra de 116,5-118 cm + brazo soporte negro	SC120N	274	SC120FN	294

*Incluye brazo orientable/ajustable 60-120 cm (ref. 0990). Opción barra paralela ver pag. 159

SCREEN NEGRA A MEDIDA (ver pag. 292)

Descripción	TRANSPARENTE		FROST PLUS	
	Ref.	Puntos	Ref.	Puntos
Ancho < 80 cm Altura hasta 195 cm	1305N	333	1305N+1313	455
Ancho de 80 a 120 cm Altura hasta 195 cm	1311N	407	1311N+1315	529

Plazo de entrega 15 días

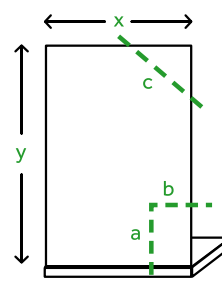

CORTE ESCUADRA/CAJONADO PARA CRISTAL A MEDIDA

Ref.: 0862 | Puntos: 21

SCREEN NEGRA móvil bisagra 180°



FIJOS

Descripción	TRANSPARENTE		FROST PLUS	
	Ref.	Puntos	Ref.	Puntos
Cristal móvil de 35 cm	0331N	145	0332N	187

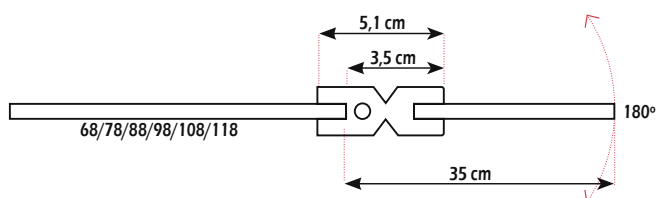

MÓVIL BISAGRAS NEGRO A MEDIDA (ver pag. 293)

Medida	TRANSPARENTE		FROST PLUS	
	Ref.	Puntos	Ref.	Puntos
Ancho < 40 cm Altura hasta 195 cm	1355N	206	1357N	328
Ancho de 40 a 80 cm Altura hasta 195 cm	1356N	271	1358N	393

Plazo de entrega 15 días

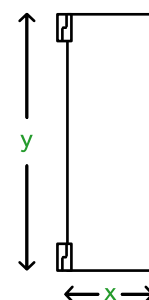

SCREEN BLANCA

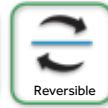

Descripción	TRANSPARENTE		FROST PLUS	
	Ref.	Puntos	Ref.	Puntos
Screen blanca de 66,5-68 cm + brazo soporte blanco	SC70B	204	SC70FB	224
Screen blanca de 76,5-78 cm + brazo soporte blanco	SC80B	214	SC80FB	234
Screen blanca de 86,5-88 cm + brazo soporte blanco	SC90B	229	SC90FB	249
Screen blanca de 96,5-98 cm + brazo soporte blanco	SC100B	244	SC100FB	264
Screen blanca de 106,5-108 cm + brazo soporte blanco	SC110B	259	SC110FB	279
Screen blanca de 116,5-118 cm + brazo soporte blanco	SC120B	274	SC120FB	294

*Incluye brazo orientable/ajustable 60-120 cm (ref. 0186)

SCREEN BLANCA A MEDIDA (ver pag. 292)

Descripción	TRANSPARENTE		FROST PLUS	
	Ref.	Puntos	Ref.	Puntos
Ancho < 80 cm Altura hasta 195 cm	1305B	333	1305B+1313	455
Ancho de 80 a 120 cm Altura hasta 195 cm	1311B	407	1311B+1315	529

Plazo de entrega 15 días

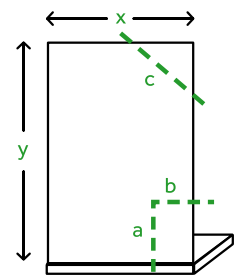

CORTE ESCUADRA/CAJONADO PARA CRISTAL A MEDIDA

Ref.: 0862 | Puntos: 21

SCREEN BLANCA móvil bisagra 180°



FIJOS

Descripción	TRANSPARENTE		FROST PLUS	
	Ref.	Puntos	Ref.	Puntos
móvil de 35 cm	0331BL	145	0332BL	187

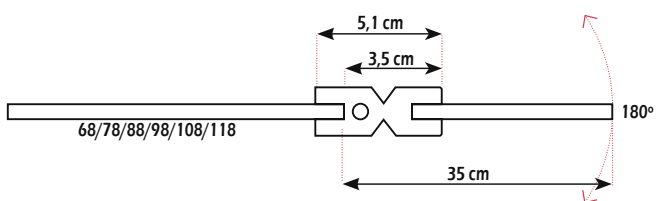

MÓVIL BISAGRAS BLANCO A MEDIDA (ver pag. 293)

Medida	TRANSPARENTE		FROST PLUS	
	Ref.	Puntos	Ref.	Puntos
Ancho < 40 cm Altura hasta 195 cm	1355B	206	1357B	328
Ancho de 40 a 80 cm Altura hasta 195 cm	1356B	271	1358B	393

Plazo de entrega 15 días

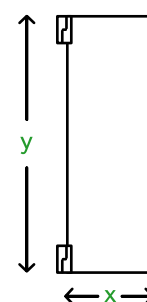

SCREEN ORO

Oro cepillado



Descripción	TRANSPARENTE		FROST PLUS	
	Ref.	Puntos	Ref.	Puntos
Screen oro de 66,5-68 cm + brazo soporte oro	SC70OR	226	SC70FOR	246
Screen oro de 76,5-78 cm + brazo soporte oro	SC80OR	236	SC80FOR	256
Screen oro de 86,5-88 cm + brazo soporte oro	SC90OR	251	SC90FOR	271
Screen oro de 96,5-98 cm + brazo soporte oro	SC100OR	266	SC100FOR	286
Screen oro de 106,5-108 cm + brazo soporte oro	SC110OR	281	SC110FOR	301
Screen oro de 116,5-118 cm + brazo soporte oro	SC120OR	296	SC120FOR	316

*Incluye brazo orientable/ajustable 60-120 cm (ref.0187)

SCREEN ORO A MEDIDA (ver pag. 292)

Descripción	TRANSPARENTE		FROST PLUS	
	Ref.	Puntos	Ref.	Puntos
Ancho < 80 cm Altura hasta 195 cm	1305OR	355	1305OR+1313	477
Ancho de 80 a 120 cm Altura hasta 195 cm	1311OR	429	1311OR+1315	551

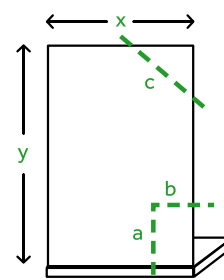

CORTE ESCUADRA/CAJONADO PARA CRISTAL A MEDIDA

Ref.: 0862 | Puntos: 21

Plazo de entrega 15 días

SCREEN ORO móvil bisagra 180°

Oro cepillado



FIJOS

Descripción	TRANSPARENTE		FROST PLUS	
	Ref.	Puntos	Ref.	Puntos
Cristal móvil de 35 cm	0331OR	155	0332OR	200

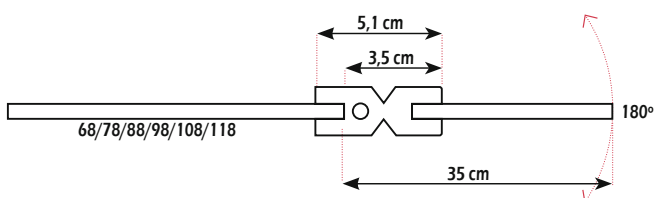

MÓVIL BISAGRAS ORO A MEDIDA (ver pag. 293)

Medida	TRANSPARENTE		FROST PLUS	
	Ref.	Puntos	Ref.	Puntos
Ancho < 40 cm Altura hasta 195 cm	1355OR	219	1357OR	341
Ancho de 40 a 80 cm Altura hasta 195 cm	1356OR	284	1358OR	406

Plazo de entrega 15 días

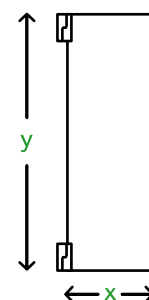

SCREEN COBRE



H195

Altura



8mm

Grosor cristal



Reversible



STAINLESS
INOX
STEEL



Cr Ni
Co Or Ti



Clear shield glass



Descripción	TRANSPARENTE		FROST PLUS	
	Ref.	Puntos	Ref.	Puntos
Screen cobre de 66,5-68 cm + brazo soporte	SC70CB	226	SC70FCB	246
Screen cobre de 76,5-78 cm + brazo soporte	SC80CB	236	SC80FCB	256
Screen cobre de 86,5-88 cm + brazo soporte	SC90CB	251	SC90FCB	271
Screen cobre de 96,5-98 cm + brazo soporte	SC100CB	266	SC100FCB	286
Screen cobre de 106,5-108 cm + brazo soporte	SC110CB	281	SC110FCB	301
Screen cobre de 116,5-118 cm + brazo soporte	SC120CB	296	SC120FCB	316

*Incluye brazo orientable/ajustable 60-120 cm (ref. 0189)

SCREEN COBRE A MEDIDA (ver pag. 292)

Descripción	TRANSPARENTE		FROST PLUS	
	Ref.	Puntos	Ref.	Puntos
Ancho < 80 cm Altura hasta 195 cm	1305CB	355	1305CB+1313	477
Ancho de 80 a 120 cm Altura hasta 195 cm	1311CB	429	1311CB+1315	551

Plazo de entrega 15 días

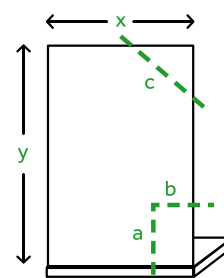

CORTE ESCUADRA/CAJONADO PARA CRISTAL A MEDIDA

Ref.: 0862 | Puntos: 21

SCREEN COBRE móvil bisagra 180°



FIJOS

Descripción	TRANSPARENTE		FROST PLUS	
	Ref.	Puntos	Ref.	Puntos
móvil de 35 cm	0331CB	155	0332CB	200

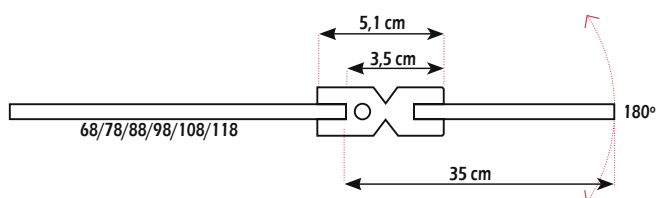

MÓVIL BISAGRAS COBRE A MEDIDA (ver pag. 293)

Medida	TRANSPARENTE		FROST PLUS	
	Ref.	Puntos	Ref.	Puntos
Ancho < 40 cm Altura hasta 195 cm	1355CB	219	1357CB	341
Ancho de 40 a 80 cm Altura hasta 195 cm	1356CB	284	1358CB	406

Plazo de entrega 15 días

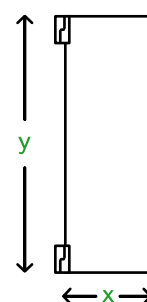

SCREEN NÍQUEL



H195

Altura



8mm

Grosor cristal



Reversible



STAINLESS
INOX
STEEL



Cr Ni
Co Or Ti



Clear shield glass



Descripción	TRANSPARENTE		FROST PLUS	
	Ref.	Puntos	Ref.	Puntos
Screen níquel de 66,5-68 cm + brazo soporte	SC70NK	226	SC70FNK	246
Screen níquel de 76,5-78 cm + brazo soporte	SC80NK	236	SC80FNK	256
Screen níquel de 86,5-88 cm + brazo soporte	SC90NK	251	SC90FNK	271
Screen níquel de 96,5-98 cm + brazo soporte	SC100NK	266	SC100FNK	286
Screen níquel de 106,5-108 cm + brazo soporte	SC110NK	281	SC110FNK	301
Screen níquel de 116,5-118 cm + brazo soporte	SC120NK	296	SC120FNK	316

*Incluye brazo orientable/ajustable 60-120 cm (ref. 0191)

SCREEN NÍQUEL A MEDIDA (ver pag. 292)

Descripción	TRANSPARENTE		FROST PLUS	
	Ref.	Puntos	Ref.	Puntos
Ancho < 80 cm Altura hasta 195 cm	1305NK	355	1305NK+1313	477
Ancho de 80 a 120 cm Altura hasta 195 cm	1311NK	429	1311NK+1315	551

Plazo de entrega 15 días

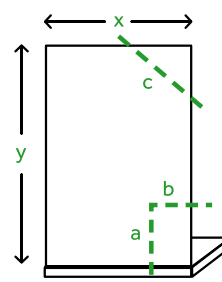

CORTE ESCUADRA/CAJONADO PARA CRISTAL A MEDIDA

Ref.: 0862 | Puntos: 21

SCREEN NÍQUEL móvil bisagra 180°

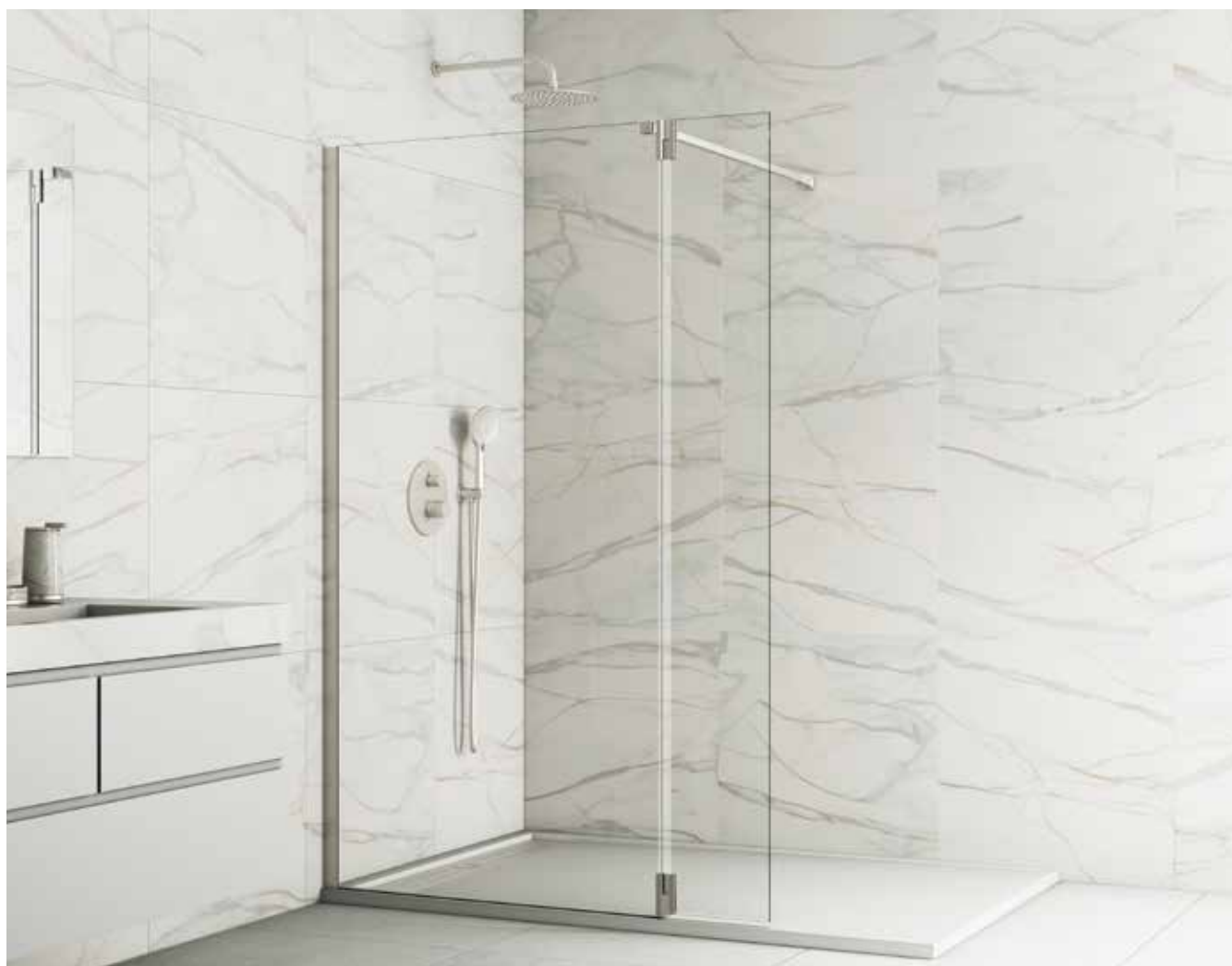

FIJOS

Descripción	TRANSPARENTE		FROST PLUS	
	Ref.	Puntos	Ref.	Puntos
móvil de 35 cm	0331NK	155	0332NK	200

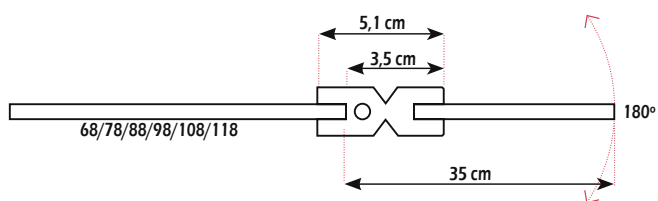

MÓVIL BISAGRAS NÍQUEL A MEDIDA (ver pag. 293)

Medida	TRANSPARENTE		FROST PLUS	
	Ref.	Puntos	Ref.	Puntos
Ancho < 40 cm Altura hasta 195 cm	1355NK	219	1357NK	341
Ancho de 40 a 80 cm Altura hasta 195 cm	1356NK	284	1358NK	406

Plazo de entrega 15 días

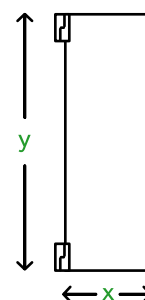

SCREEN TITANIO



Descripción	TRANSPARENTE		FROST PLUS	
	Ref.	Puntos	Ref.	Puntos
Screen titanio de 66,5-68 cm + brazo soporte	SC70T	226	SC70FT	246
Screen titanio de 76,5-78 cm + brazo soporte	SC80T	236	SC80FT	256
Screen titanio de 86,5-88 cm + brazo soporte	SC90T	251	SC90FT	271
Screen titanio de 96,5-98 cm + brazo soporte	SC100T	266	SC100FT	286
Screen titanio de 106,5-108 cm + brazo soporte	SC110T	281	SC110FT	301
Screen titanio de 116,5-118 cm + brazo soporte	SC120T	296	SC120FT	316

***Incluye brazo orientable/ajustable 60-120 cm (ref. 0190)**

SCREEN TITANIO A MEDIDA (ver pag. 292)

Descripción	TRANSPARENTE		FROST PLUS	
	Ref.	Puntos	Ref.	Puntos
Ancho < 80 cm Altura hasta 195 cm	1305T	355	1305T+1313	477
Ancho de 80 a 120 cm Altura hasta 195 cm	1311T	429	1311T+1315	551

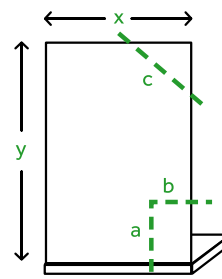

CORTE ESCUADRA/CAJONADO PARA CRISTAL A MEDIDA

Ref.: 0862 | Puntos: 21

Plazo de entrega 15 días

SCREEN TITANIO móvil bisagra 180°



FIJOS

	TRANSPARENTE		FROST PLUS	
Descripción	Ref.	Puntos	Ref.	Puntos
móvil de 35 cm	0331T	155	0332T	200

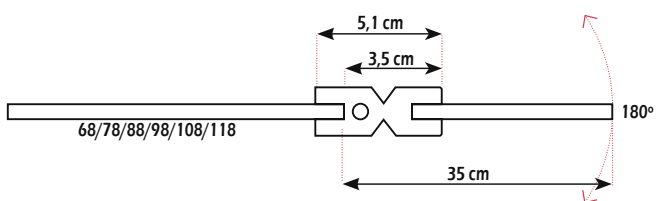

MÓVIL BISAGRAS TITANIO A MEDIDA (ver pag. 293)

	TRANSPARENTE		FROST PLUS	
Medida	Ref.	Puntos	Ref.	Puntos
Ancho < 40 cm Altura hasta 195 cm	1355CB	219	1357CB	341
Ancho de 40 a 80 cm Altura hasta 195 cm	1356CB	284	1358CB	406

Plazo de entrega 15 días

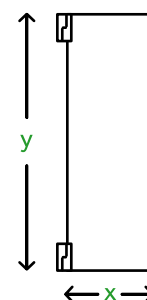

SCREEN BLACK CHESS

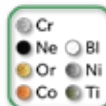

combinación con referencias 0983+0990



referencias 0983+0986+0990



Opción rodapie negro 2 m

Medida	Rango	Ref.	Puntos
Chess 70x195 + brazo soporte	67-69,5	0980+0990	280
Chess 80x195 + brazo soporte	77-79,5	0981+0990	302
Chess 90x195 + brazo soporte	87-89,5	0982+0990	320
Chess 100x195 + brazo soporte	97-99,5	0983+0990	342
Chess 110x195 + brazo soporte	107-109,5	0984+0990	365
Chess 120x195 + brazo soporte	117-119,5	0985+0990	400
Abatible de 35x195 cm, instalación derecha		0986	179
Abatible de 35x195 cm, instalación izquierda		0987	179



Ref.	Puntos
0993	25

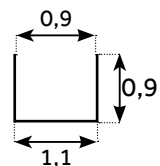

SCREEN BLACK CHESS XXL

combinación con referencias 2x0980+0990+0992



Utiliza el nuevo perfil unión ref. 0992 para unir cualquiera de las referencias de fijos Screen NEGRA Chess y conseguir medidas superiores a 120 cm.

Descripción	Ref.	Puntos
Perfil unión negro para 2 cristales fijos	0992	35

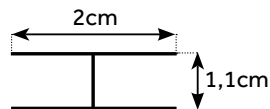

FIJOS

referencias
0980+0983+0991+0990



BLACK CHESS ANGULAR

Descripción	Referencia	Puntos
Perfil negro en ángulo	0991	40

*Aumenta 1,3 cm en uno de los lados

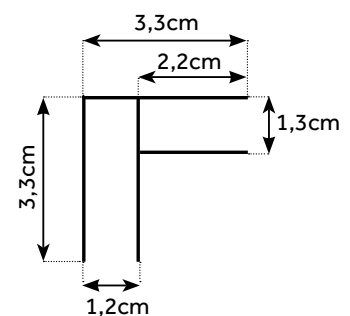

Brazos Screen / Open / Glass

barra con 1 soporte + soporte lateral fijo



soporte sujeción a pared



soporte sujeción a fijo

Descripción	CROMO	NEGRO	BLANCO	Puntos	
Barra hasta 140 cm con un soporte (frontal)	1716	9026	1716BL	44	
Barra 140 un soporte + soporte lat. fijo	1716+1718	9026+9028	1716BL+1718BL	60	
Descripción	ORO	COBRE	NÍQUEL	TITANIO	Puntos
Barra hasta 140 cm con un soporte (frontal)	1716OR	1716CB	1716NK	1716T	60
Barra 140 un soporte + soporte lat. fijo	1716OR+1718OR	1716CB+1718CB	1716NK+1718NK	1716T+1718T	80

barra cobre con 2 soportes



soporte sujeción a lateral fijo ref.1718

Descripción	CROMO	NEGRO	BLANCO	Puntos	
Barra 200 cm con un soporte (frontal)	1717	9027	1717BL	60	
Barra 200 un soporte + soporte lat. fijo	1717+1718	9027+9028	1717BL+1718BL	76	
Descripción	ORO	COBRE	NÍQUEL	TITANIO	Puntos
Barra 200 cm con un soporte (frontal)	1717OR	1717CB	1717NK	1717T	80
Barra 200 un soporte + soporte lat. fijo	1717OR+1718OR	1717CB+1718CB	1717NK+1718NK	1717T+1718T	100

Brazo 60-120 cm recto/45°



CROMO	NEGRO	BLANCO	Puntos	
0184	0990	0186	40	
ORO	COBRE	NÍQUEL	TITANIO	Puntos
0187	0189	0191	0190	55

Perfil en ángulo

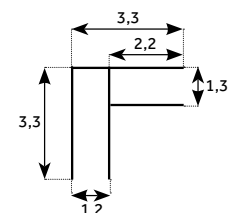

CROMO	NEGRO	BLANCO	Puntos	
0182	0991	0182BL	40	
ORO	COBRE	NÍQUEL	TITANIO	Puntos
0182OR	0182CB	0182NK	0182T	50

*Aumenta 1,3 cm en uno de los lados



Descripción	CROMO	NEGRO	P
Corner minimal 20x40 cm	1719	1719N	40



Descripción	Ref.	P
Colgador GME	0012	8



Descripción	Ref.	P
Mastil a techo Screen	0188	62

Altura máxima 260 cm



Descripción	Ref.	P
Barra apertura al vértice GLASS/OPEN	1716x2+1730	103

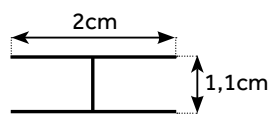

Descripción	Ref.	Puntos
Perfil unión para 2 fijos cromo	0180	33
Perfil unión para 2 fijos negro	0992	35

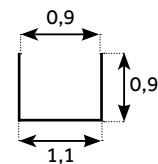

Descripción	Ref.	Puntos
Opción rodapie aluminio 2 m	0994	25
Opción rodapie negro 2 m	0993	25

open

“Programa modular de fijos
y abatibles que se adaptan a
cualquier espacio”

● CROMO

● NEGRO





ABATIBLE

OPEN COMBI A puerta con cierre imán a pared





COMBI A

Rango (cm)	Apertura	CROMO	NEGRO	Puntos
40,1-41,6	33	OP40AR	-	251
41,1-42,6	33	OP40A	-	251
45,1-46,6	38	OP45AR	-	257
46,1-47,6	38	OP45A	-	257
50,1-51,6	43	OP50AR	OP50ANR	265
51,1-52,6	43	OP50A	OP50AN	265
55,1-56,6	48	OP55AR	OP55ANR	274
56,1-57,6	48	OP55A	OP55AN	274
60,1-61,6	53	OP60AR	OP60ANR	282
61,1-62,6	53	OP60A	OP60AN	282
65,1-66,6	58	OP65AR	OP65ANR	287
66,1-67,6	58	OP65A	OP65AN	287
70,1-71,6	63	OP70AR	OP70ANR	295
71,1-72,6	63	OP70A	OP70AN	295
75,1-76,6	68	OP75AR	OP75ANR	309
76,1-77,6	68	OP75A	OP75AN	309
80,1-81,6	73	OP80AR	OP80ANR	314
81,1-82,6	73	OP80A	OP80AN	314
85,1-86,6	78	OP85AR	OP85ANR	324
86,1-87,6	78	OP85A	OP85AN	324

*Permite unión con laterales fijos STD en el lado de la puerta usando Ref. 1222/9015 (rango mínimo +1,8 cm), ver pág. 295
Las referencias acabadas en R usan el perfil ref. 1215/9014, el resto usan la ref. 1211/9012

Descripción	CROMO	NEGRO	Puntos
Perfil expansor puerta (+1,5 a +3 cm)	1222	9015	48
Juego gomas imán expansión +1,2 cm	1221		24
Juego gomas apertura IN-OUT 180°	1213		38

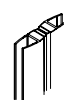
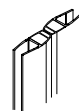

Opción 180°

ABATIBLE

OPEN COMBI A + lat. fijo

Apertura exterior
90° p/fijo



Opción in-out
0180° p/fijo



El rango del frontal aumenta 1,4 cm y
el rango del lateral fijo se reduce 1 cm
Ref. 0038 - Incremento 21 puntos

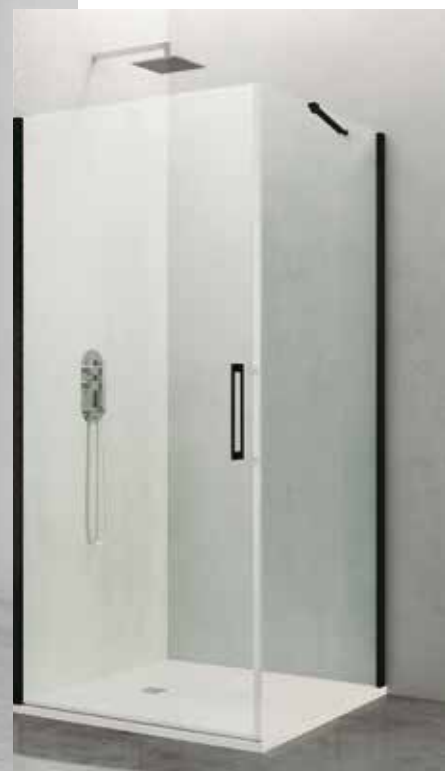

Opciones accesorios

Descripción	CROMO	NEGRO	Puntos
Perfil expansor +1,5 a +3 cm para puerta abatible	1222	9015	48
Perfil compensación +2 cm para lateral fijo	0218	9016	35
Perfil compensación +4 cm para lateral fijo	0029	-	45



Laterales fijos a medida 6 mm

Descripción	Ref.	Puntos	Cajonado
Lateral fijo a medida hasta 40 cm	1345	207	+21
Lateral fijo a medida de 40 hasta 80 cm	1316	282	+21
Lateral fijo a medida de 80 hasta 120 cm	1317	352	+21

*Plazo de entrega 15 días. Más información ver pag. 291

PASO 1 - Selección medida frontal (puerta)

Rango (cm)	Apertura	CROMO	NEGRO	Puntos
39,6-41,1	43	OP40AR	-	251
40,6-42,1	43	OP40A	-	251
44,6-46,1	43	OP45AR	-	257
45,6-47,1	48	OP45A	-	257
49,6-51,1	43	OP50AR	OP50ANR	265
50,6-52,1	58	OP50A	OP50AN	265
54,6-56,1	63	OP55AR	OP55ANR	274
55,6-57,1	43	OP55A	OP55AN	274
59,6-61,1	58	OP60AR	OP60ANR	282
60,6-62,1	73	OP60A	OP60AN	282
64,6-66,1	63	OP65AR	OP65ANR	287
65,6-67,1	43	OP65A	OP65AN	287
69,6-71,1	58	OP70AR	OP70ANR	295
70,6-72,1	73	OP70A	OP70AN	295
74,6-76,1	63	OP75AR	OP75ANR	309
75,6-77,1	58	OP75A	OP75AN	309
79,6-81,1	73	OP80AR	OP80ANR	314
80,6-82,1	63	OP80A	OP80AN	314
84,6-86,1	78	OP85AR	OP85ANR	324
85,6-87,1	73	OP85A	OP85AN	324

*Permite unión con laterales fijos STD en el lado de la puerta usando Ref. 1222/9015 (rango mínimo +1,8 cm), ver pág. 198
Las referencias acabadas en R usan el perfil ref. 1215/9014, el resto usan la ref. 1211/9012

PASO 2 - Selección medida lat. fijo

Rango (cm)	CROMO	NEGRO	Puntos
66-69	1720CR	1720N	145
76-79	1721CR	1721N	155
86-89	1722CR	1722N	165

PASO 3 - Selección soporte

Descripción	CROMO	NEGRO	Puntos
Brazo sujeción ajustable/orientable 60 cm	1715	1715N	30
Barra paralela con un soporte hasta 140 cm	1716+1718	9026+9028	60



1715



1716+1718



1715N



9026+9028

OPEN COMBI B puerta con cierre perfil imán



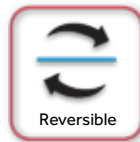

COMBI B

Rango (cm)	Apertura	CROMO	NEGRO	Puntos
42,6-46,6	33	OP45BR	-	311
43,6-47,6	33	OP45B	-	311
47,6-51,6	38	OP50BR	-	317
48,6-52,6	38	OP50B	-	317
52,6-56,6	43	OP55BR	OP55BNR	325
53,6-57,6	43	OP55B	OP55BN	325
57,6-61,6	48	OP60BR	OP60BNR	334
58,6-62,6	48	OP60B	OP60BN	334
62,6-66,6	53	OP65BR	OP65BNR	342
63,6-67,6	53	OP65B	OP65BN	342
67,6-71,6	58	OP70BR	OP70BNR	347
68,6-72,6	58	OP70B	OP70BN	347
72,6-76,6	63	OP75BR	OP75BNR	355
73,6-77,6	63	OP75B	OP75BN	355
77,6-81,6	68	OP80BR	OP80BNR	369
78,6-82,6	68	OP80B	OP80BN	369
82,6-86,6	73	OP85BR	OP85BNR	374
83,6-87,6	73	OP85B	OP85BN	374
87,6-91,6	78	OP90BR	OP90BNR	384
88,6-92,6	78	OP90B	OP90BN	384

Permite unión con laterales fijos STD en lado perfil cierre imán (rango mínimo +0,7 cm, expansión +1,5 cm), ver pág. 198.

Permite unión con laterales fijos STD en lado puerta usando ref. 1222/9015 (rango mínimo +1,8 cm, expansión +2,5 cm), ver pág. 198.

Descripción	CROMO	NEGRO	Puntos
Perfil compensación lado cierre perfil imán +3 cm	0218	9016	35
Perfil compensación lado cierre perfil imán +6 cm	0029	-	45
Perfil expansor lado puerta +2,5 cm, ver pág. 295	1222	9015	48
Juego gomas apertura IN-OUT 180°	1213		38
Juego gomas imán expansión +1,2 cm, ver pág. 295	1221		24

OPEN COMBI C fijo + puerta abatible con cierre imán a pared

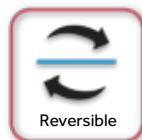



Opciones accesorios

Descripción.	● CROMO	● NEGRO	Puntos
Perfil compensación lado cierre perfil imán +3 cm	0218	9016	35
Perfil compensación lado cierre perfil imán +6 cm	0029	-	45
Juego gomas imán expansión +1,2 cm, ver pág. 295	1221		24
Juego gomas apertura IN-OUT 180°	1213		38





Paneles fijos a medida (ver pág. 289)

PASO 1 - Selección soporte

Descripción	 CROMO	 NEGRO	Puntos
Brazo sujeción ajustable/orientable 60 cm	1715	1715N	30
Barra paralela con un soporte hasta 140 cm	1716	9026	44

PASO 2 - Selección combi C (fijo+puerta)

Medidas	Rango	Fijo	Puerta	Apertura	 CROMO	 NEGRO	Puntos
70	67,5-70	20	50	43	OP2050C	OP2050CN	330
75	72,5-75	25	50	43	OP2550C	OP2550CN	337
75	72,5-75	20	55	48	OP2055C	OP2055CN	339
80	77,5-80	30	50	43	OP3050C	OP3050CN	344
80	77,5-80	25	55	48	OP2555C	OP2555CN	346
80	77,5-80	20	60	53	OP2060C	OP2060CN	347
85	82,5-85	30	55	48	OP3055C	OP3055CN	353
85	82,5-85	25	60	53	OP2560C	OP2560CN	354
85	82,5-85	20	65	58	OP2065C	OP2065CN	352
90	87,5-90	40	50	43	OP4050C	OP4050CN	360
90	87,5-90	30	60	53	OP3060C	OP3060CN	361
90	87,5-90	25	65	58	OP2565C	OP2565CN	359
90	87,5-90	20	70	63	OP2070C	OP2070CN	360
95	92,5-95	40	55	48	OP4055C	OP4055CN	369
95	92,5-95	30	65	58	OP3065C	OP3065CN	366
95	92,5-95	25	70	63	OP2570C	OP2570CN	367
100	97,5-100	50	50	43	OP5050C	OP5050CN	375
100	97,5-100	40	60	53	OP4060C	OP4060CN	377
100	97,5-100	30	70	63	OP3070C	OP3070CN	374
100	97,5-100	20	80	73	OP2080C	OP2080CN	379
105	102,5-105	50	55	48	OP5055C	OP5055CN	384
105	102,5-105	40	65	58	OP4065C	OP4065CN	382
105	102,5-105	30	75	68	OP3075C	OP3075CN	388
110	107,5-110	60	50	43	OP6050C	OP6050CN	390
110	107,5-110	50	60	53	OP5060C	OP5060CN	392
110	107,5-110	40	70	63	OP4070C	OP4070CN	390
110	107,5-110	30	80	73	OP3080C	OP3080CN	393
115	112,5-115	60	55	48	OP6055C	OP6055CN	399
115	112,5-115	50	65	58	OP5065C	OP5065CN	397
115	112,5-115	40	75	68	OP4075C	OP4075CN	404
115	112,5-115	30	85	78	OP3085C	OP3085CN	403
120	117,5-120	60	60	53	OP6060C	OP6060CN	407
120	117,5-120	50	70	63	OP5070C	OP5070CN	405
120	117,5-120	40	80	73	OP4080C	OP4080CN	409
125	122,5-125	60	65	58	OP6065C	OP6065CN	412
125	122,5-125	50	75	68	OP5075C	OP5075CN	419
125	122,5-125	40	85	78	OP4085C	OP4085CN	419
130	127,5-130	60	70	63	OP6070C	OP6070CN	420
130	127,5-130	50	80	73	OP5080C	OP5080CN	424
135	132,5-135	60	75	68	OP6075C	OP6075CN	434
135	132,5-135	50	85	78	OP5085C	OP5085CN	434
140	137,5-140	60	80	73	OP6080C	OP6080CN	439
145	142,5-145	60	85	78	OP6085C	OP6085CN	449

*Permite combinación con Lateral fijo STD en lado fijo, rango mínimo +0,7 (sin ajuste), ver pág. 198

*Permite combinación con lateral fijo Glass en lado puerta, el rango del frontal se reduce 0,5 cm

OPEN COMBI C + lat. fijo



Apertura exterior
90° p/fijo



Opción in-out
0180° p/fijo



El rango del frontal aumenta 1,4 cm y
el rango del lateral fijo se reduce 1 cm
Ref. 0038 - Incremento 21 puntos



Opciones accesorios

Descripción	CROMO	NEGRO	Puntos
Perfil compensación +2 cm	0218	9016	35
Perfil compensación +4 cm	0029	-	45



Laterales fijos TRANSPARENTES a medida **6 mm** (más información en página 291)

Descripción	Ref.	Puntos	Cajonado
Lateral fijo a medida OPEN hasta 40 cm	1345	207	+21
Lateral fijo a medida OPEN de 40 hasta 80 cm	1316	282	+21
Lateral fijo a medida OPEN de 80 hasta 120 cm	1317	352	+21

*Plazo de entrega 15 días.

PASO 1 - Selección medida frontal (fijo+puerta)

Medida	Rango (cm)	Apertura	CROMO	NEGRO	Puntos
70 (20+50)	67-69,5	43	OP2050C	OP2050CN	330
75 (25+50)	72-74,5	43	OP2550C	OP2550CN	337
80 (30+50)	77-79,5	43	OP3050C	OP3050CN	344
85 (30+55)	82-84,5	48	OP3055C	OP3055CN	353
90 (40+50)	87-89,5	43	OP4050C	OP4050CN	360
95 (30+65)	92-94,5	58	OP3065C	OP3065CN	366
100 (30+70)	97-99,5	63	OP3070C	OP3070CN	374
100 (50+50)	97-99,5	43	OP5050C	OP5050CN	375
105 (40+65)	102-104,5	58	OP4065C	OP4065CN	382
110 (30+80)	107-109,5	73	OP3080C	OP3080CN	393
110 (40+70)	107-109,5	63	OP4070C	OP4070CN	390
110 (60+50)	107-109,5	43	OP6050C	OP6050CN	390
115 (50+65)	112-114,5	58	OP5065C	OP5065CN	397
120 (40+80)	117-119,5	73	OP4080C	OP4080CN	409
120 (50+70)	117-119,5	63	OP5070C	OP5070CN	405
125 (60+65)	122-124,5	58	OP6065C	OP6065CN	412
130 (50+80)	127-129,5	73	OP5080C	OP5080CN	424
130 (60+70)	127-129,5	63	OP6070C	OP6070CN	420
135 (50+85)	132-134,5	78	OP5085C	OP5085CN	434
140 (60+80)	137-139,5	73	OP6080C	OP6080CN	439
145 (60+85)	142-144,5	78	OP6085C	OP6085CN	449

*Permite unión con laterales fijos STD en el lado de la puerta usando Ref. 1222 (rango mínimo +1,8 cm), ver pág. 198.

*Se puede seleccionar cualquier otra combinación de la tabla de la pág. 169, rango -0,5 cm.

PASO 2 - Selección medida lat. fijo

Rango (cm)	CROMO	NEGRO	Puntos
66-69	1720CR	1720N	145
76-79	1721CR	1721N	155
86-89	1722CR	1722N	165

PASO 3 - Selección soporte

Descripción	CROMO	NEGRO	Puntos
Brazo sujeción ajustable/orientable 60 cm	1715+1715	1715N+1715N	60
Barra paralela con un soporte hasta 140 cm	1716+1718	9026+9028	60



1715



1716+1718



1715N



9026+9028

OPEN COMBI D fijo+ puerta abatible con cierre imán

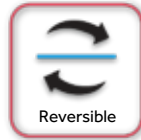



Opciones accesorios

Descripción	● CROMO	● NEGRO	Puntos
Perfil compensación lado cierre perfil imán +3 cm	0218	9016	35
Perfil compensación lado cierre perfil imán +6 cm	0029	-	45
Juego gomas imán expansión +1,2 cm, ver pág. 295	1221		24
Juego gomas apertura IN-OUT 180°	1213		38





Paneles fijos a medida (ver pág. 289)

PASO 1 - Selección soporte

Descripción	 CROMO	 NEGRO	Puntos
Brazo sujeción ajustable/orientable 60 cm	1715	1715N	30
Barra paralela con un soporte hasta 140 cm	1716	9026	44

PASO 2 - Selección combi D (fijo+puerta)

Medidas	Rango (cm)	Fijo	Puerta	Apertura	 CROMO	 NEGRO	Puntos
70	70-75	20	50	43	OP2050D	OP2050DN	390
75	75-80	25	50	43	OP2550D	OP2550DN	397
75	75-80	20	55	48	OP2055D	OP2055DN	399
80	80-85	30	50	43	OP3050D	OP3050DN	404
80	80-85	25	55	48	OP2555D	OP2555DN	406
80	80-85	20	60	53	OP2060D	OP2060DN	407
85	85-90	30	55	48	OP3055D	OP3055DN	413
85	85-90	25	60	53	OP2560D	OP2560DN	414
85	85-90	20	65	58	OP2065D	OP2065DN	412
90	90-95	40	50	43	OP4050D	OP4050DN	420
90	90-95	30	60	53	OP3060D	OP3060DN	421
90	90-95	25	65	58	OP2565D	OP2565DN	419
90	90-95	20	70	63	OP2070D	OP2070DN	420
95	95-100	40	55	48	OP4055D	OP4055DN	429
95	95-100	30	65	58	OP3065D	OP3065DN	426
95	95-100	25	70	63	OP2570D	OP2570DN	427
100	100-105	50	50	43	OP5050D	OP5050DN	435
100	100-105	40	60	53	OP4060D	OP4060DN	437
100	100-105	30	70	63	OP3070D	OP3070DN	434
100	100-105	20	80	73	OP2080D	OP2080DN	439
105	105-110	50	55	48	OP5055D	OP5055DN	444
105	105-110	40	65	58	OP4065D	OP4065DN	442
105	105-110	30	75	68	OP3075D	OP3075DN	448
110	110-115	60	50	43	OP6050D	OP6050DN	450
110	110-115	50	60	53	OP5060D	OP5060DN	452
110	110-115	40	70	63	OP4070D	OP4070DN	450
110	110-115	30	80	73	OP3080D	OP3080DN	453
115	115-120	60	55	48	OP6055D	OP6055DN	459
115	115-120	50	65	58	OP5065D	OP5065DN	457
115	115-120	40	75	68	OP4075D	OP4075DN	464
115	115-120	30	85	78	OP3085D	OP3085DN	463
120	120-125	60	60	53	OP6060D	OP6060DN	467
120	120-125	50	70	63	OP5070D	OP5070DN	465
120	120-125	40	80	73	OP4080D	OP4080DN	469
125	125-130	60	65	58	OP6065D	OP6065DN	472
125	125-130	50	75	68	OP5075D	OP5075DN	479
125	125-130	40	85	78	OP4085D	OP4085DN	479
130	130-135	60	70	63	OP6070D	OP6070DN	480
130	130-135	50	80	73	OP5080D	OP5080DN	484
135	135-140	60	75	68	OP6075D	OP6075DN	494
135	135-140	50	85	78	OP5085D	OP5085DN	494
140	140-145	60	80	73	OP6080D	OP6080DN	499
145	145-150	60	85	78	OP6085D	OP6085DN	509

*Permite combinación con Lateral fijo STD en lado fijo, rango mínimo +0,7 (sin ajuste), ver pág. 198

OPEN COMBI E + puerta abatible con cierre a fijo



Opciones accesorios

Descripción.	● CROMO	● NEGRO	Puntos
Perfil compensación lado cierre perfil imán +3 cm	0218	9016	35
Perfil puerta (reduce hasta 1 cm el rango), ver pág. 295	1215	9014	25
Perfil expansor lado puerta +2,5 cm, ver pág. 295	1222	9015	48
Juego gomas imán expansión +1,2 cm, ver pág. 295		1221	24
Juego gomas apertura IN-OUT 180°		1213	38



Paneles fijos a medida (ver pág. 289)

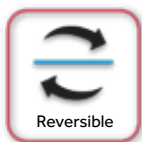

PASO 1 - Selección soporte

Descripción	CROMO	NEGRO	Puntos
Brazo sujeción ajustable/orientable 60 cm	1715	1715N	30
Barra paralela con un soporte hasta 140 cm	1716	9026	44



PASO 2 - Selección combi E (fijo + puerta)

Medidas	Rango (cm)	Fijo	Puerta	Apertura	CROMO	NEGRO	Puntos
70	68,6-72,6	20	50	43	OP2050E	OP2050EN	355
75	73,6-77,6	25	50	43	OP2550E	OP2550EN	362
80	78,6-82,6	30	50	43	OP3050E	OP3050EN	369
85	83,6-87,6	20	65	58	OP2065E	OP2065EN	377
85	83,6-87,6	30	55	48	OP3055E	OP3055EN	378
90	88,6-92,6	20	70	43	OP2070E	OP2070EN	385
90	88,6-92,6	25	65	58	OP2565E	OP2565EN	384
90	88,6-92,6	40	50	63	OP4050E	OP4050EN	385
95	93,6-97,6	25	70	63	OP2570E	OP2570EN	392
95	93,6-97,6	30	65	58	OP3065E	OP3065EN	391
100	98,6-102,6	20	80	63	OP2080E	OP2080EN	404
100	98,6-102,6	30	70	73	OP3070E	OP3070EN	399
100	98,6-102,6	50	50	43	OP5050E	OP5050EN	400
105	103,6-107,6	25	80	73	OP2580E	OP2580EN	411
105	103,6-107,6	40	65	58	OP4065E	OP4065EN	407
110	108,6-112,6	30	80	73	OP3080E	OP3080EN	418
110	108,6-112,6	40	70	63	OP4070E	OP4070EN	415
110	108,6-112,6	60	50	43	OP6050E	OP6050EN	415
115	113,6-117,6	50	65	58	OP5065E	OP5065EN	422
120	118,6-122,6	40	80	73	OP4080E	OP4080EN	434
120	118,6-122,6	50	70	63	OP5070E	OP5070EN	430
125	123,6-127,6	60	65	58	OP6065E	OP6065EN	437
130	128,6-132,6	50	80	73	OP5080E	OP5080EN	449
130	128,6-132,6	60	70	63	OP6070E	OP6070EN	445
135	133,6-137,6	50	85	78	OP5085E	OP5085EN	459
140	138,6-142,6	60	80	73	OP6080E	OP6080EN	464
145	143,6-147,6	60	85	78	OP6085E	OP6085EN	474

*Permite combinación con Lateral fijo STD en lado fijo, rango mínimo +0,7 / expansión 1,5 cm (ver pág. 198)



*Permite unión con Lateral fijo STD en lado puerta usando ref. 1222/9015, rango mínimo +1,8 cm / ajuste 2,5 cm (ver pág. 198)

ABATIBLE

OPEN COMBI F fijo + puerta abatible + fijo





Opciones accesorios

Descripción	 CROMO	 NEGRO	Puntos
Perfil compensación lado cierre perfil imán +3 cm	0218	9016	35
Perfil compensación lado cierre perfil imán +6 cm	0029	-	45
Juego gomas imán expansión +1,2 cm, ver pág. 295	1221		24
Juego gomas apertura IN-OUT 180°	1213		38







Paneles fijos a medida (ver pág. 289)

PASO 1 - Selección soporte

Descripción	 CROMO	 NEGRO	Puntos
Brazo sujeción ajustable/orientable 60 cm	1715+1715	1715N+1715N	60
Barra paralela con 2 soportes hasta 200 cm	1717	9027	60

PASO 2 - Selección combi F (fijo+puerta+fijo)

Medidas F+P+F	Rango	 CROMO	 NEGRO	Puntos	Medidas F+P+F	Rango	 CROMO	 NEGRO	Puntos
90 (20+50+20)	85-90	OP205020F	OP205020FN	420	145 (25+70+50)	140-145	OP257050F	OP257050FN	502
95 (20+50+25)	90-95	OP205025F	OP205025FN	427	145 (25+80+40)	140-145	OP258040F	OP258040FN	506
100 (25+50+25)	95-100	OP255025F	OP255025FN	434	145 (20+65+60)	140-145	OP206560F	OP206560FN	502
100 (20+50+30)	95-100	OP205030F	OP205030FN	434	150 (40+50+60)	145-150	OP405060F	OP405060FN	510
105 (25+50+30)	100-105	OP255030F	OP255030FN	441	150 (25+65+60)	145-150	OP256560F	OP256560FN	509
105 (20+65+20)	100-105	OP206520F	OP206520FN	442	150 (20+70+60)	145-150	OP207060F	OP207060FN	510
110 (20+65+25)	105-110	OP206525F	OP206525FN	449	150 (30+70+50)	145-150	OP307050F	OP307050FN	509
110 (20+70+20)	105-110	OP207020F	OP207020FN	450	150 (40+70+40)	145-150	OP407040F	OP407040FN	510
110 (30+50+30)	105-110	OP305030F	OP305030FN	448	150 (30+80+40)	145-150	OP308040F	OP308040FN	513
115 (20+65+30)	110-115	OP206530F	OP206530FN	456	150 (20+80+50)	145-150	OP208050F	OP208050FN	514
115 (20+70+25)	110-115	OP207025F	OP207025FN	457	155 (30+65+60)	150-155	OP306560F	OP306560FN	516
120 (30+50+40)	115-120	OP305040F	OP305040FN	464	155 (25+70+60)	150-155	OP257060F	OP257060FN	517
120 (25+65+30)	115-120	OP256530F	OP256530FN	463	155 (40+65+50)	150-155	OP406550F	OP406550FN	517
120 (20+70+30)	115-120	OP207030F	OP207030FN	464	155 (25+80+50)	150-155	OP258050F	OP258050FN	521
120 (20+80+20)	115-120	OP208020F	OP208020FN	469	160 (50+50+60)	155-160	OP505060F	OP505060FN	525
125 (20+65+40)	120-125	OP206540F	OP206540FN	472	160 (30+70+60)	155-160	OP307060F	OP307060FN	524
125 (30+65+30)	120-125	OP306530F	OP306530FN	470	160 (40+70+50)	155-160	OP407050F	OP407050FN	525
125 (25+70+30)	120-125	OP257030F	OP257030FN	471	160 (30+80+50)	155-160	OP308050F	OP308050FN	528
125 (25+80+20)	120-125	OP258020F	OP258020FN	476	160 (20+80+60)	155-160	OP208060F	OP208060FN	529
130 (25+65+40)	125-130	OP256540F	OP256540FN	479	160 (40+80+40)	155-160	OP408040F	OP408040FN	529
130 (20+70+40)	125-130	OP207040F	OP207040FN	480	165 (40+65+60)	160-165	OP406560F	OP406560FN	532
130 (30+70+30)	125-130	OP307030F	OP307030FN	478	165 (50+65+50)	160-165	OP506550F	OP506550FN	532
130 (20+80+30)	125-130	OP208030F	OP208030FN	483	165 (25+80+60)	160-165	OP258060F	OP258060FN	536
130 (20+50+60)	125-130	OP205060F	OP205060FN	480	170 (60+50+60)	165-170	OP605060F	OP605060FN	540
135 (20+65+50)	130-135	OP206550F	OP206550FN	487	170 (40+70+60)	165-170	OP407060F	OP407060FN	540
135 (30+65+40)	130-135	OP306540F	OP306540FN	486	170 (50+70+50)	165-170	OP507050F	OP507050FN	540
135 (25+70+40)	130-135	OP257040F	OP257040FN	487	170 (30+80+60)	165-170	OP308060F	OP308060FN	543
135 (25+80+30)	130-135	OP258030F	OP258030FN	490	170 (40+80+50)	165-170	OP408050F	OP408050FN	544
135 (25+50+60)	130-135	OP255060F	OP255060FN	487	175 (50+65+60)	170-175	OP506560F	OP506560FN	547
140 (25+65+50)	135-140	OP256550F	OP256550FN	494	180 (50+70+60)	175-180	OP507060F	OP507060FN	555
140 (20+70+50)	135-140	OP207050F	OP207050FN	495	180 (40+80+60)	175-180	OP408060F	OP408060FN	559
140 (30+70+40)	135-140	OP307040F	OP307040FN	494	180 (50+80+50)	175-180	OP508050F	OP508050FN	559
140 (20+80+40)	135-140	OP208040F	OP208040FN	499	185 (60+65+60)	180-185	OP606560F	OP606560FN	562
140 (30+80+30)	135-140	OP308030F	OP308030FN	497	190 (60+70+60)	185-190	OP607060F	OP607060FN	570
140 (30+50+60)	135-140	OP305060F	OP305060FN	494	190 (50+80+60)	185-190	OP508060F	OP508060FN	574
145 (30+65+50)	140-145	OP306550F	OP306550FN	501	200 (60+80+60)	195-200	OP608060F	OP608060FN	589
145 (40+65+40)	140-145	OP406540F	OP406540FN	502					

*Permite unión con Lateral fijo STD en ambos lados (rango mínimo +0,7 cm / ajuste 2,5 cm), ver pág. 198.

*Permite uso perfil compensación en ambos lados

OPEN COMBI G fijo + 2 puertas abatibles + fijo



PASO 1 - Selección soporte

Descripción	● CROMO	● NEGRO	Puntos
Brazo sujeción ajustable/orientable 60 cm	1715+1715	1715N+1715N	60
Barra paralela con 2 soportes hasta 200 cm	1717	9027	60



PASO 2 - Selección combi G (fijo+puerta+puerta+fijo)

Medidas F+P+P+F	Rango (cm)	CROMO	NEGRO	Puntos
135 (20+50+50+20)	131,2/136,2	OP20505020G	OP20505020GN	660
145 (25+50+50+25)	141,2/146,2	OP25505025G	OP25505025GN	674
145 (20+55+55+20)	141,2/146,2	OP20555520G	OP20555520GN	678
155 (30+50+50+30)	151,2/156,2	OP30505030G	OP30505030GN	688
155 (25+55+55+25)	151,2/156,2	OP25555525G	OP25555525GN	692
155 (20+60+60+20)	151,2/156,2	OP20606020G	OP20606020GN	694
165 (30+55+55+30)	161,2/166,2	OP30555530G	OP30555530GN	706
165 (25+60+60+25)	161,2/166,2	OP25606025G	OP25606025GN	708
165 (20+65+65+20)	161,2/166,2	OP20656520G	OP20656520GN	704
175 (40+50+50+40)	171,2/176,2	OP40505040G	OP40505040GN	720
175 (30+60+60+30)	171,2/176,2	OP30606030G	OP30606030GN	722
175 (25+65+65+25)	171,2/176,2	OP25656525G	OP25656525GN	718
175 (20+70+70+20)	171,2/176,2	OP20707020G	OP20707020GN	720
185 (40+55+55+40)	181,2/186,2	OP40555540G	OP40555540GN	738
185 (30+65+65+30)	181,2/186,2	OP30656530G	OP30656530GN	732
185 (25+70+70+25)	181,2/186,2	OP25707025G	OP25707025GN	734
185 (20+75+75+20)	181,2/186,2	OP20757520G	OP20757520GN	748
195 (50+50+50+50)	191,2/196,2	OP50505050G	OP50505050GN	750
195 (40+60+60+40)	191,2/196,2	OP40606040G	OP40606040GN	754
195 (30+70+70+30)	191,2/196,2	OP30707030G	OP30707030GN	748
195 (25+75+75+25)	191,2/196,2	OP25757525G	OP25757525GN	762
195 (20+80+80+20)	191,2/196,2	OP20808020G	OP20808020GN	758
205 (50+55+55+50)	201,2/206,2	OP50555550G	OP50555550GN	768
205 (40+65+65+40)	201,2/206,2	OP40656540G	OP40656540GN	764
205 (30+75+75+30)	201,2/206,2	OP30757530G	OP30757530GN	776
205 (25+80+80+25)	201,2/206,2	OP25808025G	OP25808025GN	772
205 (20+85+85+20)	201,2/206,2	OP20858520G	OP20858520GN	778
215 (60+50+50+60)	211,2/216,2	OP60505060G	OP60505060GN	780
215 (50+60+60+50)	211,2/216,2	OP50606050G	OP50606050GN	784
215 (40+70+70+40)	211,2/216,2	OP40707040G	OP40707040GN	780
215 (30+80+80+30)	211,2/216,2	OP30808030G	OP30808030GN	786
215 (25+85+85+25)	211,2/216,2	OP25858525G	OP25858525GN	792
225 (60+55+55+60)	221,2/226,2	OP60555560G	OP60555560GN	798
225 (50+65+65+50)	221,2/226,2	OP50656550G	OP50656550GN	794
225 (40+75+75+40)	221,2/226,2	OP40757540G	OP40757540GN	808
225 (30+85+85+30)	221,2/226,2	OP30858530G	OP30858530GN	806
235 (60+60+60+60)	231,2/236,2	OP60606060G	OP60606060GN	814
235 (50+70+70+50)	231,2/236,2	OP50707050G	OP50707050GN	810
235 (40+80+80+40)	231,2/236,2	OP40808040G	OP40808040GN	818
245 (60+65+65+60)	241,2/246,2	OP60656560G	OP60656560GN	824
245 (50+75+75+50)	241,2/246,2	OP50757550G	OP50757550GN	838
245 (40+85+85+40)	241,2/246,2	OP40858540G	OP40858540GN	838
255 (60+70+70+60)	251,2/256,2	OP60707060G	OP60707060GN	840
255 (50+80+80+50)	251,2/256,2	OP50808050G	OP50808050GN	848
265 (60+75+75+60)	261,2/266,2	OP60757560G	OP60757560GN	868
265 (50+85+85+50)	261,2/266,2	OP50858550G	OP50858550GN	868
275 (60+80+80+60)	271,2/276,2	OP60808060G	OP60808060GN	878
285 (60+85+85+60)	281,2/286,2	OP60858560G	OP60858560GN	898

ABATIBLE

*Permite unión con Lateral fijo STD en ambos lados (rango mínimo +0,7 cm / ajuste 2,5 cm), ver pág. 198.

*Permite uso perfil compensación en ambos lados



*Otras combinaciones ver desglose pág. 197

OPEN COMBI H angular 2 puertas + 2 fijos



OP3070C+OP2050C+1716+1716+1730



Opciones accesorios



Descripción	 CROMO	 NEGRO	Puntos
Perfil compensación lado cierre perfil imán +3 cm	0218	9016	35
Perfil compensación lado cierre perfil imán +6 cm	0029	-	45

PASO 1 - Selección soporte

Descripción	 CROMO	 NEGRO	Puntos
Brazo sujeción ajustable/orientable 60 cm	1715+1715	1715N+1715N	60
Barra paralela con un soporte hasta 140 cm	1716+1716+1730	-	103



PASO 2 - Selección de 2 lados de la mampara (fijo+puerta)

Medidas	Rango	Fijo	Puerta	 CROMO	 NEGRO	Puntos
70	67-69,5	20	50	OP2050C	OP2050CN	330
75	72-74,5	25	50	OP2550C	OP2550CN	337
75	72-74,5	20	55	OP2055C	OP2055CN	339
80	77-79,5	30	50	OP3050C	OP3050CN	344
80	77-79,5	25	55	OP2555C	OP2555CN	346
80	77-79,5	20	60	OP2060C	OP2060CN	347
85	82-84,5	30	55	OP3055C	OP3055CN	353
85	82-84,5	25	60	OP2560C	OP2560CN	354
85	82-84,5	20	65	OP2065C	OP2065CN	352
90	87-89,5	40	50	OP4050C	OP4050CN	360
90	87-89,5	30	60	OP3060C	OP3060CN	361
90	87-89,5	25	65	OP2565C	OP2565CN	359
90	87-89,5	20	70	OP2070C	OP2070CN	360
95	92-94,5	40	55	OP4055C	OP4055CN	369
95	92-94,5	30	65	OP3065C	OP3065CN	366
95	92-94,5	25	70	OP2570C	OP2570CN	367
100	97-99,5	50	50	OP5050C	OP5050CN	375
100	97-99,5	40	60	OP4060C	OP4060CN	377
100	97-99,5	30	70	OP3070C	OP3070CN	374
100	97-99,5	25	75	OP2575C	OP2575CN	381
105	102-104,5	50	55	OP5055C	OP5055CN	384
105	102-104,5	40	65	OP4065C	OP4065CN	382
105	102-104,5	30	75	OP3075C	OP3075CN	388
105	102-104,5	25	80	OP2580C	OP2580CN	386
110	107-109,5	50	60	OP5060C	OP5060CN	392
110	107-109,5	40	70	OP4070C	OP4070CN	390
110	107-109,5	30	80	OP3080C	OP3080CN	393
115	112-114,5	50	65	OP5065C	OP5065CN	397
115	112-114,5	40	75	OP4075C	OP4075CN	404
120	117-119,5	60	60	OP6060C	OP6060CN	407
120	117-119,5	50	70	OP5070C	OP5070CN	405
120	117-119,5	40	80	OP4080C	OP4080CN	409
125	122-124,5	60	65	OP6065C	OP6065CN	412
125	122-124,5	50	75	OP5075C	OP5075CN	419
130	127-129,5	60	70	OP6070C	OP6070CN	420
130	127-129,5	50	80	OP5080C	OP5080CN	424
135	132-134,5	60	75	OP6075C	OP6075CN	434
140	137-139,5	60	80	OP6080C	OP6080CN	439

*Ejemplo: 100 (30+70) x70 (20+50) + brazos = OP3070C + OP2050C + 1715 + 1715

OPEN COMBI | 2 puertas abatibles



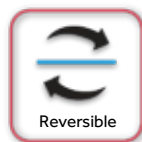

COMBI I COMBINACIONES SIMÉTRICAS

Medidas	Rango (cm)	Apertura	● CROMO	● NEGRO	Puntos
80 (40+40)	77-80	66	OP4040IR	-	431
80 (40+40)	79-82	66	OP4040I	-	431
90 (45+45)	87-90	76	OP4545IR	-	514
90 (45+45)	89-92	76	OP4545I	-	514
100 (50+50)	97-100	86	OP5050IR	OP5050INR	530
100 (50+50)	99-102	86	OP5050I	OP5050IN	530
110 (55+55)	107-110	96	OP5555IR	OP5555INR	548
110 (55+55)	109-112	96	OP5555I	OP5555IN	548
120 (60+60)	117-120	106	OP6060IR	OP6060INR	564
120 (60+60)	119-122	106	OP6060I	OP6060IN	564
130 (65+65)	127-130	116	OP6565IR	OP6565INR	574
130 (65+65)	129-132	116	OP6565I	OP6565IN	574
140 (70+70)	137-140	126	OP7070IR	OP7070INR	590
140 (70+70)	139-142	126	OP7070I	OP7070IN	590
150 (75+75)	147-150	136	OP7575IR	OP7575INR	618
150 (75+75)	149-152	136	OP7575I	OP7575IN	618
160 (80+80)	157-160	146	OP8080IR	OP8080INR	628
160 (80+80)	159-162	146	OP8080I	OP8080IN	628
170 (85+85)	167-170	156	OP8585IR	OP8585INR	648
170 (85+85)	169-172	156	OP8585I	OP8585IN	648

*Permite unión con Lateral fijo STD con ref. 1222/9015 (rango mínimo +1,8 / expansión 1,5), ver pág. 198.
Las referencias acabadas en R usan el perfil ref. 1215/9014, el resto usan la ref. 1211/9012

COMBI I COMBINACIONES ASIMÉTRICAS



Medidas	Rango (cm)	Apertura	● CROMO	● NEGRO	Puntos
85 (40+45)	84-87	71	OP4045I	-	508
95 (45+50)	94-97	81	OP4550I	-	522
105 (50+55)	104-107	91	OP5055I	OP5055IN	539
115 (55+60)	114-117	101	OP5560I	OP5560IN	556
125 (60+65)	124-127	111	OP6065I	OP6065IN	569
135 (65+70)	134-137	121	OP6570I	OP6570IN	582
145 (70+75)	144-147	131	OP7075I	OP7075IN	604
155 (75+80)	154-157	141	OP7580I	OP7580IN	623
165 (80+85)	164-167	151	OP8085I	OP8085IN	638

Descripción	● CROMO	● NEGRO	Puntos
Perfil expansor lado puerta +2,5 cm, ver pág. 295	1222	9015	48
Juego gomas imán expansión +1,2 cm, ver pág. 295	1221		24
Juego gomas apertura IN-OUT 180°	1213		38

OPEN COMBI J fijo + 2 puertas abatibles



PASO 1 - Selección soporte

Descripción	 CROMO	 NEGRO	Puntos
Brazo sujeción ajustable/orientable 60 cm	1715	1715N	30
Barra paralela con un soporte (hasta 140 cm)	1716	9026	44
Barra paralela con un soporte (hasta 200 cm)	1717	9027	60



PASO 2 - Selección combi J (fijo+puerta+puerta)

Medidas F+P+P	Rango (cm)	Apert.	CROMO	NEGRO	Puntos
95(20+40+40)	94,8-98,8	66	OP204040J	-	471
100(25+40+40)	99,8-103,8	66	OP254040J	-	478
105(30+40+40)	104,8-108,8	66	OP304040J	-	485
110(25+45+45)	109,8-113,8	76	OP254545J	-	561
115(40+40+40)	114,8-118,8	66	OP404040J	-	501
115(30+45+45)	114,8-118,8	76	OP304545J	-	568
115(20+50+50)	114,8-118,8	86	OP205050J	OP205050JN	570
120(25+50+50)	119,8-123,8	86	OP255050J	OP255050JN	577
125(50+40+40)	124,8-128,8	66	OP504040J	-	516
125(30+50+50)	124,8-128,8	86	OP305050J	OP305050JN	584
130(25+55+55)	129,8-133,8	96	OP255555J	OP255555JN	595
135(60+40+40)	134,8-138,8	66	OP604040J	-	531
135(40+50+50)	134,8-138,8	86	OP405050J	OP405050JN	600
135(30+55+55)	134,8-138,8	96	OP305555J	OP305555JN	602
140(25+60+60)	139,8-143,8	106	OP256060J	OP256060JN	611
145(50+50+50)	144,8-148,8	86	OP505050J	OP505050JN	615
145(40+55+55)	144,8-148,8	96	OP405555J	OP405555JN	618
145(30+60+60)	144,8-148,8	106	OP306060J	OP306060JN	618
150(25+65+65)	149,8-153,8	116	OP256565J	OP256565JN	621
155(60+50+50)	154,8-158,8	86	OP605050J	OP605050JN	630
155(50+55+55)	154,8-158,8	96	OP505555J	OP505555JN	633
155(40+60+60)	154,8-158,8	106	OP406060J	OP406060JN	634
160(25+70+70)	159,8-163,8	126	OP257070J	OP257070JN	637
165(60+55+55)	164,8-168,8	96	OP605555J	OP605555JN	648
165(50+60+60)	164,8-168,8	106	OP506060J	OP506060JN	649
165(40+65+65)	164,8-168,8	116	OP406565J	OP406565JN	644
170(25+75+75)	169,8-173,8	136	OP257575J	OP257575JN	665
175(60+60+60)	174,8-178,8	106	OP606060J	OP606060JN	664
175(50+65+65)	174,8-178,8	116	OP506565J	OP506565JN	659
175(40+70+70)	174,8-178,8	126	OP407070J	OP407070JN	660
180(25+80+80)	179,8-183,8	146	OP258080J	OP258080JN	675
185(60+65+65)	184,8-188,8	116	OP606565J	OP606565JN	674
185(50+70+70)	184,8-188,8	126	OP507070J	OP507070JN	675
185(40+75+75)	184,8-188,8	136	OP407575J	OP407575JN	688
190(25+85+85)	189,8-193,8	156	OP258585J	OP258585JN	695
195(60+70+70)	194,8-198,8	126	OP607070J	OP607070JN	690
195(50+75+75)	194,8-198,8	136	OP507575J	OP507575JN	703
195(40+80+80)	194,8-198,8	146	OP408080J	OP408080JN	698
205(60+75+75)	204,8-208,8	136	OP607575J	OP607575JN	718
205(50+80+80)	204,8-208,8	146	OP508080J	OP508080JN	713
205(40+85+85)	204,8-208,8	156	OP408585J	OP408585JN	718
215(60+80+80)	214,8-218,8	146	OP608080J	OP608080JN	728
215(50+85+85)	214,8-218,8	156	OP508585J	OP508585JN	733

*Permite unión con Lateral fijo STD en ambos lados (rango mínimo +0,7 cm / ajuste 2,5 cm), ver pág. 198.

*Permite uso perfil compensación en ambos lados

Descripción	CROMO	NEGRO	Puntos
Perfil puerta (reduce hasta 1 cm el rango), ver pág. 295	1215	9014	25
Perfil expansor lado puerta +2,5 cm, ver pág. 295	1222	9015	48
Juego gomas imán expansión +1,2 cm, ver pág. 295	1221		24



Paneles fijos a medida (ver pág. 289)

OPEN COMBI K 2 puertas angular



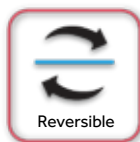

COMBI K

Medidas P+P	Rango (cm)	Apert.	CROMO	NEGRO	Puntos
40x40	40,4-41,9 / 40,4-41,9	66	OP4040K	-	431
40x45	40,4-41,9 / 45,4-46,9	76	OP4045K	-	508
45x45	45,4-46,9 / 45,4-46,9	76	OP4545K	-	514
45x50	45,4-46,9 / 50,4-51,9	86	OP4550K	-	522
45x55	45,4-46,9 / 55,4-56,9	96	OP4555K	-	531
45x60	45,4-46,9 / 60,4-61,9	106	OP4560K	-	539
45x65	45,4-46,9 / 65,4-66,9	116	OP4565K	-	544
45x70	45,4-46,9 / 70,4-71,9	126	OP4570K	-	552
45x75	45,4-46,9 / 75,4-76,9	136	OP4575K	-	566
45x80	45,4-46,9 / 80,4-81,9	146	OP4580K	-	571
50x50	50,4-51,9 / 50,4-51,9	86	OP5050K	OP5050KN	530
50x55	50,4-51,9 / 55,4-56,9	96	OP5055K	OP5055KN	539
50x60	50,4-51,9 / 60,4-61,9	106	OP5060K	OP5060KN	547
50x65	50,4-51,9 / 65,4-66,9	116	OP5065K	OP5065KN	552
50x70	50,4-51,9 / 70,4-71,9	126	OP5070K	OP5070KN	560
50x75	50,4-51,9 / 75,4-76,9	136	OP5075K	OP5075KN	574
50x80	50,4-51,9 / 80,4-81,9	146	OP5080K	OP5080KN	579
55x55	55,4-56,9 / 55,4-56,9	96	OP5555K	OP5555KN	548
55x60	55,4-56,9 / 60,4-61,9	106	OP5560K	OP5560KN	556
55x65	55,4-56,9 / 65,4-66,9	116	OP5565K	OP5565KN	561
55x70	55,4-56,9 / 70,4-71,9	126	OP5570K	OP5570KN	569
55x75	55,4-56,9 / 75,4-76,9	136	OP5575K	OP5575KN	583
55x80	55,4-56,9 / 80,4-81,9	146	OP5580K	OP5580KN	588
60x60	60,4-61,9 / 60,4-61,9	106	OP6060K	OP6060KN	564
60x65	60,4-61,9 / 65,4-66,9	116	OP6065K	OP6065KN	569
60x70	60,4-61,9 / 70,4-71,9	126	OP6070K	OP6070KN	577
60x75	60,4-61,9 / 75,4-76,9	136	OP6075K	OP6075KN	591
60x80	60,4-61,9 / 80,4-81,9	146	OP6080K	OP6080KN	596
65x65	65,4-66,9 / 65,4-66,9	116	OP6565K	OP6565KN	574
65x70	65,4-66,9 / 70,4-71,9	126	OP6570K	OP6570KN	582
65x75	65,4-66,9 / 75,4-76,9	136	OP6575K	OP6575KN	596
65x80	65,4-66,9 / 80,4-81,9	146	OP6580K	OP6580KN	601
70x70	70,4-71,9 / 70,4-71,9	126	OP7070K	OP7070KN	590
70x75	70,4-71,9 / 75,4-76,9	136	OP7075K	OP7075KN	604
70x80	70,4-71,9 / 80,4-81,9	146	OP7080K	OP7080KN	609
75x75	75,4-76,9 / 75,4-76,9	136	OP7575K	OP7575KN	618
75x80	75,4-76,9 / 80,4-81,9	146	OP7580K	OP7580KN	623
80x80	80,4-81,9 / 80,4-81,9	146	OP8080K	OP8080KN	628
80x85	80,4-81,9 / 85,4-86,9	156	OP8085K	OP8085KN	638
85x85	85,4-86,9 / 85,4-86,9	156	OP8585K	OP8585KN	648

*Permite uso perfil compensación en ambos lados

*Las referencias de la tabla incluyen perfil ref. 1211

Descripción	CROMO	NEGRO	Puntos
Perfil puerta (reduce hasta 1 cm el rango), ver pág. 295	1215	9014	25
Perfil expansor lado puerta +2,5 cm, ver pág. 295	1222	9015	48



COMBI A FROST

Rango (cm)	Apert.	Ref.	Puntos
50,1-51,6	43	OP50ASR	285
51,1-52,6	43	OP50AS	285
55,1-56,6	48	OP55ASR	294
56,1-57,6	48	OP55AS	294
60,1-61,6	53	OP60ASR	302
61,1-62,6	53	OP60AS	302
65,1-66,6	58	OP65ASR	307
66,1-67,6	58	OP65AS	307
70,1-71,6	63	OP70ASR	315
71,1-72,6	63	OP70AS	315
75,1-76,6	68	OP75ASR	329
76,1-77,6	68	OP75AS	329
80,1-81,6	73	OP80ASR	334
81,1-82,6	73	OP80AS	334
85,1-86,6	78	OP85ASR	344
86,1-87,6	78	OP85AS	344

Permite unión con laterales fijos STD en el lado de la puerta usando Ref. 1222 (rango mínimo +1,8 cm), ver pág. 198
Las combinaciones con la referencia acabada en R usan el perfil de pared 1215 y las acabadas en S el perfil 1211.

COMBI B FROST

Rango (cm)	Apert.	Ref.	Puntos
52,6-56,6	43	OP55BSR	345
53,6-57,6	43	OP55BS	345
57,6-61,6	48	OP60BSR	354
58,6-62,6	48	OP60BS	354
62,6-66,6	53	OP65BSR	362
63,6-67,6	53	OP65BS	362
67,6-71,6	58	OP70BSR	367
68,6-72,6	58	OP70BS	367
72,6-76,6	63	OP75BSR	375
73,6-77,6	63	OP75BS	375
77,6-81,6	68	OP80BSR	389
78,6-82,6	68	OP80BS	389
82,6-86,6	73	OP85BSR	394
83,6-87,6	73	OP85BS	394
87,6-91,6	78	OP90BS	404
88,6-92,6	78	OP90BSR	404

Permite unión con laterales fijos STD en lado perfil cierre imán (rango mínimo +0,7 cm, expansión +1,5 cm), ver pág. 198

Permite unión con laterales fijos STD en lado puerta usando ref. 1222 (rango mínimo +1,8 cm, expansión +2,5 cm), ver pág. 198

Las combinaciones con la referencia acabada en R usan el perfil de pared 1215 y las acabadas en S el perfil 1211.

Descripción.	Ref.	Puntos
Perfil compensación lado cierre perfil imán +3 cm	0218	35
Juego gomas imán expansión +1,2 cm, ver pág. 295	1221	24
Perfil expansor lado puerta +2,5 cm, ver pág. 295	1222	48
Juego gomas apertura IN-OUT 180°	1213	38



Opción barra paralela ref. 1716



PASO 1 - Selección soporte

Descripción	CROMO	NEGRO	Puntos
Brazo sujeción ajustable/orientable 60 cm	1715	1715N	30
Barra paralela con un soporte (hasta 140 cm)	1716	9026	44

PASO 2 - COMBI C FROST

Medida	Rango (cm)	Ref.	Puntos
80 (30+50)	77,5-80	OP3050CS	399
85 (30+55)	82,5-85	OP3055CS	408
90 (30+60)	87,5-90	OP3060CS	416
90 (40+50)	87,5-90	OP4050CS	415
95 (30+65)	92,5-95	OP3065CS	421
95 (40+55)	92,5-95	OP4055CS	424
100 (30+70)	97,5-100	OP3070CS	429
100 (40+60)	97,5-100	OP4060CS	432
105 (30+75)	102,5-105	OP3075CS	443
105 (40+65)	102,5-105	OP4065CS	437
110 (30+80)	107,5-110	OP3080CS	448
110 (40+70)	107,5-110	OP4070CS	445
110 (50+60)	107,5-110	OP5060CS	447
115 (30+85)	112,5-115	OP3085CS	458
115 (40+75)	112,5-115	OP4075CS	459
115 (50+65)	112,5-115	OP5065CS	452
120 (40+80)	117,5-120	OP4080CS	464
120 (50+70)	117,5-120	OP5070CS	460
125 (40+85)	122,5-125	OP4085CS	474
125 (50+75)	122,5-125	OP5075CS	474
125 (60+65)	122,5-125	OP6065CS	467
130 (50+80)	127,5-130	OP5080CS	479
130 (60+70)	127,5-130	OP6070CS	475
135 (50+85)	132,5-135	OP5085CS	489
135 (60+75)	132,5-135	OP6075CS	489
140 (60+80)	137,5-140	OP6080CS	494
145 (60+85)	142,5-145	OP6085CS	504

PASO 2 - COMBI D FROST

Medida	Rango (cm)	Ref.	Puntos
85 (30+50)	80-85	OP3050DS	459
90 (30+55)	85-90	OP3055DS	468
95 (30+60)	90-95	OP3060DS	476
95 (40+50)	90-95	OP4050DS	475
100 (30+65)	95-100	OP3065DS	481
100 (40+55)	95-100	OP4055DS	484
105 (30+70)	100-105	OP3070DS	489
105 (40+60)	100-105	OP4060DS	492
110 (30+75)	105-110	OP3075DS	503
110 (40+65)	105-110	OP4065DS	497
115 (30+80)	110-115	OP3080DS	508
115 (40+70)	110-115	OP4070DS	505
115 (50+60)	110-115	OP5060DS	507
120 (30+85)	115-120	OP3085DS	518
120 (40+75)	115-120	OP4075DS	519
120 (50+65)	115-120	OP5065DS	512
125 (40+80)	120-125	OP4080DS	524
125 (50+70)	120-125	OP5070DS	520
130 (40+85)	125-130	OP4085DS	534
130 (50+75)	125-130	OP5075DS	534
130 (60+65)	125-130	OP6065DS	527
135 (50+80)	130-135	OP5080DS	539
135 (60+70)	130-135	OP6070DS	535
140 (50+85)	135-140	OP5085DS	549
140 (60+75)	135-140	OP6075DS	549
145 (60+80)	140-145	OP6080DS	554
150 (60+85)	145-150	OP6085DS	564

*Permite unión con laterales fijos STD en el lado de la puerta usando Ref. 1222 (rango mínimo +1,8 cm), ver pág. 198

*Permite combinación con Lateral fijo STD en lado fijo, rango mínimo +0,7 (sin ajuste), ver pág. 198

OPEN FROST PLUS COMBI A + lat. fijo

Apertura exterior
90° p/fijo

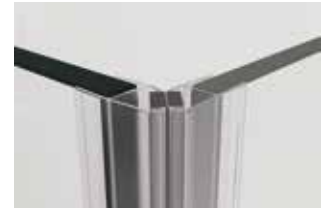

Opción in-out
0180° p/fijo



El rango del frontal aumenta
+1,4 cm y el rango del lateral
fijo se reduce -1 cm
Ref. 0038 - 21 puntos

Opciones accesorios

Descripción	Referencias	Puntos
Perfil compensación +2 cm	0218	35
Perfil compensación +4 cm	0029	45



Laterales fijos a medida 6 mm

Descripción	FROST PLUS		
	Ref.	Puntos	Cajonado
Lateral fijo a medida hasta 40 cm	1345+1312	329	+21
Lateral fijo a medida de 40 hasta 80 cm	1316+1313	404	+21
Lateral fijo a medida de 80 hasta 120 cm	1317+1315	474	+21

*Plazo de entrega 15 días. Más información ver pag. 291

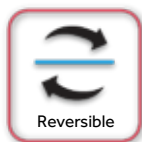

PASO 1 - Selección medida frontal (puerta)

Rango (cm)	Apertura	Referencia	Puntos
49,6-51,1	43	OP50ASR	285
50,6-52,1	43	OP50AS	285
54,6-56,1	48	OP55ASR	294
55,6-57,1	48	OP55AS	294
59,6-61,1	53	OP60ASR	302
60,6-62,1	53	OP60AS	302
64,6-66,1	58	OP65ASR	307
65,6-67,1	58	OP65AS	307
69,6-71,1	63	OP70ASR	315
70,6-72,1	63	OP70AS	315
74,6-76,1	68	OP75ASR	329
75,6-77,1	68	OP75AS	329
79,6-81,1	73	OP80ASR	334
80,6-82,1	73	OP80AS	334
84,6-86,1	78	OP85ASR	344
85,6-87,1	78	OP85AS	344

*Permite unión con laterales fijos STD en el lado de la puerta usando Ref. 1222 (rango mínimo +1,8 cm), ver pág. 198

PASO 2 - Selección medida lat. fijo

Rango (cm)	Referencia	Puntos
66-69	1292	216
76-79	1293	234
86-89	1294	253

PASO 3 - Selección soporte

Descripción	Referencia	Puntos
Brazo sujeción ajustable/orientable 60 cm	1715	30
Barra paralela con un soporte hasta 140 cm	1716+1718	60



OPEN FROST PLUS COMBI C + lat. fijo

Apertura exterior
90° p/fijo

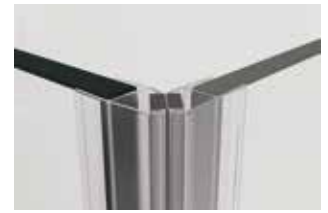

Opción in-out
0180° p/fijo



El rango del frontal aumenta
+1,4 cm y el rango del lateral
fijo se reduce -1 cm
Ref. 0038 - 21 puntos

Opciones accesorios

Descripción	Referencias	Puntos
Perfil compensación +2 cm	0218	35
Perfil compensación +4 cm	0029	45



Laterales fijos a medida **6 mm**

Descripción	FROST PLUS		
	Ref.	Puntos	Cajonado
Lateral fijo a medida hasta 40 cm	1345+1312	329	+21
Lateral fijo a medida de 40 hasta 80 cm	1316+1313	404	+21
Lateral fijo a medida de 80 hasta 120 cm	1317+1315	474	+21

*Plazo de entrega 15 días. Más información ver pag. 291

PASO 1 - Selección medida frontal (fijo+puerta)

Medida	Rango (cm)	Referencia	Puntos
80 (30+50)	77,5-80	OP3050CS	399
85 (30+55)	82,5-85	OP3055CS	408
90 (30+60)	87,5-90	OP3060CS	416
90 (40+50)	87,5-90	OP4050CS	415
95 (30+65)	92,5-95	OP3065CS	421
95 (40+55)	92,5-95	OP4055CS	424
100 (30+70)	97,5-100	OP3070CS	429
100 (40+60)	97,5-100	OP4060CS	432
100 (50+50)	97,5-100	OP5050CS	430
105 (30+75)	102,5-105	OP3075CS	443
105 (40+65)	102,5-105	OP4065CS	437
105 (50+55)	102,5-105	OP5055CS	439
110 (30+80)	107,5-110	OP3080CS	448
110 (40+70)	107,5-110	OP4070CS	445
110 (50+60)	107,5-110	OP5060CS	447
110 (60+50)	107,5-110	OP6050CS	445
115 (30+85)	112,5-115	OP3085CS	458
115 (40+75)	112,5-115	OP4075CS	459
115 (50+65)	112,5-115	OP5065CS	452
115 (60+55)	112,5-115	OP6055CS	454
120 (40+80)	117,5-120	OP4080CS	464
120 (50+70)	117,5-120	OP5070CS	460
120 (60+60)	117,5-120	OP6060CS	462
125 (40+85)	122,5-125	OP4085CS	474
125 (50+75)	122,5-125	OP5075CS	474
125 (60+65)	122,5-125	OP6065CS	467
130 (50+80)	127,5-130	OP5080CS	479
130 (60+70)	127,5-130	OP6070CS	475
135 (50+85)	132,5-135	OP5085CS	489
135 (60+75)	132,5-135	OP6075CS	489
140 (60+80)	137,5-140	OP6080CS	494
145 (60+85)	142,5-145	OP6085CS	504

*Permite unión con laterales fijos STD en el lado de la puerta usando Ref. 1222 (rango mínimo +1,8 cm), ver pág. 198

PASO 2 - Selección medida lat. fijo

Rango (cm)	Referencia	Puntos
66-69	1292	216
76-79	1293	234
86-89	1294	253

PASO 3 - Selección soporte

Descripción	Referencia	Puntos
Brazo sujeción ajustable/orientable 60 cm	1715+1715	60
Barra paralela con un soporte hasta 140 cm	1716+1718	60





COMBI G FROST

PASO 1 - Selección medida combi G

Medida	Rango (cm)	Ref.	Puntos
155 (30+50+50+30)	151,2/156,2	OP30505030GS	798
165 (30+55+55+30)	161,2/166,2	OP30555530GS	816
175 (40+50+50+40)	171,2/176,2	OP40505040GS	830
175 (30+60+60+30)	171,2/176,2	OP30606030GS	832
185 (40+55+55+40)	181,2/186,2	OP40555540GS	848
185 (30+65+65+30)	181,2/186,2	OP30656530GS	842
195 (50+50+50+50)	191,2/196,2	OP50505050GS	860
195 (40+60+60+40)	191,2/196,2	OP40606040GS	864
195 (30+70+70+30)	191,2/196,2	OP30707030GS	858
205 (50+55+55+50)	201,2/206,2	OP50555550GS	878
205 (40+65+65+40)	201,2/206,2	OP40656540GS	874
205 (30+75+75+30)	201,2/206,2	OP30757530GS	886
215 (60+50+50+60)	211,2/216,2	OP60505060GS	890
215 (50+60+60+50)	211,2/216,2	OP50606050GS	894
215 (40+70+70+40)	211,2/216,2	OP40707040GS	890
215 (30+80+80+30)	211,2/216,2	OP30808030GS	896
225 (60+55+55+60)	221,2/226,2	OP60555560GS	908
225 (50+65+65+50)	221,2/226,2	OP50656550GS	904
225 (40+75+75+40)	221,2/226,2	OP40757540GS	918
225 (30+85+85+30)	221,2/226,2	OP30858530GS	916
235 (60+60+60+60)	231,2/236,2	OP60606060GS	924
235 (50+70+70+50)	231,2/236,2	OP50707050GS	920
235 (40+80+80+40)	231,2/236,2	OP40808040GS	928
245 (60+65+65+60)	241,2/246,2	OP60656560GS	934
245 (50+75+75+50)	241,2/246,2	OP50757550GS	948
245 (40+85+85+40)	241,2/246,2	OP40858540GS	948
255 (60+70+70+60)	251,2/256,2	OP60707060GS	950
255 (50+80+80+50)	251,2/256,2	OP50808050GS	958
265 (60+75+75+60)	261,2/266,2	OP60757560GS	978
265 (50+85+85+50)	261,2/266,2	OP50858550GS	978
275 (60+80+80+60)	271,2/276,2	OP60808060GS	988
285 (60+85+85+60)	281,2/286,2	OP60858560GS	1008

PASO 2 - Selección soporte

Descripción	Referencia	Puntos
Brazo ajust./orient. 60 cm	1715+1715	60
Barra paralela 200 cm	1717	60

*Permite unión con Lateral fijo STD en ambos lados (rango mínimo +0,7 cm / ajuste 2,5 cm), ver pág. 198

*Permite uso perfil compensación en ambos lados



Descripción	Ref.	Puntos
Perfil compensación +3 cm	0218	35
Perfil compensación +6 cm	0029	45
Juego gomas imán expansión +1,2 cm	1221	24



Paneles fijos a medida (ver pág. 289)



COMBI H FROST

PASO 1 - Selección 2 lados de la mampara

Medida	Rango (cm)	Ref.	Puntos
80 (30+50)	77,5-80	OP3050CS	399
85 (30+55)	82,5-85	OP3055CS	408
90 (30+60)	87,5-90	OP3060CS	416
90 (40+50)	87,5-90	OP4050CS	415
95 (30+65)	92,5-95	OP3065CS	421
95 (40+55)	92,5-95	OP4055CS	424
100 (30+70)	97,5-100	OP3070CS	429
100 (40+60)	97,5-100	OP4060CS	432
100 (50+50)	97,5-100	OP5050CS	430
105 (30+75)	102,5-105	OP3075CS	443
105 (40+65)	102,5-105	OP4065CS	437
105 (50+55)	102,5-105	OP5055CS	439
110 (30+80)	107,5-110	OP3080CS	448
110 (40+70)	107,5-110	OP4070CS	445
110 (50+60)	107,5-110	OP5060CS	447
110 (60+50)	107,5-110	OP6050CS	445
115 (30+85)	112,5-115	OP3085CS	458
115 (40+75)	112,5-115	OP4075CS	459
115 (50+65)	112,5-115	OP5065CS	452
115 (60+55)	112,5-115	OP6055CS	454
120 (40+80)	117,5-120	OP4080CS	464
120 (50+70)	117,5-120	OP5070CS	460
120 (60+60)	117,5-120	OP6060CS	462
125 (40+85)	122,5-125	OP4085CS	474
125 (50+75)	122,5-125	OP5075CS	474
125 (60+65)	122,5-125	OP6065CS	467
130 (50+80)	127,5-130	OP5080CS	479
130 (60+70)	127,5-130	OP6070CS	475
135 (50+85)	132,5-135	OP5085CS	489
135 (60+75)	132,5-135	OP6075CS	489
140 (60+80)	137,5-140	OP6080CS	494
145 (60+85)	142,5-145	OP6085CS	504

PASO 2 - Selección soporte

Descripción	Referencia	Puntos
Brazo ajustable/orientable 60 cm	1715+1715	60
Barra paralela hasta 140 cm	1716+1716+1730	44

*Permite uso perfil compensación en ambos lados

Ejemplo: 100x80 = OP4060CS+OP3050CS+1715+1715

Descripción	Referencias	Puntos
Perfil compensación +3 cm	0218	35
Perfil compensación +6 cm	0029	45



Paneles fijos a medida (ver pág. 289)

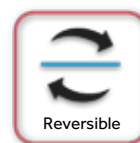



COMBI I FROST

COMBINACIONES SIMÉTRICAS

Rango	Apertura	Ref.	Puntos
97-100	86	OP5050ISR	570
99-102	86	OP5050IS	570
107-110	96	OP5555ISR	588
109-112	96	OP5555IS	588
117-120	106	OP6060ISR	604
119-122	106	OP6060IS	604
127-130	116	OP6565ISR	614
129-132	116	OP6565IS	614
137-140	126	OP7070ISR	630
139-142	126	OP7070IS	630
147-150	136	OP7575ISR	658
149-152	136	OP7575IS	658
157-160	146	OP8080ISR	668
159-162	146	OP8080IS	668
167-170	156	OP8585ISR	688
169-172	156	OP8585IS	688

COMBI I FROST

COMBINACIONES ASIMÉTRICAS

Rango	Apertura	Ref.	Puntos
104-107	111	OP6065IS	579
114-117	116	OP6570IS	596
124-127	121	OP7075IS	609
134-137	126	OP7580IS	622
144-147	131	OP8085IS	644
154-157	136	OP6060IS	663
164-167	141	OP6565ISR	678

*Permite unión con Lateral fijo STD con ref. 1222 (rango mínimo +1,8 / expansión 1,5), ver pág. 198

Las referencias acabadas en R usan el perfil ref. 1215, el resto usan la ref. 1211

Descripción	Referencias	Puntos
Perfil expansor puerta +2,5 cm	1222	48
Juego gomas imán expansión +1,2 cm	1221	24

PROGRAMA MODULAR OPEN

Fijos

Rango (cm)	TRANSPARENTE			FROST PLUS	
	CROMO	NEGRO	Puntos	Ref.	Puntos
17,5/20	1200	9024	90	-	-
22,5/25	1201	9025	97	-	-
27,5/30	1202	9000	104	1280	139
37,5/40	1203	9001	120	1281	155
47,5/50	1204	9002	135	1282	170
57,5/60	1205	9003	150	1283	185

(2,5 ajuste)

*No incluye brazo

Perfiles standard

Descripción	CROMO	NEGRO	Puntos
Perfil de pared Open	1211	9012	25
Perfil cierre imán	1212	9013	60
Perfil puerta reduce 1 cm el rango	1215	9014	25

Puertas

Pta.	TRANSPARENTE			FROST P.		A,E +1211	B +1211 +1212	C,F	D +1212	G	H	I +1211x2	J +1211
	CR	NG	Puntos	Ref.	Puntos								
40x2	1206	-	381	-	-								
40	1216	-	226	-	-	41,1/42,6	43,6/47,6	40	42,5/45	38,1	39,5	39,5/41	38,6/39,5
45	1217	-	232	-	-	46,1/47,6	48,6/52,6	45	47,5/50	43,1	44,5	44,5/46	43,6/44,3
50	1207	9004	240	1284	260	51,1/52,6	53,6/57,6	50	52,5/55	48,1	49,5	49,5/51	48,6/49,3
55	1218	9005	249	1285	269	56,1/57,6	58,6/62,6	55	57,5/60	53,1	54,5	54,5/56	53,6/54,3
60	1219	9006	257	1286	277	61,1/62,6	63,6/67,6	60	62,5/65	58,1	59,5	59,5/61	58,6/59,3
65	1208	9007	262	1287	282	66,1/67,6	68,6/72,6	65	67,5/70	63,1	64,5	64,5/66	63,6/64,3
70	1209	9008	270	1288	290	71,1/72,6	73,6/77,6	70	72,5/75	68,1	69,5	69,5/71	68,6/69,3
75	1220	9009	284	1289	304	76,1/77,6	78,6/82,6	75	77,5/80	73,1	74,5	74,5/76	73,6/74,3
80	1210	9010	289	1290	309	81,1/82,6	83,6/87,6	80	82,5/85	78,1	79,5	79,5/81	78,6/79,3
85	1223	9011	299	1291	319	86,1/87,6	88,6/92,6	85	87,5/90	83,1	84,5	84,5/86	83,6/84,3

Laterales Fijos

Descripción	Ref.	Puntos
Cristal lateral fijo de 70	1760	110
Cristal lateral fijo de 80	1761	120
Cristal lateral fijo de 90	1762	130
Descripción	Ref.	Puntos
Perfil de pared cromo	5429	35
Perfil de pared negro	5477	35

Laterales Fijos Frost

Descripción	Ref.	Puntos
Lateral fijo de 70 frost	1292	216
Lateral fijo de 80 frost	1293	234
Lateral fijo de 90 frost	1294	253

CONFIGURALO A TU MEDIDA EN NUESTRO B2B

b2b.gmelorente.com

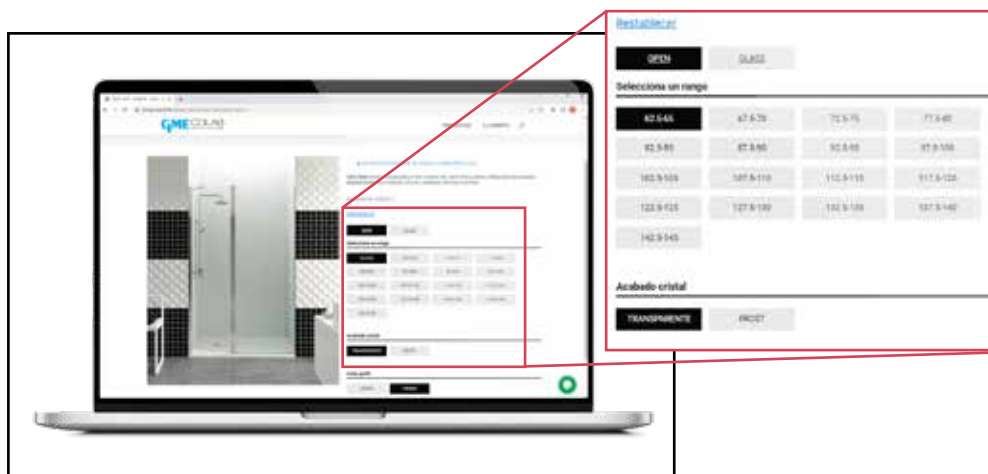

OPEN/GLASS

Lateral fijo STD transparente

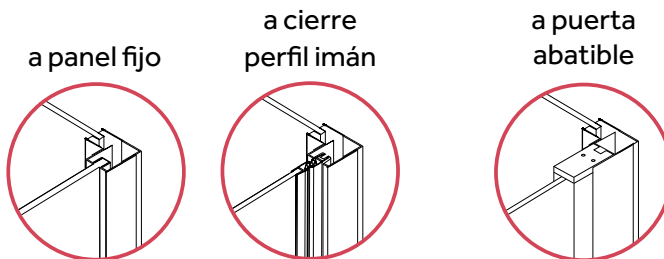

Combi E 30+70 + lat. fijo STD 70
Refs. 1202+1209+1211+0814+1715+1715



Si la unión es al lado fijo o al cierre perfil imán ref. 1212, se sumaran +0,7 cm al rango mín. de la combinación + expansión del lado libre de lateral fijo. La expansión del lado donde va el lateral fijo se pierde.

Si la unión es al lado puerta se debe utilizar la ref. 1222, se sumaran +1,8 cm al rango mínimo de la combinación + expansión del lado libre de lateral fijo.

Disponible para combinaciones

COMBI A
lado
perfil
puerta



COMBI B
ambos
lados

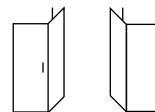

COMBI C
lado fijo

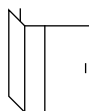

COMBI D
ambos
lados

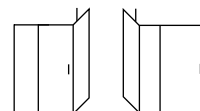

COMBI E
ambos
lados

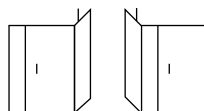

COMBI F
ambos
lados

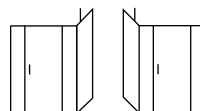

COMBI G
ambos
lados

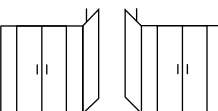

COMBI I
ambos
lados

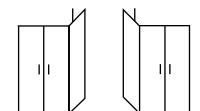

COMBI J
ambos
lados

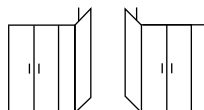

laterales fijos STD TRANSPARENTES 8 mm

Descripción	Rango	Referencias	Puntos
Lateral fijo STD 30x195 + brazo	26-29	0810+1715	185
Lateral fijo STD 40x195 + brazo	36-39	0811+1715	195
Lateral fijo STD 50x195 + brazo	46-49	0812+1715	205
Lateral fijo STD 60x195 + brazo	56-59	0813+1715	215
Lateral fijo STD 70x195 + brazo	66-69	0814+1715	225
Lateral fijo STD 75x195 + brazo	71-74	0820+1715	230
Lateral fijo STD 80x195 + brazo	76-79	0815+1715	235
Lateral fijo STD 90x195 + brazo	86-89	0816+1715	250



Opción barra paralela 140 cm ref. 1716+1718+5568
Incremento 48 p. (descontado brazo 1715)
Opción barra paralela 200 cm ref. 1717+1718+5568
Incremento 64 p. (descontado brazo 1715)

Descripción	Ref.	Puntos
Perfil compensación +2 cm	0218	35
Perfil compensación +4 cm	0029	45

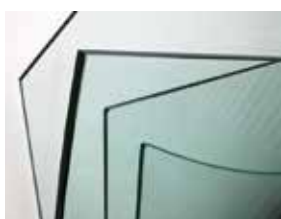

Laterales fijos a medida STD TRANSPARENTE 8 mm (más información en página 290)

Descripción	Referencias	Puntos	Cajonado
Lateral fijo a medida STD hasta 40 cm + brazo	1343+1715	205	+21
Lateral fijo a medida STD de 40 hasta 80 cm + brazo	1304+1715	280	+21
Lateral fijo a medida STD de 80 hasta 120 cm + brazo	1310+1715	350	+21

*Plazo de entrega 15 días

OPEN

Lateral fijo STD Frost Plus

a panel fijo

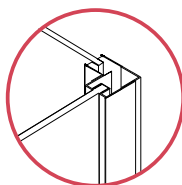

a cierre perfil imán

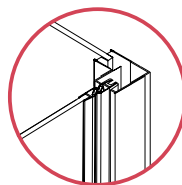

a puerta abatible

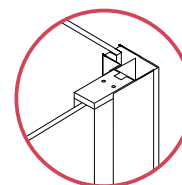

Combi C Frost 30+70 + lat. fijo Frost STD 70 + barra paralela
Refs. 1280+1288+1211+0817+1716+1718+5568



Si la unión es al lado fijo o al cierre perfil imán ref. 1212, se sumaran +0,7 cm al rango mín. de la combinación + expansión del lado libre de lateral fijo. La expansión del lado donde va el lateral fijo se pierde.

Si la unión es al lado puerta se debe utilizar la ref. 1222, se sumaran +1,8 cm al rango mínimo de la combinación + expansión del lado libre de lateral fijo.

Disponible para combinaciones

COMBI A
lado perfil puerta



COMBI B
ambos lados

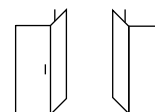

COMBI C
lado fijo

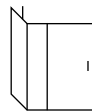

COMBI D
ambos lados

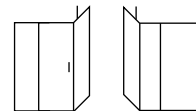

COMBI G
ambos lados

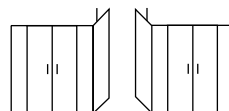

COMBI I
ambos lados

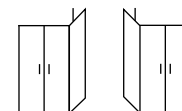

COMBI J
ambos lados

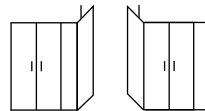

laterales fijos STD FROST PLUS 8 mm

Descripción	Rango	Referencias	Puntos
Lateral fijo STD 70x195 + brazo	66-69	0817+1715	260
Lateral fijo STD 80x195 + brazo	76-79	0818+1715	270
Lateral fijo STD 90x195 + brazo	86-89	0819+1715	280



Descripción	Referencias	Puntos
Perfil compensación +2 cm	0218	35
Perfil compensación +4 cm	0029	45



Laterales fijos a medida STD FROST PLUS 8 mm (más información en página 290)

Descripción	Referencias	Puntos	Cajonado
Lateral fijo a medida STD hasta 40 cm + brazo	1343+1312+1715	327	+21
Lateral fijo a medida STD de 40 hasta 80 cm + brazo	1304+1313+1715	402	+21
Lateral fijo a medida STD de 80 hasta 120 cm + brazo	1310+1315+1715	472	+21

*Plazo de entrega 15 días

ABATIBLE

glass

“Soluciones a cualquier espacio con la elegancia de la aperturas abatible con bisagra”

- CROMO
- NEGRO
- ORO
- NÍQUEL
- TITANIO
- COBRE
- BLANCO





GLASS BISAGRA A PARED



Descripción	Rangos	Aperturas	● CROMO	● NEGRO	● BLANCO	Puntos
Combi 1 65	65,1	59	GL65A	GL65AN	GL65ABL	283
Combi 2 65	67,6-70,1	59	GL65B	GL65BN	GL65BBL	343
Combi 1 70	70,1	64	GL70A	GL70AN	GL70ABL	288
Combi 2 70	72,6-75,1	64	GL70B	GL70BN	GL70BBL	348
Combi 1 80	80,1	74	GL80A	GL80AN	GL80ABL	300
Combi 2 80	82,6-85,1	74	GL80B	GL80BN	GL80BBL	360
Puerta a medida 60 hasta 80 cm (plazo 15 días)			1338CR	1338N	1338BL	337
Perfil compensación +2cm (solo Combi 2)			0218	9016	0218BL	35
Juego gomas imán rango +1,2 cm			1221			24

Combinaciones con lateral fijo ver página 207

GLASS BISAGRA A PARED

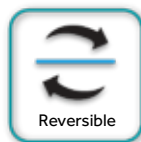

Descripción	Rangos	Aperturas	ORO	COBRE	NÍQUEL	TITANIO	Puntos
Combi 1 65	65,1	59	GL65AOR	GL65ACB	GL65ANK	GL65AT	337
Combi 2 65	67,6-70,1	59	GL65BOR	GL65BCB	GL65BNK	GL65BT	412
Combi 1 70	70,1	64	GL70AOR	GL70ACB	GL70ANK	GL70AT	342
Combi 2 70	72,6-75,1	64	GL70BOR	GL70BCB	GL70BNK	GL70BT	417
Combi 1 80	80,1	74	GL80AOR	GL80ACB	GL80ANK	GL80AT	354
Combi 2 80	82,6-85,1	74	GL80BOR	GL80BCB	GL80BNK	GL80BT	429
Puerta a medida 60 hasta 80 cm (plazo 15 días)			1338OR	1338CB	1338NK	1338T	391
Perfil compensación +2cm (solo Combi 2)			0218OR	0218CB	0218NK	0218T	45
Juego gomas imán rango +1,2 cm			1221				24

GLASS BISAGRA A PERFIL

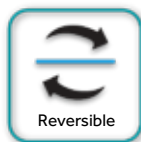

Descripción	Rangos	Aperturas	● CROMO	● NEGRO	● BLANCO	Puntos
Combi A 65	68,2-70,2	59	GL65A	GL65AN	GL65ABL	283
Combi B 65	70,7-75,2	59	GL65B	GL65BN	GL65BBL	343
Combi A 70	73,2-75,2	64	GL70A	GL70AN	GL70ABL	288
Combi B 70	75,7-80,2	64	GL70B	GL70BN	GL70BBL	348
Combi A 80	83,2-85,2	74	GL80A	GL80AN	GL80ABL	300
Combi B 80	85,7-90,2	74	GL80B	GL80BN	GL80BBL	360
Perfil compensación +2cm (solo Combi B)			0218	9016	0218BL	35
Juego gomas imán rango +1,2 cm			1221			24

GLASS BISAGRA A PERFIL

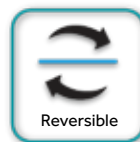

Descripción	Rangos	Aperturas	ORO	COBRE	NÍQUEL	TITANIO	Puntos
Combi A 65	68,2-70,2	59	GL65AOR	GL65ACB	GL65ANK	GL65AT	337
Combi B 65	70,7-75,2	59	GL65BOR	GL65BCB	GL65BNK	GL65BT	412
Combi A 70	73,2-75,2	64	GL70AOR	GL70ACB	GL70ANK	GL70AT	342
Combi B 70	75,7-80,2	64	GL70BOR	GL70BCB	GL70BNK	GL70BT	417
Combi A 80	83,2-85,2	74	GL80AOR	GL80ACB	GL80ANK	GL80AT	354
Combi B 80	85,7-90,2	74	GL80BOR	GL80BCB	GL80BNK	GL80BT	429
Perfil compensación +2cm (solo Combi B)			0218OR	0218CB	0218NK	0218T	45
Juego gomas imán rango +1,2 cm			1221				24

GLASS COMBI A + Lateral fijo





PASO 1 - Selección medida y color de la puerta

Rango	Apert.	● CROMO	● NEGRO	● BLANCO	Puntos
67,7-69,7	60	GL65A	GL65AN	GL65ABL	283
72,7-74,7	65	GL70A	GL70AN	GL70ABL	288
82,7-84,7	70	GL80A	GL80AN	GL80ABL	300
Puerta a medida 60 hasta 80 cm (plazo 15 días)		1338CR	1338N	1338BL	337

PASO 2 - Selección lateral fijo

Descripción	Rangos	● CROMO	● NEGRO	● BLANCO	Puntos
Lateral fijo de 70 cm	66-69	1720CR	1720N	1720BL	145
Lateral fijo de 80 cm	76-79	1721CR	1721N	1721BL	155
Lateral fijo de 90 cm	86-89	1722CR	1722N	1722BL	165

PASO 3 - Selección soporte

Descripción	● CROMO	● NEGRO	● BLANCO	Puntos
Brazo sujeción ajustable 60 cm	1715	1715N	1715B	30
Barra hasta 140 cm con un soporte	1716+1718	9026+9028	1716BL+1718BL	60

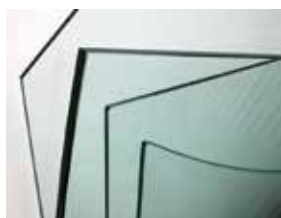

Laterales fijos a medida GLASS/OPEN 6 mm (más información en página 291)

Descripción	● CROMO	● NEGRO	● BLANCO	Puntos	Cajonado
Ancho < 40 cm	1345	1345N	1345B	207	+21
Ancho >40 y <80 cm	1316	1316N	1316B	282	+21
Ancho >80 y <120 cm	1317	1317N	1317B	352	+21

*No incluye brazo, plazo de entrega 15 días

GLASS COMBI A + Lateral fijo



Oro



Cobre



Niquel



Titanio





PASO 1 - Selección medida y color de la puerta

Rango	Apert.	ORO	COBRE	NÍQUEL	TITANIO	Puntos
67,7-69,7	60	GL65AOR	GL65ACB	GL65ANK	GL65AT	337
72,7-74,7	65	GL70AOR	GL70ACB	GL70ANK	GL70AT	342
82,7-84,7	75	GL80AOR	GL80ACB	GL80ANK	GL80AT	354
Puerta a medida 60 hasta 80 cm (plazo 15 días)		1338OR	1338CB	1338NK	1338T	391

PASO 2 - Selección lateral fijo

Descripción	Rangos	ORO	COBRE	NÍQUEL	TITANIO	Puntos
Lateral fijo de 70 cm	66-69	1720OR	1720CB	1720NK	1720T	155
Lateral fijo de 80 cm	76-79	1721OR	1721CB	1721NK	1721T	165
Lateral fijo de 90 cm	86-89	1722OR	1722CB	1722NK	1722T	175

PASO 3 - Selección soporte

Descripción	ORO	COBRE	NÍQUEL	TITANIO	P.
Brazo sujeción ajustable 60 cm	1715OR	1715CB	1715NK	1715T	40
Barra hasta 140 cm con un soporte	1716OR+1718OR	1716CB+1718CB	1716NK+1718NK	1716T+1718T	80



Laterales fijos a medida GLASS/OPEN 6 mm (más información en página 291)

Descripción	ORO	COBRE	NÍQUEL	TITANIO	Puntos	Cajonado
Ancho < 40 cm	1345OR	1345CB	1345NK	1345T	217	+21
Ancho >40 y <80 cm	1316OR	1316CB	1316NK	1316T	292	+21
Ancho >80 y <120 cm	1317OR	1317CB	1317NK	1317T	362	+21

*No incluye brazo, plazo de entrega 15 días

GLASS COMBI C Fijo + puerta abatible con cierre imán a pared



Cromo



Negro



Blanco



Cierre imán a pared



Paneles fijos y puertas a medida ver pág. 289



PASO 1 - Selección medida y color (fijo+puerta)

Rango	Fijo	Puerta	Apert.	CROMO	NEGRO	BLANCO	Puntos
67-70	20	50	47	GL2050C	GL2050CN	GL2050CBL	294
72-74	25	50	47	GL2550C	GL2550CN	GL2550CBL	301
77-80	30	50	47	GL3050C	GL3050CN	GL3050CBL	308
82-85	20	65	62	GL2065C	GL2065CN	GL2065CBL	314
87-90	25	65	62	GL2565C	GL2565CN	GL2565CBL	321
87-90	20	70	67	GL2070C	GL2070CN	GL2070CBL	319
87-90	40	50	47	GL4050C	GL4050CN	GL4050CBL	322
92-95	25	70	67	GL2570C	GL2570CN	GL2570CBL	326
92-95	30	65	62	GL3065C	GL3065CN	GL3065CBL	328
97-100	30	70	67	GL3070C	GL3070CN	GL3070CBL	333
97-100	50	50	47	GL5050C	GL5050CN	GL5050CBL	336
97-100	20	80	77	GL2080C	GL2080CN	GL2080CBL	331
102-105	25	80	77	GL2580C	GL2580CN	GL2580CBL	338
102-105	40	65	62	GL4065C	GL4065CN	GL4065CBL	342
107-110	30	80	77	GL3080C	GL3080CN	GL3080CBL	345
107-110	40	70	67	GL4070C	GL4070CN	GL4070CBL	347
107-110	60	50	47	GL6050C	GL6050CN	GL6050CBL	350
112-115	50	65	62	GL5065C	GL5065CN	GL5065CBL	356
117-120	40	80	77	GL4080C	GL4080CN	GL4080CBL	359
117-120	50	70	67	GL5070C	GL5070CN	GL5070CBL	361
122-125	60	65	62	GL6065C	GL6065CN	GL6065CBL	370
127-130	50	80	77	GL5080C	GL5080CN	GL5080CBL	373
127-130	60	70	67	GL6070C	GL6070CN	GL6070CBL	375
137-140	60	80	77	GL6080C	GL6080CN	GL6080CBL	387

*Permite combinación con lateral fijo Glass en lado puerta, el rango del frontal se reducirá en 0,5 cm. Expansión 3 cm. Ver pág. 215

PASO 2 - Selección soporte

Descripción	CROMO	NEGRO	BLANCO	Puntos
Brazo sujeción ajustable 60 cm	1715	1715N	1715B	30
Barra hasta 140 cm con un soporte	1716	9026	1716BL	44



Descripción	CROMO	NEGRO	BLANCO	Puntos
Perfil compensación +2 cm lado fijo	0218	9016	0218BL	35
Perfil compensación +4 cm lado fijo	0029			45
Imán expansión +1,2 cm (ver pág. 295)		1221		24

GLASS COMBI C Fijo + puerta abatible con cierre imán a pared



Paneles fijos y puertas a medida ver pág. 289



PASO 1 - Selección medida y color (fijo+puerta)

Rango	Fijo	Puerta	Apert.	ORO	COBRE	NÍQUEL	TITANIO	Puntos
67-70	20	50	47	GL2050COR	GL2050CCB	GL2050CNK	GL2050CT	357
72-74	25	50	47	GL2550COR	GL2550CCB	GL2550CNK	GL2550CT	364
77-80	30	50	47	GL3050COR	GL3050CCB	GL3050CNK	GL3050CT	371
82-85	20	65	62	GL2065COR	GL2065CCB	GL2065CNK	GL2065CT	377
87-90	25	65	62	GL2565COR	GL2565CCB	GL2565CNK	GL2565CT	384
87-90	20	70	67	GL2070COR	GL2070CCB	GL2070CNK	GL2070CT	382
87-90	40	50	47	GL4050COR	GL4050CCB	GL4050CNK	GL4050CT	385
92-95	25	70	67	GL2570COR	GL2570CCB	GL2570CNK	GL2570CT	389
92-95	30	65	62	GL3065COR	GL3065CCB	GL3065CNK	GL3065CT	391
97-100	30	70	67	GL3070COR	GL3070CCB	GL3070CNK	GL3070CT	396
97-100	50	50	47	GL5050COR	GL5050CCB	GL5050CNK	GL5050CT	399
97-100	20	80	77	GL2080COR	GL2080CCB	GL2080CNK	GL2080CT	394
102-105	25	80	77	GL2580COR	GL2580CCB	GL2580CNK	GL2580CT	401
102-105	40	65	62	GL4065COR	GL4065CCB	GL4065CNK	GL4065CT	405
107-110	30	80	77	GL3080COR	GL3080CCB	GL3080CNK	GL3080CT	408
107-110	40	70	67	GL4070COR	GL4070CCB	GL4070CNK	GL4070CT	410
107-110	60	50	47	GL6050COR	GL6050CCB	GL6050CNK	GL6050CT	413
112-115	50	65	62	GL5065COR	GL5065CCB	GL5065CNK	GL5065CT	419
117-120	40	80	77	GL4080COR	GL4080CCB	GL4080CNK	GL4080CT	422
117-120	50	70	67	GL5070COR	GL5070CCB	GL5070CNK	GL5070CT	424
122-125	60	65	62	GL6065COR	GL6065CCB	GL6065CNK	GL6065CT	433
127-130	50	80	77	GL5080COR	GL5080CCB	GL5080CNK	GL5080CT	436
127-130	60	70	67	GL6070COR	GL6070CCB	GL6070CNK	GL6070CT	438
137-140	60	80	77	GL6080COR	GL6080CCB	GL6080CNK	GL6080CT	450

*Permite combinación con lateral fijo Glass en lado puerta, el rango del frontal se reducirá en 0,5 cm. Expansión 3 cm. Ver pág. 217

PASO 2 - Selección soporte

Descripción	ORO	COBRE	NÍQUEL	TITANIO	Puntos
Brazo sujeción ajustable 60 cm	1715OR	1715CB	1715NK	1715T	40
Barra hasta 140 cm con un soporte	1716OR	1716CB	1716NK	1716T	60



Descripción	ORO	COBRE	NÍQUEL	TITANIO	Puntos
Perfil compensación +2 cm lado fijo	0218OR	0218CB	0218NK	0218T	45
Imán expansión +1,2 cm (ver pág. 295)	1221				24

GLASS COMBI C + Lateral fijo

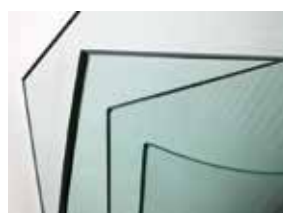

Laterales fijos a medida GLASS/OPEN 6 mm (más información en página 291)

Descripción	CROMO	NEGRO	BLANCO	Puntos	Cajonado
Ancho < 40 cm	1345	1345N	1345B	207	+21
Ancho >40 y <80 cm	1316	1316N	1316B	282	+21
Ancho >80 y <120 cm	1317	1317N	1317B	352	+21

*No incluye brazo, plazo de entrega 15 días

PASO 1 - Selección medida y color (fijo+puerta)

Rango	Fijo	Puerta	Apert.	CROMO	NEGRO	BLANCO	Puntos
66,5-69,5	20	50	47	GL2050C	GL2050CN	GL2050CBL	294
71,5-74,5	25	50	47	GL2550C	GL2550CN	GL2550CBL	301
76,5-79,5	30	50	47	GL3050C	GL3050CN	GL3050CBL	308
81,5-84,5	20	65	62	GL2065C	GL2065CN	GL2065CBL	314
86,5-89,5	25	65	62	GL2565C	GL2565CN	GL2565CBL	321
86,5-89,5	20	70	67	GL2070C	GL2070CN	GL2070CBL	319
86,5-89,5	40	50	47	GL4050C	GL4050CN	GL4050CBL	322
91,5-94,5	25	70	67	GL2570C	GL2570CN	GL2570CBL	326
91,5-94,5	30	65	62	GL3065C	GL3065CN	GL3065CBL	328
96,5-99,5	30	70	67	GL3070C	GL3070CN	GL3070CBL	333
96,5-99,5	50	50	47	GL5050C	GL5050CN	GL5050CBL	336
96,5-99,5	20	80	77	GL2080C	GL2080CN	GL2080CBL	331
101,5-104,5	25	80	77	GL2580C	GL2580CN	GL2580CBL	338
101,5-104,5	40	65	62	GL4065C	GL4065CN	GL4065CBL	342
106,5-109,5	30	80	77	GL3080C	GL3080CN	GL3080CBL	345
106,5-109,5	40	70	67	GL4070C	GL4070CN	GL4070CBL	347
106,5-109,5	60	50	47	GL6050C	GL6050CN	GL6050CBL	350
111,5-114,5	50	65	62	GL5065C	GL5065CN	GL5065CBL	356
116,5-119,5	40	80	77	GL4080C	GL4080CN	GL4080CBL	359
116,5-119,5	50	70	67	GL5070C	GL5070CN	GL5070CBL	361
121,5-124,5	60	65	62	GL6065C	GL6065CN	GL6065CBL	370
126,5-129,5	50	80	77	GL5080C	GL5080CN	GL5080CBL	373
126,5-129,5	60	70	67	GL6070C	GL6070CN	GL6070CBL	375
136,5-139,5	60	80	77	GL6080C	GL6080CN	GL6080CBL	387

PASO 2 - Selección lateral fijo

Descripción	Rangos	CROMO	NEGRO	BLANCO	Puntos
Lateral fijo de 70 cm	66-69	1720CR	1720N	1720BL	145
Lateral fijo de 80 cm	76-79	1721CR	1721N	1721BL	155
Lateral fijo de 90 cm	86-89	1722CR	1722N	1722BL	165

PASO 3 - Selección soporte

Descripción	CROMO	NEGRO	BLANCO	P.
Brazo sujeción ajustable 60 cm	1715+1715	1715N+1715N	1715B+1715B	60
Barra hasta 140 cm con un soporte	1716+1718	9026+9028	1716BL+1718BL	60



Descripción	CROMO	NEGRO	BLANCO	Puntos
Perfil compensación +2 cm lado fijo	0218	9016	0218BL	35
Perfil compensación +4 cm lado fijo	0029			45
Imán expansión +1,2 cm (ver pág. 295)	1221			24

GLASS COMBI C + Lateral fijo



Laterales fijos a medida GLASS/OPEN 6 mm (más información en página 291)

Descripción	ORO	COBRE	NÍQUEL	TITANIO	Puntos	Cajonado
Ancho < 40 cm	1345OR	1345CB	1345NK	1345T	217	+21
Ancho >40 y <80 cm	1316OR	1316CB	1316NK	1316T	292	+21
Ancho >80 y <120 cm	1317OR	1317CB	1317NK	1317T	362	+21

*No incluye brazo, plazo de entrega 15 días

PASO 1 - Selección medida y color (fijo+puerta)

Rango	Fijo	Puerta	Apert.	ORO	COBRE	NÍQUEL	TITANIO	Puntos
66,5-69,5	20	50	47	GL2050COR	GL2050CCB	GL2050CNK	GL2050CT	357
71,5-74,5	25	50	47	GL2550COR	GL2550CCB	GL2550CNK	GL2550CT	364
76,5-79,5	30	50	47	GL3050COR	GL3050CCB	GL3050CNK	GL3050CT	371
81,5-84,5	20	65	62	GL2065COR	GL2065CCB	GL2065CNK	GL2065CT	377
86,5-89,5	25	65	62	GL2565COR	GL2565CCB	GL2565CNK	GL2565CT	384
86,5-89,5	20	70	67	GL2070COR	GL2070CCB	GL2070CNK	GL2070CT	382
86,5-89,5	40	50	47	GL4050COR	GL4050CCB	GL4050CNK	GL4050CT	385
91,5-94,5	25	70	67	GL2570COR	GL2570CCB	GL2570CNK	GL2570CT	389
91,5-94,5	30	65	62	GL3065COR	GL3065CCB	GL3065CNK	GL3065CT	391
96,5-99,5	30	70	67	GL3070COR	GL3070CCB	GL3070CNK	GL3070CT	396
96,5-99,5	50	50	47	GL5050COR	GL5050CCB	GL5050CNK	GL5050CT	399
96,5-99,5	20	80	77	GL2080COR	GL2080CCB	GL2080CNK	GL2080CT	394
101,5-104,5	25	80	77	GL2580COR	GL2580CCB	GL2580CNK	GL2580CT	401
101,5-104,5	40	65	62	GL4065COR	GL4065CCB	GL4065CNK	GL4065CT	405
106,5-109,5	30	80	77	GL3080COR	GL3080CCB	GL3080CNK	GL3080CT	408
106,5-109,5	40	70	67	GL4070COR	GL4070CCB	GL4070CNK	GL4070CT	410
106,5-109,5	60	50	47	GL6050COR	GL6050CCB	GL6050CNK	GL6050CT	413
111,5-114,5	50	65	62	GL5065COR	GL5065CCB	GL5065CNK	GL5065CT	419
116,5-119,5	40	80	77	GL4080COR	GL4080CCB	GL4080CNK	GL4080CT	422
116,5-119,5	50	70	67	GL5070COR	GL5070CCB	GL5070CNK	GL5070CT	424
121,5-124,5	60	65	62	GL6065COR	GL6065CCB	GL6065CNK	GL6065CT	433
126,5-129,5	50	80	77	GL5080COR	GL5080CCB	GL5080CNK	GL5080CT	436
126,5-129,5	60	70	67	GL6070COR	GL6070CCB	GL6070CNK	GL6070CT	438
136,5-139,5	60	80	77	GL6080COR	GL6080CCB	GL6080CNK	GL6080CT	450

PASO 2 - Selección lateral fijo

Descripción	Rangos	ORO	COBRE	NÍQUEL	TITANIO	Puntos
Lateral fijo de 70 cm	66-69	1720OR	1720CB	1720NK	1720T	155
Lateral fijo de 80 cm	76-79	1721OR	1721CB	1721NK	1721T	165
Lateral fijo de 90 cm	86-89	1722OR	1722CB	1722NK	1722T	175

PASO 3 - Selección soporte

Descripción	ORO	COBRE	NÍQUEL	TITANIO	P.
Brazos sujeción ajustable 60 cm	1715OR+1715OR	1715CB+1715CB	1715NK+1715NK	1715T+1715T	80
Barra hasta 140 cm con un soporte	1716OR+1718OR	1716CB+1718CB	1716NK+1718NK	1716T+1718T	80



Descripción	ORO	COBRE	NÍQUEL	TITANIO	Puntos
Perfil compensación +2 cm lado fijo	0218OR	0218CB	0218NK	0218T	45
Imán expansión +1,2 cm (ver pág. 295)	1221				24

GLASS COMBI D Fijo + puerta abatible con cierre a perfil imán



Cromo



Negro



Blanco



Cierre a perfil imán



Paneles fijos y puertas a medida ver pág. 289



PASO 1 - Selección medida y color (fijo+puerta)

Rango	Fijo	Puerta	Apert.	CROMO	NEGRO	BLANCO	Puntos
69,5-75	20	50	43	GL2050D	GL2050DN	GL2050DBL	354
74,5-80	25	50	43	GL2550D	GL2550DN	GL2550DBL	361
79,5-85	30	50	43	GL3050D	GL3050DN	GL3050DBL	368
84,5-90	20	65	58	GL2065D	GL2065DN	GL2065DBL	374
89,5-95	25	65	58	GL2565D	GL2565DN	GL2565DBL	381
89,5-95	20	70	63	GL2070D	GL2070DN	GL2070DBL	379
89,5-95	40	50	43	GL4050D	GL4050DN	GL4050DBL	382
94,5-100	25	70	63	GL2570D	GL2570DN	GL2570DBL	386
94,5-100	30	65	53	GL3065D	GL3065DN	GL3065DBL	388
99,5-105	30	70	63	GL3070D	GL3070DN	GL3070DBL	393
99,5-105	50	50	43	GL5050D	GL5050DN	GL5050DBL	396
99,5-105	20	80	73	GL2080D	GL2080DN	GL2080DBL	391
104,5-110	25	80	73	GL2580D	GL2580DN	GL2580DBL	398
104,5-110	40	65	58	GL4065D	GL4065DN	GL4065DBL	402
109,5-115	30	80	73	GL3080D	GL3080DN	GL3080DBL	405
109,5-115	40	70	63	GL4070D	GL4070DN	GL4070DBL	407
109,5-115	60	50	43	GL6050D	GL6050DN	GL6050DBL	410
114,5-120	50	65	58	GL5065D	GL5065DN	GL5065DBL	416
119,5-125	40	80	73	GL4080D	GL4080DN	GL4080DBL	419
119,5-125	50	70	63	GL5070D	GL5070DN	GL5070DBL	421
124,5-130	60	65	58	GL6065D	GL6065DN	GL6065DBL	430
129,5-135	50	80	73	GL5080D	GL5080DN	GL5080DBL	433
129,5-135	60	70	63	GL6070D	GL6070DN	GL6070DBL	435
139,5-145	60	80	73	GL6080D	GL6080DN	GL6080DBL	447

*Permite uso perfil compensación en ambos lados en acabados cromo y negro.

*Permite combinación con Lateral fijo STD en acabados cromo y negro, rango mínimo +0,7 / expansión 3 cm (ver pág. 198)

PASO 2 - Selección soporte

Descripción	CROMO	NEGRO	BLANCO	P.
Brazo sujeción ajustable 60 cm	1715	1715N	1715B	30
Barra hasta 140 cm con un soporte	1716	9026	1716BL	44



Descripción	CROMO	NEGRO	BLANCO	Puntos
Perfil compensación +2 cm lado fijo	0218	9016	0218BL	35
Perfil compensación +4 cm lado fijo	0029			45
Imán expansión +1,2 cm (ver pág. 295)	1221			24

GLASS COMBI D Fijo + puerta abatible con cierre a perfil imán



Paneles fijos y puertas a medida ver pág. 289

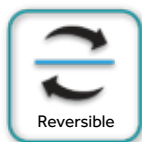

PASO 1 - Selección medida y color (fijo+puerta)

Rango	Fijo	Puerta	Apert.	ORO	COBRE	NÍQUEL	TITANIO	Puntos
69,5-75	20	50	43	GL2050DOR	GL2050DCB	GL2050DNK	GL2050DT	432
74,5-80	25	50	43	GL2550DOR	GL2550DCB	GL2550DNK	GL2550DT	439
79,5-85	30	50	43	GL3050DOR	GL3050DCB	GL3050DNK	GL3050DT	446
84,5-90	20	65	58	GL2065DOR	GL2065DCB	GL2065DNK	GL2065DT	452
89,5-95	25	65	58	GL2565DOR	GL2565DCB	GL2565DNK	GL2565DT	459
89,5-95	20	70	63	GL2070DOR	GL2070DCB	GL2070DNK	GL2070DT	457
89,5-95	40	50	43	GL4050DOR	GL4050DCB	GL4050DNK	GL4050DT	460
94,5-100	25	70	63	GL2570DOR	GL2570DCB	GL2570DNK	GL2570DT	464
94,5-100	30	65	53	GL3065DOR	GL3065DCB	GL3065DNK	GL3065DT	466
99,5-105	30	70	63	GL3070DOR	GL3070DCB	GL3070DNK	GL3070DT	471
99,5-105	50	50	43	GL5050DOR	GL5050DCB	GL5050DNK	GL5050DT	474
99,5-105	20	80	73	GL2080DOR	GL2080DCB	GL2080DNK	GL2080DT	469
104,5-110	25	80	73	GL2580DOR	GL2580DCB	GL2580DNK	GL2580DT	476
104,5-110	40	65	58	GL4065DOR	GL4065DCB	GL4065DNK	GL4065DT	480
109,5-115	30	80	73	GL3080DOR	GL3080DCB	GL3080DNK	GL3080DT	483
109,5-115	40	70	63	GL4070DOR	GL4070DCB	GL4070DNK	GL4070DT	485
109,5-115	60	50	43	GL6050DOR	GL6050DCB	GL6050DNK	GL6050DT	488
114,5-120	50	65	58	GL5065DOR	GL5065DCB	GL5065DNK	GL5065DT	494
119,5-125	40	80	73	GL4080DOR	GL4080DCB	GL4080DNK	GL4080DT	497
119,5-125	50	70	63	GL5070DOR	GL5070DCB	GL5070DNK	GL5070DT	499
124,5-130	60	65	58	GL6065DOR	GL6065DCB	GL6065DNK	GL6065DT	508
129,5-135	50	80	73	GL5080DOR	GL5080DCB	GL5080DNK	GL5080DT	511
129,5-135	60	70	63	GL6070DOR	GL6070DCB	GL6070DNK	GL6070DT	513
139,5-145	60	80	73	GL6080DOR	GL6080DCB	GL6080DNK	GL6080DT	525

PASO 2 - Selección soporte

Descripción	ORO	COBRE	NÍQUEL	TITANIO	P.
Brazo sujeción ajustable 60 cm	1715OR	1715CB	1715NK	1715T	40
Barra hasta 140 cm con un soporte	1716OR	1716CB	1716NK	1716T	60



Descripción	ORO	COBRE	NÍQUEL	TITANIO	Puntos
Perfil compensación +2 cm lado fijo	0218OR	0218CB	0218NK	0218T	45
Imán expansión +1,2 cm (ver pág. 295)	1221				24

GLASS COMBI G Fijo + 2 puertas abatibles + fijo



Cromo



Negro



Blanco



Cierre imán



Paneles fijos y puertas a medida ver pág. 289

PASO 1 - Selección medida y color (fijo+pta+pta+fijo)

Rango	Medidas F+P+P+F	Apert.	CROMO	NEGRO	BLANCO	Puntos
129,5-135,5	20+50+50+20	90	GL20505020G	GL20505020GN	GL20505020GBL	588
129,5-135,5	25+45+45+25	80	GL25454525G	GL25454525GN	GL25454525GBL	590
129,5-135,5	30+40+40+30	75	GL30404030G	GL30404030GN	GL30404030GBL	592
139,5-145,5	25+50+50+25	90	GL25505025G	GL25505025GN	GL25505025GBL	602
139,5-145,5	30+45+45+30	80	GL30454530G	GL30454530GN	GL30454530GBL	604
139,5-145,5	40+35+35+40	65	GL40353540G	GL40353540GN	GL40353540GBL	608
149,5-155,5	30+50+50+30	90	GL30505030G	GL30505030GN	GL30505030GBL	616
149,5-155,5	40+40+40+40	70	GL40404040G	GL40404040GN	GL40404040GBL	620
159,5-165,5	20+65+65+20	120	GL20656520G	GL20656520GN	GL20656520GBL	628
159,5-165,5	40+45+45+40	80	GL40454540G	GL40454540GN	GL40454540GBL	632
159,5-165,5	50+35+35+50	60	GL50353550G	GL50353550GN	GL50353550GBL	636
169,5-175,5	20+70+70+20	130	GL20707020G	GL20707020GN	GL20707020GBL	638
169,5-175,5	25+65+65+25	120	GL25656525G	GL25656525GN	GL25656525GBL	642
169,5-175,5	40+50+50+40	90	GL40505040G	GL40505040GN	GL40505040GBL	644
169,5-175,5	50+40+40+50	70	GL50404050G	GL50404050GN	GL50404050GBL	648
179,5-185,5	25+70+70+25	130	GL25707025G	GL25707025GN	GL25707025GBL	652
179,5-185,5	30+65+65+30	120	GL30656530G	GL30656530GN	GL30656530GBL	656
179,5-185,5	50+45+45+50	80	GL50454550G	GL50454550GN	GL50454550GBL	660
179,5-185,5	60+35+35+60	60	GL60353560G	GL60353560GN	GL60353560GBL	664
189,5-195,5	20+80+80+20	150	GL20808020G	GL20808020GN	GL20808020GBL	662
189,5-195,5	30+70+70+30	130	GL30707030G	GL30707030GN	GL30707030GBL	666
189,5-195,5	50+50+50+50	90	GL50505050G	GL50505050GN	GL50505050GBL	672
189,5-195,5	60+40+40+60	70	GL60404060G	GL60404060GN	GL60404060GBL	676
199,5-205,5	25+80+80+25	150	GL25808025G	GL25808025GN	GL25808025GBL	676
199,5-205,5	40+65+65+40	120	GL40656540G	GL40656540GN	GL40656540GBL	684
199,5-205,5	60+45+45+60	80	GL60454560G	GL60454560GN	GL60454560GBL	688
209,5-215,5	30+80+80+30	150	GL30808030G	GL30808030GN	GL30808030GBL	690
209,5-215,5	40+70+70+40	130	GL40707040G	GL40707040GN	GL40707040GBL	694
209,5-215,5	60+50+50+60	90	GL60505060G	GL60505060GN	GL60505060GBL	700
219,5-225,5	50+65+65+50	120	GL50656550G	GL50656550GN	GL50656550GBL	712
229,5-235,5	40+80+80+40	150	GL40808040G	GL40808040GN	GL40808040GBL	718
229,5-235,5	50+70+70+50	130	GL50707050G	GL50707050GN	GL50707050GBL	722
239,5-245,5	60+65+65+60	120	GL60656560G	GL60656560GN	GL60656560GBL	740
249,5-255,5	50+80+80+50	150	GL50808050G	GL50808050GN	GL50808050GBL	746
249,5-255,5	60+70+70+60	130	GL60707060G	GL60707060GN	GL60707060GBL	750
269,5-275,5	60+80+80+60	150	GL60808060G	GL60808060GN	GL60808060GBL	774

*Permite uso perfil compensación en ambos lados en acabados cromo y negro.

*Permite combinación con Lateral fijo STD en acabados cromo y negro, rango mínimo +0,7 / expansión 3 cm (ver pág. 198)

PASO 2 - Selección soporte

Descripción	CROMO	NEGRO	BLANCO	P.
Brazo sujeción ajustable 60 cm	1715+1715	1715N+1715N	1715B+1715B	60
Barra 200 cm con 2 soportes (solo hasta 2 metros)	1717	9027	1717BL	60

Descripción	CROMO	NEGRO	BLANCO	Puntos
Perfil compensación +2 cm lado fijo	0218	9016	0218BL	35
Perfil compensación +4 cm lado fijo	0029			45
Imán expansión +1,2 cm (ver pág. 295)		1221		24

GLASS COMBI G Fijo + 2 puertas abatibles + fijo



Paneles fijos y puertas a medida ver pág. 289

PASO 1 - Selección medida y color (fijo+pta+pta+fijo)

Rango	Medida F+P+P+F	Apert.	ORO	COBRE	NÍQUEL	TITANIO	Puntos
129,5-135,5	20+50+50+20	90	GL20505020GOR	GL20505020GCB	GL20505020GNK	GL20505020GT	714
129,5-135,5	25+45+45+25	80	GL25454525GOR	GL25454525GCB	GL25454525GNK	GL25454525GT	716
129,5-135,5	30+40+40+30	75	GL30404030GOR	GL30404030GCB	GL30404030GNK	GL30404030GT	718
139,5-145,5	25+50+50+25	90	GL25505025GOR	GL25505025GCB	GL25505025GNK	GL25505025GT	728
139,5-145,5	30+45+45+30	80	GL30454530GOR	GL30454530GCB	GL30454530GNK	GL30454530GT	730
139,5-145,5	40+35+35+40	65	GL40353540GOR	GL40353540GCB	GL40353540GNK	GL40353540GT	734
149,5-155,5	30+50+50+30	90	GL30505030GOR	GL30505030GCB	GL30505030GNK	GL30505030GT	742
149,5-155,5	40+40+40+40	70	GL40404040GOR	GL40404040GCB	GL40404040GNK	GL40404040GT	746
159,5-165,5	20+65+65+20	120	GL20656520GOR	GL20656520GCB	GL20656520GNK	GL20656520GT	754
159,5-165,5	40+45+45+40	80	GL40454540GOR	GL40454540GCB	GL40454540GNK	GL40454540GT	758
159,5-165,5	50+35+35+50	60	GL50353550GOR	GL50353550GCB	GL50353550GNK	GL50353550GT	762
169,5-175,5	20+70+70+20	130	GL20707020GOR	GL20707020GCB	GL20707020GNK	GL20707020GT	764
169,5-175,5	25+65+65+25	120	GL25656525GOR	GL25656525GCB	GL25656525GNK	GL25656525GT	768
169,5-175,5	40+50+50+40	90	GL40505040GOR	GL40505040GCB	GL40505040GNK	GL40505040GT	770
169,5-175,5	50+40+40+50	70	GL50404050GOR	GL50404050GCB	GL50404050GNK	GL50404050GT	774
179,5-185,5	25+70+70+25	130	GL25707025GOR	GL25707025GCB	GL25707025GNK	GL25707025GT	778
179,5-185,5	30+65+65+30	120	GL30656530GOR	GL30656530GCB	GL30656530GNK	GL30656530GT	782
179,5-185,5	50+45+45+50	80	GL50454550GOR	GL50454550GCB	GL50454550GNK	GL50454550GT	786
179,5-185,5	60+35+35+60	60	GL60353560GOR	GL60353560GCB	GL60353560GNK	GL60353560GT	790
189,5-195,5	20+80+80+20	150	GL20808020GOR	GL20808020GCB	GL20808020GNK	GL20808020GT	788
189,5-195,5	30+70+70+30	130	GL30707030GOR	GL30707030GCB	GL30707030GNK	GL30707030GT	792
189,5-195,5	50+50+50+50	90	GL50505050GOR	GL50505050GCB	GL50505050GNK	GL50505050GT	798
189,5-195,5	60+40+40+60	70	GL60404060GOR	GL60404060GCB	GL60404060GNK	GL60404060GT	802
199,5-205,5	25+80+80+25	150	GL25808025GOR	GL25808025GCB	GL25808025GNK	GL25808025GT	802
199,5-205,5	40+65+65+40	120	GL40656540GOR	GL40656540GCB	GL40656540GNK	GL40656540GT	810
199,5-205,5	60+45+45+60	80	GL60454560GOR	GL60454560GCB	GL60454560GNK	GL60454560GT	814
209,5-215,5	30+80+80+30	150	GL30808030GOR	GL30808030GCB	GL30808030GNK	GL30808030GT	816
209,5-215,5	40+70+70+40	130	GL40707040GOR	GL40707040GCB	GL40707040GNK	GL40707040GT	820
209,5-215,5	60+50+50+60	90	GL60505060GOR	GL60505060GCB	GL60505060GNK	GL60505060GT	826
219,5-225,5	50+65+65+50	120	GL50656550GOR	GL50656550GCB	GL50656550GNK	GL50656550GT	838
229,5-235,5	40+80+80+40	150	GL40808040GOR	GL40808040GCB	GL40808040GNK	GL40808040GT	844
229,5-235,5	50+70+70+50	130	GL50707050GOR	GL50707050GCB	GL50707050GNK	GL50707050GT	848
239,5-245,5	60+65+65+60	120	GL60656560GOR	GL60656560GCB	GL60656560GNK	GL60656560GT	866
249,5-255,5	50+80+80+50	150	GL50808050GOR	GL50808050GCB	GL50808050GNK	GL50808050GT	872
249,5-255,5	60+70+70+60	130	GL60707060GOR	GL60707060GCB	GL60707060GNK	GL60707060GT	876
269,5-275,5	60+80+80+60	150	GL60808060GOR	GL60808060GCB	GL60808060GNK	GL60808060GT	900

BISAGRAS

PASO 2 - Selección soporte

Descripción	ORO	COBRE	NÍQUEL	TITANIO	Puntos
Brazo sujeción ajustable 60 cm	1715OR+1715OR	1715CB+1715CB	1715NK+1715NK	1715T+1715T	80
Barra 200 cm con 2 soportes	1717OR	1717CB	1717NK	1717T	80

Descripción	ORO	COBRE	NÍQUEL	TITANIO	Puntos
Perfil compensación +2 cm lado fijo	0218OR	0218CB	0218NK	0218T	45
Imán expansión +1,2 cm (ver pág. 295)	1221				24

GLASS COMBI H Fijo + 2 puertas abatibles + fijo

GL3070C+ GL2050C+1715+1715



Cromo



Negro



Blanco



Cierre imán



Paneles fijos y puertas a medida ver pág. 289

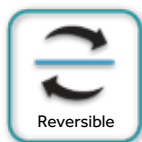

PASO 1 - Selección de 2 lados de la mampara

Rango	Fijo	Puerta	CROMO	NEGRO	BLANCO	Puntos
67-70	20	50	GL2050C	GL2050CN	GL2050CBL	294
72-75	25	50	GL2550C	GL2550CN	GL2550CBL	301
77-80	30	50	GL3050C	GL3050CN	GL3050CBL	308
82-85	20	65	GL2065C	GL2065CN	GL2065CBL	314
87-90	25	65	GL2565C	GL2565CN	GL2565CBL	321
87-90	20	70	GL2070C	GL2070CN	GL2070CBL	319
87-90	40	50	GL4050C	GL4050CN	GL4050CBL	322
92-95	25	70	GL2570C	GL2570CN	GL2570CBL	326
92-95	30	65	GL3065C	GL3065CN	GL3065CBL	328
97-100	30	70	GL3070C	GL3070CN	GL3070CBL	333
97-100	50	50	GL5050C	GL5050CN	GL5050CBL	336
97-100	20	80	GL2080C	GL2080CN	GL2080CBL	331
102-105	25	80	GL2580C	GL2580CN	GL2580CBL	338
102-105	40	65	GL4065C	GL4065CN	GL4065CBL	342
107-110	30	80	GL3080C	GL3080CN	GL3080CBL	345
107-110	40	70	GL4070C	GL4070CN	GL4070CBL	347
107-110	60	50	GL6050C	GL6050CN	GL6050CBL	350
112-115	50	65	GL5065C	GL5065CN	GL5065CBL	356
117-120	40	80	GL4080C	GL4080CN	GL4080CBL	359
117-120	50	70	GL5070C	GL5070CN	GL5070CBL	361
122-125	60	65	GL6065C	GL6065CN	GL6065CBL	370
127-130	50	80	GL5080C	GL5080CN	GL5080CBL	373
127-130	60	70	GL6070C	GL6070CN	GL6070CBL	375
137-140	60	80	GL6080C	GL6080CN	GL6080CBL	387

*Ejemplo: 120 (40+80) X 80 (30+50) + brazos negro = GL4080CN + GL3050CN + 1715N + 1715N

PASO 2 - Selección soporte

Descripción	CROMO	NEGRO	BLANCO	Puntos
Brazos sujeción ajustable 60 cm	1715+1715	1715N+1715N	1715B+1715B	60
Barras hasta 140 cm con un soporte	1716+1716+1730			103



Descripción	CROMO	NEGRO	BLANCO	Puntos
Perfil compensación +2 cm lado fijo	0218	9016	0218BL	35
Perfil compensación +4 cm lado fijo	0029			45
Imán expansión +1,2 cm (ver pág. 295)		1221		24

GLASS COMBI H Fijo + 2 puertas abatibles + fijo

GL3070COR+ GL2050COR+ 1715OR+1715OR



Oro



Cobre



Níquel



Titanio



Cierre imán



Paneles fijos y puertas a medida ver pág. 289

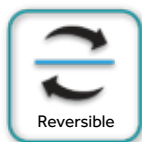

PASO 1 - Selección de 2 lados de la mampara

Rango	Fijo	Puerta	ORO	COBRE	NÍQUEL	TITANIO	Puntos
67-70	20	50	GL2050COR	GL2050CCB	GL2050CNK	GL2050CT	357
72-75	25	50	GL2550COR	GL2550CCB	GL2550CNK	GL2550CT	364
77-80	30	50	GL3050COR	GL3050CCB	GL3050CNK	GL3050CT	371
82-85	20	65	GL2065COR	GL2065CCB	GL2065CNK	GL2065CT	377
87-90	25	65	GL2565COR	GL2565CCB	GL2565CNK	GL2565CT	384
87-90	20	70	GL2070COR	GL2070CCB	GL2070CNK	GL2070CT	382
87-90	40	50	GL4050COR	GL4050CCB	GL4050CNK	GL4050CT	385
92-95	25	70	GL2570COR	GL2570CCB	GL2570CNK	GL2570CT	389
92-95	30	65	GL3065COR	GL3065CCB	GL3065CNK	GL3065CT	391
97-100	30	70	GL3070COR	GL3070CCB	GL3070CNK	GL3070CT	396
97-100	50	50	GL5050COR	GL5050CCB	GL5050CNK	GL5050CT	399
97-100	20	80	GL2080COR	GL2080CCB	GL2080CNK	GL2080CT	394
102-105	25	80	GL2580COR	GL2580CCB	GL2580CNK	GL2580CT	401
102-105	40	65	GL4065COR	GL4065CCB	GL4065CNK	GL4065CT	405
107-110	30	80	GL3080COR	GL3080CCB	GL3080CNK	GL3080CT	408
107-110	40	70	GL4070COR	GL4070CCB	GL4070CNK	GL4070CT	410
107-110	60	50	GL6050COR	GL6050CCB	GL6050CNK	GL6050CT	413
112-115	50	65	GL5065COR	GL5065CCB	GL5065CNK	GL5065CT	419
117-120	40	80	GL4080COR	GL4080CCB	GL4080CNK	GL4080CT	422
117-120	50	70	GL5070COR	GL5070CCB	GL5070CNK	GL5070CT	424
122-125	60	65	GL6065COR	GL6065CCB	GL6065CNK	GL6065CT	433
127-130	50	80	GL5080COR	GL5080CCB	GL5080CNK	GL5080CT	436
127-130	60	70	GL6070COR	GL6070CCB	GL6070CNK	GL6070CT	438
137-140	60	80	GL6080COR	GL6080CCB	GL6080CNK	GL6080CT	450

Ejemplo: 70 (20+50) x 70 (20+50) oro = GL2050OR + GL2050OR + 1715OR+1715OR

PASO 2 - Selección soporte

Descripción	ORO	COBRE	NÍQUEL	TITANIO	P.
Brazo sujeción ajustable 60 cm	1715OR+1715OR	1715CB+1715CB	1715NK+1715NK	1715T+1715T	80

Descripción	ORO	COBRE	NÍQUEL	TITANIO	Puntos
Perfil compensación +2 cm lado fijo	0218OR	0218CB	0218NK	0218T	45
Imán expansión +1,2 cm (ver pág. 295)	1221				24

GLASS COMBI | 2 puertas abatibles



Rango	Puerta	Puerta	Apert.	CROMO	NEGRO	BLANCO	Puntos
83-87	40	40	70	GL4040I	GL4040IN	GL4040IBL	502
88-92	40	45	75	GL4045I	GL4045IN	GL4045IBL	508
93-97	45	45	80	GL4545I	GL4545IN	GL4545IBL	514
98-102	45	50	85	GL4550I	GL4550IN	GL4550IBL	520
103-107	50	50	90	GL5050I	GL5050IN	GL5050IBL	526
118-122	50	65	105	GL5065I	GL5065IN	GL5065IBL	546
133-137	65	65	120	GL6565I	GL6565IN	GL6565IBL	566
138-142	65	70	125	GL6570I	GL6570IN	GL6570IBL	571
143-147	70	70	130	GL7070I	GL7070IN	GL7070IBL	576
153-157	70	80	140	GL7080I	GL7080IN	GL7080IBL	588
163-167	80	80	150	GL8080I	GL8080IN	GL8080IBL	600

*Se puede instalar también con bisagra a pared, se reduce el rango 3,1cm de cada lado donde se instale

Descripción	Ref.	Puntos
Imán expansión +1,2 cm (ver pág. 295)	1221	24

GLASS COMBI I 2 puertas abatibles



BISAGRAS

Rango	Puerta	Puerta	Apert.	ORO	COBRE	NÍQUEL	TITANIO	Puntos
83-87	40	40	70	GL4040IOR	GL4040ICB	GL4040INK	GL4040IT	610
88-92	40	45	75	GL4045IOR	GL4045ICB	GL4045INK	GL4045IT	616
93-97	45	45	80	GL4545IOR	GL4545ICB	GL4545INK	GL4545IT	622
98-102	45	50	85	GL4550IOR	GL4550ICB	GL4550INK	GL4550IT	628
103-107	50	50	90	GL5050IOR	GL5050ICB	GL5050INK	GL5050IT	634
118-122	50	65	105	GL5065IOR	GL5065ICB	GL5065INK	GL5065IT	654
133-137	65	65	120	GL6565IOR	GL6565ICB	GL6565INK	GL6565IT	674
138-142	65	70	125	GL6570IOR	GL6570ICB	GL6570INK	GL6570IT	679
143-147	70	70	130	GL7070IOR	GL7070ICB	GL7070INK	GL7070IT	684
153-157	70	80	140	GL7080IOR	GL7080ICB	GL7080INK	GL7080IT	696
163-167	80	80	150	GL8080IOR	GL8080ICB	GL8080INK	GL8080IT	708

*Se puede instalar también con bisagra a pared, se reduce el rango 3,1cm de cada lado donde se instale

Descripción	Ref.	Puntos
Imán expansión +1,2 cm (ver pág. 295)	1221	24

GLASS COMBI K 2 puertas abatibles al vértice



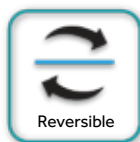

Rango	Puerta	Puerta	CROMO	NEGRO	BLANCO	Puntos
43,5-45,5/43,5-45,5	40	40	GL4040K	GL4040KN	GL4040KBL	502
48,5-50,5/43,5-45,5	45	40	GL4540K	GL4540KN	GL4540KBL	508
53,5-55,5/43,5-45,5	50	40	GL5040K	GL5040KN	GL5040KBL	514
68,5-70,5/43,5-45,5	65	40	GL6540K	GL6540KN	GL6540KBL	534
73,5-75,5/43,5-45,5	70	40	GL7040K	GL7040KN	GL7040KBL	539
83,5-85,5/43,5-45,5	80	40	GL8040K	GL8040KN	GL8040KBL	551
43,5-45,5/48,5-50,5	40	45	GL4045K	GL4045KN	GL4045KBL	508
48,5-50,5/48,5-50,5	45	45	GL4545K	GL4545KN	GL4545KBL	514
53,5-55,5/48,5-50,5	50	45	GL5045K	GL5045KN	GL5045KBL	520
68,5-70,5/48,5-50,5	65	45	GL6545K	GL6545KN	GL6545KBL	540
73,5-75,5/48,5-50,5	70	45	GL7045K	GL7045KN	GL7045KBL	545
83,5-85,5/48,5-50,5	80	45	GL8045K	GL8045KN	GL8045KBL	557
43,5-45,5/53,5-55,5	40	50	GL4050K	GL4050KN	GL4050KBL	514
48,5-50,5/53,5-55,5	45	50	GL4550K	GL4550KN	GL4550KBL	520
53,5-55,5/53,5-55,5	50	50	GL5050K	GL5050KN	GL5050KBL	526
68,5-70,5/53,5-55,5	65	50	GL6550K	GL6550KN	GL6550KBL	546
73,5-75,5/53,5-55,5	70	50	GL7050K	GL7050KN	GL7050KBL	551
83,5-85,5/53,5-55,5	80	50	GL8050K	GL8050KN	GL8050KBL	563
43,5-45,5/68,5-70,5	40	65	GL4065K	GL4065KN	GL4065KBL	534
48,5-50,5/68,5-70,5	45	65	GL4565K	GL4565KN	GL4565KBL	540
53,5-55,5/68,5-70,5	50	65	GL5065K	GL5065KN	GL5065KBL	546
68,5-70,5/68,5-70,5	65	65	GL6565K	GL6565KN	GL6565KBL	566
73,5-75,5/68,5-70,5	70	65	GL7065K	GL7065KN	GL7065KBL	571
83,5-85,5/68,5-70,5	80	65	GL8065K	GL8065KN	GL8065KBL	583
43,5-45,5/73,5-75,5	40	70	GL4070K	GL4070KN	GL4070KBL	539
48,5-50,5/73,5-75,5	45	70	GL4570K	GL4570KN	GL4570KBL	545
53,5-55,5/73,5-75,5	50	70	GL5070K	GL5070KN	GL5070KBL	551
68,5-70,5/73,5-75,5	65	70	GL6570K	GL6570KN	GL6570KBL	571
73,5-75,5/73,5-75,5	70	70	GL7070K	GL7070KN	GL7070KBL	576
83,5-85,5/73,5-75,5	80	70	GL8070K	GL8070KN	GL8070KBL	588
43,5-45,5/83,5-85,5	40	80	GL4080K	GL4080KN	GL4080KBL	551
48,5-50,5/83,5-85,5	45	80	GL4580K	GL4580KN	GL4580KBL	557
53,5-55,5/83,5-85,5	50	80	GL5080K	GL5080KN	GL5080KBL	563
68,5-70,5/83,5-85,5	65	80	GL6580K	GL6580KN	GL6580KBL	583
73,5-75,5/83,5-85,5	70	80	GL7080K	GL7080KN	GL7080KBL	588
83,5-85,5/83,5-85,5	80	80	GL8080K	GL8080KN	GL8080KBL	600

*Se puede instalar también con bisagra a pared, se reduce el rango 3,1cm de cada lado donde se instale

*Permite uso perfil compensación en ambos lados en acabados cromo y negro.

Descripción	CROMO	NEGRO	BLANCO	Puntos
Perfil compensación +2 cm lado fijo	0218	9016	0218BL	35
Perfil compensación +4 cm lado fijo	0029			45
Imán expansión +1,2 cm (ver pág. 295)	1221			24

GLASS COMBI K 2 puertas abatibles al vértice



Oro



Cobre



Níquel



Titanio



Cierre imán



Paneles fijos y puertas a medida ver pág. 289



Rango	Puerta	Puerta	ORO	COBRE	NÍQUEL	TITANIO	Puntos
43,5-45,5/43,5-45,5	40	40	GL4040KOR	GL4040KCB	GL4040KNK	GL4040KT	610
48,5-50,5/43,5-45,5	45	40	GL4540KOR	GL4540KCB	GL4540KNK	GL4540KT	616
53,5-55,5/43,5-45,5	50	40	GL5040KOR	GL5040KCB	GL5040KNK	GL5040KT	622
68,5-70,5/43,5-45,5	65	40	GL6540KOR	GL6540KCB	GL6540KNK	GL6540KT	642
73,5-75,5/43,5-45,5	70	40	GL7040KOR	GL7040KCB	GL7040KNK	GL7040KT	647
83,5-85,5/43,5-45,5	80	40	GL8040KOR	GL8040KCB	GL8040KNK	GL8040KT	659
43,5-45,5/48,5-50,5	40	45	GL4045KOR	GL4045KCB	GL4045KNK	GL4045KT	616
48,5-50,5/48,5-50,5	45	45	GL4545KOR	GL4545KCB	GL4545KNK	GL4545KT	622
53,5-55,5/48,5-50,5	50	45	GL5045KOR	GL5045KCB	GL5045KNK	GL5045KT	628
68,5-70,5/48,5-50,5	65	45	GL6545KOR	GL6545KCB	GL6545KNK	GL6545KT	648
73,5-75,5/48,5-50,5	70	45	GL7045KOR	GL7045KCB	GL7045KNK	GL7045KT	653
83,5-85,5/48,5-50,5	80	45	GL8045KOR	GL8045KCB	GL8045KNK	GL8045KT	665
43,5-45,5/53,5-55,5	40	50	GL4050KOR	GL4050KCB	GL4050KNK	GL4050KT	622
48,5-50,5/53,5-55,5	45	50	GL4550KOR	GL4550KCB	GL4550KNK	GL4550KT	628
53,5-55,5/53,5-55,5	50	50	GL5050KOR	GL5050KCB	GL5050KNK	GL5050KT	634
68,5-70,5/53,5-55,5	65	50	GL6550KOR	GL6550KCB	GL6550KNK	GL6550KT	654
73,5-75,5/53,5-55,5	70	50	GL7050KOR	GL7050KCB	GL7050KNK	GL7050KT	659
83,5-85,5/53,5-55,5	80	50	GL8050KOR	GL8050KCB	GL8050KNK	GL8050KT	671
43,5-45,5/68,5-70,5	40	65	GL4065KOR	GL4065KCB	GL4065KNK	GL4065KT	642
48,5-50,5/68,5-70,5	45	65	GL4565KOR	GL4565KCB	GL4565KNK	GL4565KT	648
53,5-55,5/68,5-70,5	50	65	GL5065KOR	GL5065KCB	GL5065KNK	GL5065KT	654
68,5-70,5/68,5-70,5	65	65	GL6565KOR	GL6565KCB	GL6565KNK	GL6565KT	674
73,5-75,5/68,5-70,5	70	65	GL7065KOR	GL7065KCB	GL7065KNK	GL7065KT	679
83,5-85,5/68,5-70,5	80	65	GL8065KOR	GL8065KCB	GL8065KNK	GL8065KT	691
43,5-45,5/73,5-75,5	40	70	GL4070KOR	GL4070KCB	GL4070KNK	GL4070KT	647
48,5-50,5/73,5-75,5	45	70	GL4570KOR	GL4570KCB	GL4570KNK	GL4570KT	653
53,5-55,5/73,5-75,5	50	70	GL5070KOR	GL5070KCB	GL5070KNK	GL5070KT	659
68,5-70,5/73,5-75,5	65	70	GL6570KOR	GL6570KCB	GL6570KNK	GL6570KT	679
73,5-75,5/73,5-75,5	70	70	GL7070KOR	GL7070KCB	GL7070KNK	GL7070KT	684
83,5-85,5/73,5-75,5	80	70	GL8070KOR	GL8070KCB	GL8070KNK	GL8070KT	696
43,5-45,5/83,5-85,5	40	80	GL4080KOR	GL4080KCB	GL4080KNK	GL4080KT	659
48,5-50,5/83,5-85,5	45	80	GL4580KOR	GL4580KCB	GL4580KNK	GL4580KT	665
53,5-55,5/83,5-85,5	50	80	GL5080KOR	GL5080KCB	GL5080KNK	GL5080KT	671
68,5-70,5/83,5-85,5	65	80	GL6580KOR	GL6580KCB	GL6580KNK	GL6580KT	691
73,5-75,5/83,5-85,5	70	80	GL7080KOR	GL7080KCB	GL7080KNK	GL7080KT	696
83,5-85,5/83,5-85,5	80	80	GL8080KOR	GL8080KCB	GL8080KNK	GL8080KT	708

*Se puede instalar también con bisagra a pared, se reduce el rango 3,1cm de cada lado donde se instale

*Permite uso perfil compensación en ambos lados.

Descripción	ORO	COBRE	NÍQUEL	TITANIO	Puntos
Perfil compensación +2 cm lado fijo	0218OR	0218CB	0218NK	0218T	45
Imán expansión +1,2 cm (ver pág. 295)	1221				24



Regístrate



Más información

Configuración de mamparas

Descubre nuestro Configurador de Mamparas disponible desde nuestro B2B, una herramienta intuitiva y visual diseñada para facilitar la selección y personalización de tus mamparas. Con este configurador, podrás elegir de manera sencilla y precisa las medidas, el modelo, el color y los acabados de cristales, asegurando que cada detalle se ajuste a tus necesidades y preferencias.

Características del Configurador:

- **Selección Visual:** Escoge las medidas, el modelo, el color y los acabados de cristales de forma visual y fácil.
- **Evita errores:** Reduce los errores en la transmisión de pedidos manuales gracias a su interfaz intuitiva.
- **Acceso Online:** Disponible en cualquier momento y lugar, para que puedas realizar tus configuraciones cuando lo necesites.

Optimiza tu proceso de selección y asegura la precisión de tus pedidos con nuestro Configurador de Mamparas.



Disponible para modelos:

BASIC 1F+1P+1F



OPEN



GLASS



PROGRAMA MODULAR GLASS

FIJOS (solo cristal)

FIJOS	Rango	Ref.	Puntos
FIJO 20	17-20	1700	36
FIJO 25	22-25	1701	43
FIJO 30	27-30	1702	50
FIJO 40	37-40	1703	64
FIJO 50	47-50	1704	78
FIJO 60	57-60	1705	92

PUERTAS (solo cristal)

PUERTAS	Medida	Ref.	Puntos
PUERTA 30	30	1725	52
PUERTA 35	35	1727	58
PUERTA 40	40	1726	64
PUERTA 45	45	1728	70
PUERTA 50	50	1706	76
PUERTA 65	65	1707	96
PUERTA 70	70	1708	101
PUERTA 80	80	1709	113

HERRAJES PUERTA GLASS CON BISAGRA A PARED

ACABADO	Ref.	Punto
● CROMO	1738	187
● NEGRO	1738N	187
● BLANCO	1738BL	187
● ORO	1738OR	241
● COBRE	1738CB	241
● NÍQUEL	1738NK	241
● TITANIO	1738T	241

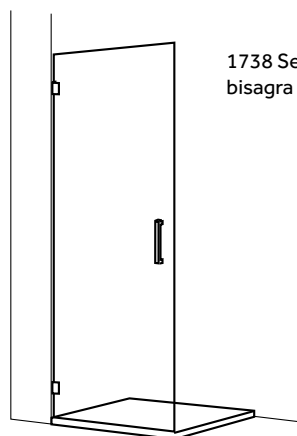

HERRAJES PUERTA GLASS CON BISAGRA A FIJO

ACABADO	Ref.	Punto
● CROMO	1737	182
● NEGRO	1737N	182
● BLANCO	1737BL	182
● ORO	1737OR	245
● COBRE	1737CB	245
● NÍQUEL	1737NK	245
● TITANIO	1737T	245

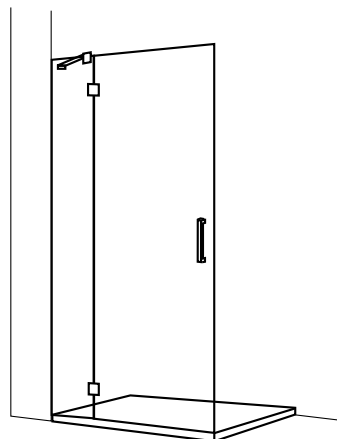

Laterales Fijos 6 mm

Descripción	Ref.	Puntos
Cristal lateral fijo 70	1760	110
Cristal lateral fijo 80	1761	120
Cristal lateral fijo 90	1762	130
Descripción	Ref.	Puntos
Perfil de pared cromo	5429	35
Perfil de pared negro	5477	35
Perfil de pared blanco	5473	35
Perfil de pared oro	5474	45
Perfil de pared cobre	5476	45
Perfil de pared níquel	5475	45
Perfil de pared titanio	5478	45

GME

GLASS PLEGABLE pg.244
1 panel + 1 puerta plegables



SPAZIO pg.244
1 puerta deslizando



AKORD pg.250
2 puertas plegables

TANDEM pg.248
Plegable + fijo y corredera



PLEGABLES

**H195**

Altura

**6mm**

Grosor cristal



Plegable



Magnético

**1.5cm**

Combi 1

**2.5/1.5cm**

Combi 2



Reversible

aluminio
AL
aluminium

Clear shield glass

GLASS PLEGABLE



COMBI 1 con cierre imán a pared

Medidas	Rango	Referencias	Puntos
60 (30+30)	57,5-59	1712+1725	342
70 (40+30)	67,5-69	1713+1725	355
75 (40+35)	72,5-74	1713+1727	361
80 (40+40)	77,5-79	1713+1726	367
80 (50+30)	77,5-79	1714+1725	367
85 (50+35)	82,5-84	1714+1727	373
90 (50+40)	87,5-89	1714+1726	379
95 (50+45)	92,5-94	1714+1728	385
100 (50+50)	97,5-99	1714+1706	391

Permite combinación con lateral fijo Glass en lado puerta, el rango del frontal se reducirá en 0,5 cm

Descripción	Ref.	Puntos
Perfil puerta (reduce hasta 1 cm el rango)	1215	25
Perfil expansión +2,5 cm	1222	48
Imanes de expansión +1,2 cm	1221	24



Opción puertas a medida (ver pág. 289)

Descripción	Ref.	Puntos
Puerta < 80 cm	1338	150

COMBI 2 con cierre perfil imán

Medida	Rango	Referencias	Puntos
65 (30+30)	60-64	1712+1725+1212	402
75 (40+30)	70-74	1713+1725+1212	415
80 (40+35)	75-79	1713+1727+1212	421
85 (40+40)	80-84	1713+1726+1212	427
85 (50+30)	80-84	1714+1725+1212	427
90 (50+35)	85-89	1714+1727+1212	433
95 (50+40)	90-94	1714+1726+1212	439
100 (50+45)	95-99	1714+1728+1212	445
105 (50+50)	100-104	1714+1706+1212	451

Permite combinación con Lateral fijo STD en lado puerta, el rango mínimo el frontal aumenta 0,7 cm

Descripción	Ref.	Puntos
Perfil puerta (reduce hasta 1 cm el rango)	1215	25
Perfil expansión lado cristal +2,5 cm	1222	48
Imanes de expansión +1,2 cm	1221	24
Perfil exp. lado cierre perfil imán (+3 cm)	0218	35
Perfil exp. lado cierre perfil imán (+6 cm)	0029	45

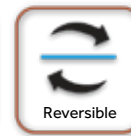

GLASS PLEGABLE NEGRA



COMBI 1 con cierre imán a pared

Medidas	Rango	Referencias	Puntos
60 (30+30)	57,5-59	1712N+1725	362
70 (40+30)	67,5-69	1713N+1725	375
75 (40+35)	72,5-74	1713N+1727	381
80 (40+40)	77,5-79	1713N+1726	387
80 (50+30)	77,5-79	1714N+1725	387
85 (50+35)	82,5-84	1714N+1727	393
90 (50+40)	87,5-89	1714N+1726	399
95 (50+45)	92,5-94	1714N+1728	405
100 (50+50)	97,5-99	1714N+1706	411

Permite combinación con lateral fijo Glass en lado puerta, el rango del frontal se reducirá en 0,5 cm

Descripción	Ref.	Puntos
Perfil puerta (reduce hasta 1 cm el rango)	9014	25
Perfil expansión +2,5 cm	9015	48
Imanes de expansión +1,2 cm	1221	24

COMBI 2 con cierre perfil imán

Medida	Rango	Referencias	Puntos
65 (30+30)	60-64	1712N+1725+9013	422
75 (40+30)	70-74	1713N+1725+9013	435
80 (40+35)	75-79	1713N+1727+9013	441
85 (40+40)	80-84	1713N+1726+9013	447
85 (50+30)	80-84	1714N+1725+9013	447
90 (50+35)	85-89	1714N+1727+9013	453
95 (50+40)	90-94	1714N+1726+9013	459
100 (50+45)	95-99	1714N+1728+9013	465
105 (50+50)	100-104	1714N+1706+9013	471

Permite combinación con Lateral fijo STD en lado puerta, el rango mínimo el frontal aumenta 0,7 cm

Descripción	Ref.	Puntos
Perfil puerta (reduce hasta 1 cm el rango)	9014	25
Perfil expansión lado cristal +2,5 cm	9015	48
Imanes de expansión +1,2 cm	1221	24
Perfil exp. lado cierre perfil imán (+3 cm)	9016	35



Opción puertas a medida (ver pág. 289)

Descripción	Ref.	Puntos
Puerta < 80 cm	1338	150

GLASS PLEGABLE + lat. fijo



COMBI 1 + LATERAL FIJO 70 c/BRAZO 1715

Medidas	Rango	Referencias	Puntos
60 (30+30)x70	57-58,5/66-69	1712+1725+1720F+1715	538
70 (40+30)x70	67-68,5/66-69	1713+1725+1720F+1715	551
75 (40+35)x70	72-73,5/66-69	1713+1727+1720F+1715	557
80 (40+40)x70	77-78,5/66-69	1713+1726+1720F+1715	563
80 (50+30)x70	77-78,5/66-69	1714+1725+1720F+1715	563
85 (50+35)x70	82-83,5/66-69	1714+1727+1720F+1715	569
90 (50+40)x70	87-88,5/66-69	1714+1726+1720F+1715	575
95 (50+45)x70	92-93,5/66-69	1714+1728+1720F+1715	581
100 (50+50)x70	97-98,5/66-69	1714+1706+1720F+1715	587

COMBI 1 + LATERAL FIJO 80 c/BRAZO 1715

Medidas	Rango	Referencias	Puntos
60 (30+30)x80	57-58,5/76-79	1712+1725+1721F+1715	550
70 (40+30)x80	67-68,5/76-79	1713+1725+1721F+1715	563
75 (40+35)x80	72-73,5/76-79	1713+1727+1721F+1715	569
80 (40+40)x80	77-78,5/76-79	1713+1726+1721F+1715	575
80 (50+30)x80	77-78,5/76-79	1714+1725+1721F+1715	575
85 (50+35)x80	82-83,5/76-79	1714+1727+1721F+1715	581
90 (50+40)x80	87-88,5/76-79	1714+1726+1721F+1715	587
95 (50+45)x80	92-93,5/76-79	1714+1728+1721F+1715	593
100 (50+50)x80	97-98,5/76-79	1714+1706+1721F+1715	599

COMBI 1 + LATERAL FIJO 90 c/BRAZO 1715

Medidas	Rango	Referencias	Puntos
60 (30+30)x90	57-58,5/86-89	1712+1725+1722F+1715	562
70 (40+30)x90	67-68,5/86-89	1713+1725+1722F+1715	575
75 (40+35)x90	72-73,5/86-89	1713+1727+1722F+1715	581
80 (40+40)x90	77-78,5/86-89	1713+1726+1722F+1715	587
80 (50+30)x90	77-78,5/86-89	1714+1725+1722F+1715	587
85 (50+35)x90	82-83,5/86-89	1714+1727+1722F+1715	593
90 (50+40)x90	87-88,5/86-89	1714+1726+1722F+1715	599
95 (50+45)x90	92-93,5/86-89	1714+1728+1722F+1715	605
100 (50+50)x90	97-98,5/86-89	1714+1706+1722F+1715	611

Laterales fijos GLASS PLEGABLE 6 mm

Descripción	Rango	Ref.	Puntos
Lateral fijo 70	66 - 69	1720F	166
Lateral fijo 80	76 - 79	1721F	178
Lateral fijo 90	86 - 89	1722F	190

Descripción	Ref.	Puntos
Perfil compensación +2 cm	0218	25
Perfil compensación +4 cm	0029	35

Opcion brazo

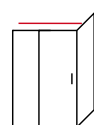

Barra 140 con soporte
ref. 1716+1718
(sustituir la ref. 1715)

Puntos

60



Laterales fijos a medida 6 mm (más información en página 291)

Descripción	Referencias	Puntos	Cajonado
Lateral fijo a medida GLASS PLEGABLE hasta 40 cm	1380	207	+21
Lateral fijo a medida GLASS PLEGABLE de 40 hasta 80 cm	1381	282	+21
Lateral fijo a medida GLASS PLEGABLE de 80 hasta 120 cm	1382	352	+21

*Plazo de entrega 15 días

GLASS PLEGABLE NEGRA + lat. fijo



COMBI 1 + LATERAL FIJO 70 c/BRAZO 1715N

Medidas	Rango	Referencias	Puntos
60 (30+30)x70	57-58,5/66-69	1712N+1725+1720FN+1715N	568
70 (40+30)x70	67-68,5/66-69	1713N+1725+1720FN+1715N	581
75 (40+35)x70	72-73,5/66-69	1713N+1727+1720FN+1715N	587
80 (40+40)x70	77-78,5/66-69	1713N+1726+1720FN+1715N	593
80 (50+30)x70	77-78,5/66-69	1714N+1725+1720FN+1715N	593
85 (50+35)x70	82-83,5/66-69	1714N+1727+1720FN+1715N	599
90 (50+40)x70	87-88,5/66-69	1714N+1726+1720FN+1715N	605
95 (50+45)x70	92-93,5/66-69	1714N+1728+1720FN+1715N	611
100 (50+50)x70	97-98,5/66-69	1714N+1706+1720FN+1715N	617

COMBI 1 + LATERAL FIJO 80 c/BRAZO 1715N

Medidas	Rango	Referencias	Puntos
60 (30+30)x80	57-58,5/76-79	1712N+1725+1721FN+1715N	580
70 (40+30)x80	67-68,5/76-79	1713N+1725+1721FN+1715N	593
75 (40+35)x80	72-73,5/76-79	1713N+1727+1721FN+1715N	599
80 (40+40)x80	77-78,5/76-79	1713N+1726+1721FN+1715N	605
80 (50+30)x80	77-78,5/76-79	1714N+1725+1721FN+1715N	605
85 (50+35)x80	82-83,5/76-79	1714N+1727+1721FN+1715N	611
90 (50+40)x80	87-88,5/76-79	1714N+1726+1721FN+1715N	617
95 (50+45)x80	92-93,5/76-79	1714N+1728+1721FN+1715N	623
100 (50+50)x80	97-98,5/76-79	1714N+1706+1721FN+1715N	629

COMBI 1 + LATERAL FIJO 90 c/BRAZO 1715N

Medidas	Rango	Referencias	Puntos
60 (30+30)x90	57-58,5/86-89	1712N+1725+1722FN+1715N	592
70 (40+30)x90	67-68,5/86-89	1713N+1725+1722FN+1715N	605
75 (40+35)x90	72-73,5/86-89	1713N+1727+1722FN+1715N	611
80 (40+40)x90	77-78,5/86-89	1713N+1726+1722FN+1715N	617
80 (50+30)x90	77-78,5/86-89	1714N+1725+1722FN+1715N	617
85 (50+35)x90	82-83,5/86-89	1714N+1727+1722FN+1715N	623
90 (50+40)x90	87-88,5/86-89	1714N+1726+1722FN+1715N	629
95 (50+45)x90	92-93,5/86-89	1714N+1728+1722FN+1715N	635
100 (50+50)x90	97-98,5/86-89	1714N+1706+1722FN+1715N	641

Laterales fijos GLASS PLEGABLE NEGRA 6 mm

Descripción	Rango	Ref.	Puntos
Lateral fijo 70	66 - 69	1720FN	176
Lateral fijo 80	76 - 79	1721FN	188
Lateral fijo 90	86 - 89	1722FN	200

Descripción	Ref.	Puntos
Perfil compensación negro+2 cm	9016	35

Opcion brazo

Puntos

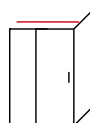

Barra 140 con soporte
ref. 9026+9028
(sustituir la ref. 1715N)

60



Laterales fijos a medida 6 mm (más información en página 291)

Descripción	Ref.	Puntos	Cajonado
Lat. fijo a medida GLASS PLEGABLE NEGRA hasta 40 cm	1380N	207	+21
Lat. fijo a medida GLASS PLEGABLE NEGRA de 40 hasta 80 cm	1381N	282	+21
Lat. fijo a medida GLASS PLEGABLE NEGRA de 80 hasta 120 cm	1382N	352	+21

*Plazo de entrega 15 días

AKORD

plegable



Frontales AKORD

Rango	Apertura	Referencias	Puntos
66-71	50	0830	429
76-81	60	0831	440
86-91	70	0832	452
96-101	80	0833	464

Descripción	Referencias	Puntos
Perfil compensación +2 cm	0218	35
Perfil compensación +4 cm	0029	45



Combinaciones AKORD + Lateral fijo STD

Rangos	Referencias	Puntos
66,4-68,9/66-69	0830+0814	624
76,4-78,9/66-69	0831+0814	635
86,4-88,9/66-69	0832+0814	647
96,4-98,9/66-69	0833+0814	659
Rangos	Referencias	Puntos
66,4-68,9/76-79	0830+0815	634
76,4-78,9/76-79	0831+0815	645
86,4-88,9/76-79	0832+0815	657
96,4-98,9/76-79	0833+0815	669

*Se puede combinar con fijos STD (ver pág. 198)

Descripción	Referencias	Puntos
Perfil compensación +2 cm	0218	35
Perfil compensación +4 cm	0029	45

Sistema de hojas plegables

SPAZIO COMBI A

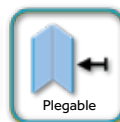

PLEGABLES

Medida	Apertura	Rango (cm)	CROMO		NEGRO	
			Referencia	Puntos	Referencia	Puntos
65	49	62,5-64	1260+1215	400	1260N+9014	405
65	49	63,5-65	1260+1211	400	1260N+9012	405
70	54	68-69,5	1261+1215	409	1261N+9014	414
70	54	69-70,5	1261+1211	409	1261N+9012	414
75	60	73,5-75	1262+1215	419	1262N+9014	424
75	60	74,5-76	1262+1211	419	1262N+9012	424

Descripción	Ref.	P.
Perfil expansión puerta cromo (+1cm sobre rango máx. + expansión 2,5cm)	1222	48
Perfil expansión puerta negro (+1cm sobre rango máx. + expansión 2,5cm)	9015	48



Ejemplo: combinación 1260+1211 (rango 63,5-65). Añadiendo perfil 1222 el nuevo rango será 66-68,5cm

El fondo deberá ser = ó > que el rango máximo del frontal

SPAZIO

COMBI A + Lateral fijo

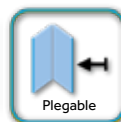

Medidas	Apert.	Rangos	CROMO		NEGRO	
			Referencia	Puntos	Referencia	Puntos
65x70	49	62,5-64/66,5-69	1260+1215+1263	561	1260N+9014+1263N	571
65x70	49	63,5-65/66,5-69	1260+1211+1263	561	1260N+9012+1263N	571
65x80	49	62,5-64/76,5-79	1260+1215+1264	576	1260N+9014+1264N	586
65x80	49	63,5-65/76,5-79	1260+1211+1264	576	1260N+9012+1264N	586
70x80	54	68-69,5/76,5-79	1261+1215+1264	585	1261N+9014+1264N	595
70x80	54	69-70,5/76,5-79	1261+1211+1264	585	1261N+9012+1264N	595
75x80	60	73,5-75/76,5-79	1262+1215+1264	595	1262N+9014+1264N	605
75x80	60	74,5-76/76,5-79	1262+1211+1264	595	1262N+9012+1264N	605
65x90	49	62,5-64/86,5-89	1260+1215+1265	590	1260N+9014+1265N	600
65x90	49	63,5-65/86,5-89	1260+1211+1265	590	1260N+9012+1265N	600
70x90	54	68-69,5/86,5-89	1261+1215+1265	599	1261N+9014+1265N	609
70x90	54	69-70,5/86,5-89	1261+1211+1265	599	1261N+9012+1265N	609
75x90	60	73,5-75/86,5-89	1262+1215+1265	609	1262N+9014+1265N	619
75x90	60	74,5-76/86,5-89	1262+1211+1265	609	1262N+9012+1265N	619

*Se puede instalar con fijo en ambos lados, consultar fábrica.

Descripción	Referencia	Puntos
Perfil expansión lateral fijo +3	0218	35
Perfil expansión lateral fijo +6	0029	45
Perfil expansión puerta cromo (+1cm sobre rango máx. + expansión 2,5cm)*	1222	48
Perfil expansión puerta negro (+1cm sobre rango máx. + expansión 2,5cm)*	9015	48

*Ejemplo: combinación 1260+1211 (rango 63,5-65). Añadiendo perfil 1222 el nuevo rango será 66-68,5cm

SPAZIO COMBI B

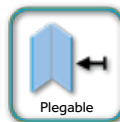

Medidas	Ap.	Rango	Fijo	Puerta	CROMO		NEGRO	
					Referencia	Puntos	Referencia	Puntos
85	49	79,5-82	20	65	1200+1260	465	9024+1260N	470
90	54	84,5-87	20	70	1200+1261	474	9024+1261N	479
90	49	84,5-87	25	65	1201+1260	472	9025+1260N	477
95	60	90-92,5	20	75	1200+1262	484	9024+1262N	489
95	54	90-92,5	25	70	1201+1261	481	9025+1261N	486
95	49	90-92,5	30	65	1202+1260	479	9000+1260N	484
100	60	95-97,5	25	75	1201+1262	491	9025+1262N	496
100	54	95-97,5	30	70	1202+1261	488	9000+1261N	493
105	49	100,5-103	40	65	1203+1260	495	9001+1260N	500
105	60	100,5-103	30	75	1202+1262	498	9000+1262N	503
110	54	105-107,5	40	70	1203+1261	504	9001+1261N	509
115	49	109,5-112	50	65	1204+1260	510	9002+1260N	515
115	60	109,5-112	40	75	1203+1262	514	9001+1262N	519
120	54	115-117,5	50	70	1204+1261	519	9002+1261N	524
125	49	120,5-123	60	65	1205+1260	525	9003+1260N	530
125	60	120,5-123	50	75	1204+1262	529	9002+1262N	534
125	54	125-127,5	60	70	1205+1261	534	9003+1261N	539
135	60	130,5-133	60	75	1205+1262	544	9003+1262N	549

Descripción	Referencia	Puntos
Perfil expansión lado fijo +3	0218	35
Perfil expansión lado fijo +6	0029	45

El fondo deberá ser = ó > que el rango máximo de la puerta

SPAZIO COMBI B + Lateral fijo





combinaciones frontales SPAZIO + lateral fijo

Medidas	Aperturas	Rango	Fijo	Puerta	Referencia	Puntos
85x70	49	79,5-82/66,5-69	20	65	1200+1260+1263	626
90x70	49	84,5-87/66,5-69	25	65	1201+1260+1263	633
95x70	49	90-92,5/66,5-69	30	65	1202+1260+1263	640
105x70	49	100,5-103/66,5-69	40	65	1203+1260+1263	656
115x70	49	109,5-112/66,5-69	50	65	1204+1260+1263	671
125x70	49	120,5-123/66,5-69	60	65	1205+1260+1263	686
85x80	49	79,5-82/76,5-79	20	65	1200+1260+1264	641
90x80	54	84,5-87/76,5-79	20	70	1200+1261+1264	650
90x80	49	84,5-87/76,5-79	25	65	1201+1260+1264	648
95x80	60	90-92,5/76,5-79	20	75	1200+1262+1264	660
95x80	54	90-92,5/76,5-79	25	70	1201+1261+1264	657
95x80	49	90-92,5/76,5-79	30	65	1202+1260+1264	655
100x80	60	95-97,5/76,5-79	25	75	1201+1262+1264	667
100x80	54	95-97,5/76,5-79	30	70	1202+1261+1264	664
105x80	49	100,5-103/76,5-79	40	65	1203+1260+1264	671
105x80	60	100,5-103/76,5-79	30	75	1202+1262+1264	674
110x80	54	105-107,5/76,5-79	40	70	1203+1261+1264	680
115x80	49	109,5-112/76,5-79	50	65	1204+1260+1264	686
115x80	60	109,5-112/76,5-79	40	75	1203+1262+1264	690
120x80	54	115-117,5/76,5-79	50	70	1204+1261+1264	695
125x80	49	120,5-123/76,5-79	60	65	1205+1260+1264	701
125x80	60	120,5-123/76,5-79	50	75	1204+1262+1264	705
130x80	54	125-127,5/76,5-79	60	70	1205+1261+1264	710
135x80	60	130,5-133/76,5-79	60	75	1205+1262+1264	720
85x90	49	79,5-82/86,5-89	20	65	1200+1260+1265	655
90x90	54	84,5-87/86,5-89	20	70	1200+1261+1265	664
90x90	49	84,5-87/86,5-89	25	65	1201+1260+1265	662
95x90	60	90-92,5/86,5-89	20	75	1200+1262+1265	674
95x90	54	90-92,5/86,5-89	25	70	1201+1261+1265	671
95x90	49	90-92,5/86,5-89	30	65	1202+1260+1265	669
100x90	60	95-97,5/86,5-89	25	75	1201+1262+1265	681
100x90	54	95-97,5/86,5-89	30	70	1202+1261+1265	678
105x90	49	100,5-103/86,5-89	40	65	1203+1260+1265	685
105x90	60	100,5-103/86,5-89	30	75	1202+1262+1265	688
110x90	54	105-107,5/86,5-89	40	70	1203+1261+1265	694
115x90	49	109,5-112/86,5-89	50	65	1204+1260+1265	700
115x90	60	109,5-112/86,5-89	40	75	1203+1262+1265	704
120x90	54	115-117,5/86,5-89	50	70	1204+1261+1265	709
125x90	49	120,5-123/86,5-89	60	65	1205+1260+1265	715
125x90	60	120,5-123/86,5-89	50	75	1204+1262+1265	719
130x90	54	125-127,5/86,5-89	60	70	1205+1261+1265	724
135x90	60	130,5-133/86,5-89	60	75	1205+1262+1265	734

*Se puede instalar con fijo en ambos lados, consultar fábrica.



Descripción	Referencia	Puntos
Laterales fijos a medida <40cm	1345SP	262
Laterales fijos a medida de 40cm hasta 90cm	1316SP	337
Laterales fijos a medida de >90cm hasta 120cm	1317SP	452

SPAZIO COMBI B + Lateral fijo negro



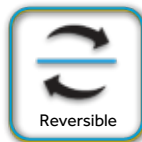
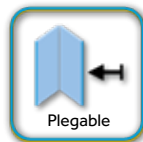

combinaciones frontales SPAZIO + lateral fijo

Medidas	Aperturas	Rango	Fijo	Puerta	Referencia	Puntos
85x70	49	79,5-82/66,5-69	20	65	9024+1260N+1263N	636
90x70	49	84,5-87/66,5-69	25	65	9025+1260N+1263N	643
95x70	49	90-92,5/66,5-69	30	65	9000+1260N+1263N	650
105x70	49	100,5-103/66,5-69	40	65	9001+1260N+1263N	666
115x70	49	109,5-112/66,5-69	50	65	9002+1260N+1263N	681
125x70	49	120,5-123/66,5-69	60	65	9003+1260N+1263N	696
85x80	49	79,5-82/76,5-79	20	65	9024+1260N+1264N	651
90x80	54	84,5-87/76,5-79	20	70	9024+1261N+1264N	660
90x80	49	84,5-87/76,5-79	25	65	9025+1260N+1264N	658
95x80	60	90-92,5/76,5-79	20	75	9024+1262N+1264N	670
95x80	54	90-92,5/76,5-79	25	70	9025+1261N+1264N	667
95x80	49	90-92,5/76,5-79	30	65	9000+1260N+1264N	665
100x80	60	95-97,5/76,5-79	25	75	9025+1262N+1264N	677
100x80	54	95-97,5/76,5-79	30	70	9000+1261N+1264N	674
105x80	49	100,5-103/76,5-79	40	65	9001+1260N+1264N	681
105x80	60	100,5-103/76,5-79	30	75	9000+1262N+1264N	684
110x80	54	105-107,5/76,5-79	40	70	9001+1261N+1264N	690
115x80	49	109,5-112/76,5-79	50	65	9002+1260N+1264N	696
115x80	60	109,5-112/76,5-79	40	75	9001+1262N+1264N	700
120x80	54	115-117,5/76,5-79	50	70	9002+1261N+1264N	705
125x80	49	120,5-123/76,5-79	60	65	9003+1260N+1264N	711
125x80	60	120,5-123/76,5-79	50	75	9002+1262N+1264N	715
130x80	54	125-127,5/76,5-79	60	70	9003+1261N+1264N	720
135x80	60	130,5-133/76,5-79	60	75	9003+1262N+1264N	730
85x90	49	79,5-82/86,5-89	20	65	9024+1260N+1265N	665
90x90	54	84,5-87/86,5-89	20	70	9024+1261N+1265N	674
90x90	49	84,5-87/86,5-89	25	65	9025+1260N+1265N	672
95x90	60	90-92,5/86,5-89	20	75	9024+1262N+1265N	684
95x90	54	90-92,5/86,5-89	25	70	9025+1261N+1265N	681
95x90	49	90-92,5/86,5-89	30	65	9000+1260N+1265N	679
100x90	60	95-97,5/86,5-89	25	75	9025+1262N+1265N	691
100x90	54	95-97,5/86,5-89	30	70	9000+1261N+1265N	688
105x90	49	100,5-103/86,5-89	40	65	9001+1260N+1265N	695
105x90	60	100,5-103/86,5-89	30	75	9000+1262N+1265N	698
110x90	54	105-107,5/86,5-89	40	70	9001+1261N+1265N	704
115x90	49	109,5-112/86,5-89	50	65	9002+1260N+1265N	710
115x90	60	109,5-112/86,5-89	40	75	9001+1262N+1265N	714
120x90	54	115-117,5/86,5-89	50	70	9002+1261N+1265N	719
125x90	49	120,5-123/86,5-89	60	65	9003+1260N+1265N	725
125x90	60	120,5-123/86,5-89	50	75	9002+1262N+1265N	729
130x90	54	125-127,5/86,5-89	60	70	9003+1261N+1265N	734
135x90	60	130,5-133/86,5-89	60	75	9003+1262N+1265N	744

*Se puede instalar con fijo en ambos lados, consultar fábrica.



Descripción	Referencia	Puntos
Laterales fijos a medida hasta <40cm	1345NSP	262
Laterales fijos a medida de 40cm hasta 90cm	1316NSP	337
Laterales fijos a medida de >90cm hasta 120cm	1317NSP	452

TANDEM fijo + corredera y plegable



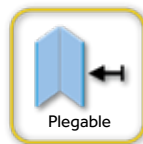
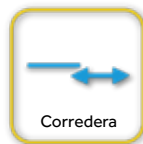

combinaciones TANDEM angular

F+CxPleg.	Ap.	Rangos	Referencias	Puntos	F+CxPleg.	Ap.	Rangos	Referencias	Puntos
70x70	59	63-68 / 66,5-69,5	5018+5423+1740	669	70x75	66	63-68 / 71,5-74,5	5018+5423+1743	675
75x70	59	68-73 / 66,5-69,5	5029+5423+1740	674	75x75	67	68-73 / 71,5-74,5	5029+5423+1743	680
80x70	61	73-78 / 66,5-69,5	5019+5423+1740	679	80x75	68	73-78 / 71,5-74,5	5019+5423+1743	685
85x70	63	78-83 / 66,5-69,5	5030+5423+1740	685	85x75	69	78-83 / 71,5-74,5	5030+5423+1743	691
90x70	64	83-88 / 66,5-69,5	5020+5423+1740	690	90x75	70	83-88 / 71,5-74,5	5020+5423+1743	696
95x70	66	88-93 / 66,5-69,5	5031+5423+1740	693	95x75	72	88-93 / 71,5-74,5	5031+5423+1743	699
100x70	67	93-98 / 66,5-69,5	5021+5423+1740	695	100x75	73	93-98 / 71,5-74,5	5021+5423+1743	701
110x70	68	102-107 / 66,5-69,5	5002+5423+1740	705	110x75	74	102-107 / 71,5-74,5	5002+5423+1743	711
120x70	73	113-118 / 66,5-69,5	5022+5423+1740	716	120x75	79	113-118 / 71,5-74,5	5022+5423+1743	722
130x70	74	122-127 / 66,5-69,5	5006+5424+1740	737	130x75	80	122-127 / 71,5-74,5	5006+5424+1743	743
140x70	78	132-137 / 66,5-69,5	5008+5424+1740	746	140x75	83	132-137 / 71,5-74,5	5008+5424+1743	752
F+CxPleg.	Ap.	Rangos	Referencias	Puntos	F+CxPleg.	Ap.	Rangos	Referencias	Puntos
70X80	68	63-68 / 76,5-79,5	5018+5423+1741	680	70X90	77	63-68 / 86,5-89,5	5018+5423+1742	691
75x80	68	68-73 / 76,5-79,5	5029+5423+1741	685	75x90	77	68-73 / 86,5-89,5	5029+5423+1742	696
80X80	70	73-78 / 76,5-79,5	5019+5423+1741	690	80x90	79	73-78 / 86,5-89,5	5019+5423+1742	701
85x80	71	78-83 / 76,5-79,5	5030+5423+1741	696	85x90	80	78-83 / 86,5-89,5	5030+5423+1742	707
90X80	72	83-88 / 76,5-79,5	5020+5423+1741	701	90X90	81	83-88 / 86,5-89,5	5020+5423+1742	712
95x80	74	88-93 / 76,5-79,5	5031+5423+1741	704	95x90	82	88-93 / 86,5-89,5	5031+5423+1742	715
100X80	75	93-98 / 76,5-79,5	5021+5423+1741	706	100X90	83	93-98 / 86,5-89,5	5021+5423+1742	717
110x80	76	102-107 / 76,5-79,5	5002+5423+1741	716	110x90	84	102-107 / 86,5-89,5	5002+5423+1742	727
120X80	81	113-118 / 76,5-79,5	5022+5423+1741	727	120X90	88	113-118 / 86,5-89,5	5022+5423+1742	738
130X80	82	122-127 / 76,5-79,5	5006+5424+1741	748	130x90	89	122-127 / 86,5-89,5	5006+5424+1742	759
140X80	85	132-137 / 76,5-79,5	5008+5424+1741	757	140X90	92	132-137 / 86,5-89,5	5008+5424+1742	768

Se pueden combinar con frontales Basic de medidas intermedias, rango +2 cm.

Descripción	Referencias	Puntos
Perfil compensación +1,5 cm para lado fijo + corredera	5429	35
Perfil compensación +2,5 para lado plegable	1222	48



Mamparas a medida y cristales especiales

Cajonado

Mamparas a medida +45%

+21

Se puede fabricar a medida el lado de fijo y corredera y la puerta del lado plegable con altura 195 cm.

*Plazo de entrega 15 días

GME

TRIO pg.256
1 fijo y 2 correderas



TRIO NEGRA pg.258
1 fijo y 2 correderas



BYPASS pg.260
2 correderas



PUERTAS DE PASO pg.262
Corredera



+SOLUCIONES

TRIO 1 fijo + 2 correderas

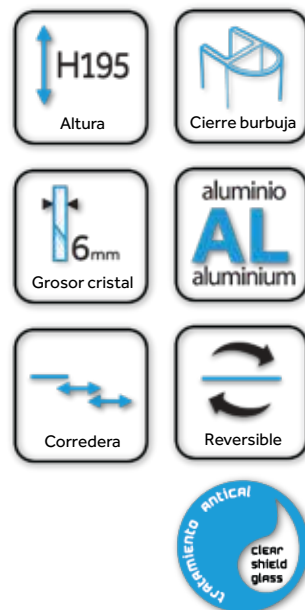

Pletina embellecedora

Descripción	Rango	Apertura	Referencias	Puntos
Frontal 1F+2C TRIO 90	86-91	43-45	1230	470
Frontal 1F+2C TRIO 95	91-96	46-48	1231	480
Frontal 1F+2C TRIO 100	96-101	49-51	1232	490
Frontal 1F+2C TRIO 105	101-106	53-55	1233	500
Frontal 1F+2C TRIO 110	106-111	56-58	1234	511
Frontal 1F+2C TRIO 115	111-116	59-61	1235	521
Frontal 1F+2C TRIO 120	116-121	63-65	1236	530
Frontal 1F+2C TRIO 125	121-126	66-68	1237	537
Frontal 1F+2C TRIO 130	126-131	69-71	1238	546
Frontal 1F+2C TRIO 135	131-136	73-75	1239	554
Frontal 1F+2C TRIO 140	136-141	76-78	1240	560
Frontal 1F+2C TRIO 145	141-146	79-81	1243	572
Frontal 1F+2C TRIO 150	146-151	82-84	1244	583
Frontal 1F+2C TRIO 155	151-156	85-88	1245	596
Frontal 1F+2C TRIO 160	156-161	89-91	1246	608
Pletina embellecedora 195x3,8 cm			0007	30

TRIO frontal + lateral fijo



Medidas	Rangos	Referencias	Puntos	Medidas	Rangos	Referencias	Puntos
90x70	87-89,5 / 67-69,5	1230 + 1241	700	90x80	87-89,5 / 77-79,5	1230 + 1242	712
95x70	92-94,5 / 67-69,5	1231 + 1241	710	95x80	92-94,5 / 77-79,5	1231 + 1242	722
100x70	97-99,5 / 67-69,5	1232 + 1241	720	100x80	97-99,5 / 77-79,5	1232 + 1242	732
105x70	102-104,5 / 67-69,5	1233 + 1241	730	105x80	102-104,5 / 77-79,5	1233 + 1242	742
110x70	107-109,5 / 67-69,5	1234 + 1241	741	110x80	107-109,5 / 77-79,5	1234 + 1242	753
115x70	112-114,5 / 67-69,5	1235 + 1241	751	115x80	112-114,5 / 77-79,5	1235 + 1242	763
120x70	117-119,5 / 67-69,5	1236 + 1241	760	120x80	117-119,5 / 77-79,5	1236 + 1242	772
125x70	122-124,5 / 67-69,5	1237 + 1241	767	125x80	122-124,5 / 77-79,5	1237 + 1242	779
130x70	127-129,5 / 67-69,5	1238 + 1241	776	130x80	127-129,5 / 77-79,5	1238 + 1242	788
135x70	132-134,5 / 67-69,5	1239 + 1241	784	135x80	132-134,5 / 77-79,5	1239 + 1242	796
140x70	137-139,5 / 67-69,5	1240 + 1241	790	140x80	137-139,5 / 77-79,5	1240 + 1242	802
145x70	142-144,5 / 67-69,5	1243 + 1241	802	145x80	142-144,5 / 77-79,5	1243 + 1242	814
150x70	147-149,5 / 67-69,5	1244 + 1241	813	150x80	147-149,5 / 77-79,5	1244 + 1242	825
155x70	152-154,5 / 67-69,5	1245 + 1241	826	155x80	152-154,5 / 77-79,5	1245 + 1242	838
160x70	157-159,5 / 67-69,5	1246 + 1241	838	160x80	157-159,5 / 77-79,5	1246 + 1242	850

Descripción	Referencias	Puntos
Perfil compensación +3 cm solo para lateral fijo	0218	35
Perfil compensación +6 cm solo para lateral fijo	0029	45



Laterales fijos a Medida TRIO (más información en página 291)

Descripción	Referencias	Puntos	Cajonado
Lateral fijo a medida hasta 40 cm	1342	206	+21
Lateral fijo a medida desde 40 hasta 80 cm	1303	286	+21
Lateral fijo a medida desde 80 hasta 120 cm	1309	356	+21

*Plazo de entrega 15 días

TRIO NEGRA 1 fijo + 2 correderas



Descripción	Rango	Apertura	Referencias	Puntos
Frontal 1F+2C TRIO NEGRA 100	96-101	49-51	1232N	500
Frontal 1F+2C TRIO NEGRA 105	101-106	53-55	1233N	510
Frontal 1F+2C TRIO NEGRA 110	106-111	56-58	1234N	521
Frontal 1F+2C TRIO NEGRA 115	111-116	59-61	1235N	531
Frontal 1F+2C TRIO NEGRA 120	116-121	63-65	1236N	540
Pletina embellecedora negra 195x3,8 cm			0007N	30
Opción gomas verticales negras			0014	15

TRIO NEGRA frontal + lateral fijo



Medidas	Rangos	Referencias	Puntos
100x70	97-99,5 / 67-69,5	1232N+1241N	730
105x70	102-104,5 / 67-69,5	1233N+1241N	740
110x70	107-109,5 / 67-69,5	1234N+1241N	751
115x70	112-114,5 / 67-69,5	1235N+1241N	761
120x70	117-119,5 / 67-69,5	1236N+1241N	770
100x80	97-99,5 / 77-79,5	1232N+1242N	742
105x80	102-104,5 / 77-79,5	1233N+1242N	752
110x80	107-109,5 / 77-79,5	1234N+1242N	763
115x80	112-114,5 / 77-79,5	1235N+1242N	773
120x80	117-119,5 / 77-79,5	1236N+1242N	782

*Las aperturas son las mismas que en los frontales.

Descripción	Referencias	Puntos
Perfil compensación +3 cm solo para lateral fijo	9016	35

Laterales fijos a medida TRIO NEGRA (más información en página 291)

Descripción	Referencias	Puntos	Cajonado
Lateral fijo a medida hasta 40 cm	1342N	206	+21
Lateral fijo a medida desde 40 hasta 80 cm	1303N	286	+21
Lateral fijo a medida desde 80 hasta 120 cm	1309N	356	+21

*Plazo de entrega 15 días

BYPASS 2 correderas



Descripción	Rango	Apertura	Referencias	Puntos
Frontal BYPASS 140	128 -138	55-65	1272	581
Frontal BYPASS 150	138 -148	60-70	1273	596
Frontal BYPASS 160	148 -158	65-75	1274	612



Rodamiento oculto 4 poleas

BYPASS frontal + lateral fijo

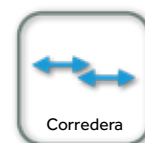

Laterales fijos BYPASS

Descripción	Rango	Ref.	Puntos
Lateral fijo BYPASS 70	66-69	1275	257
Lateral fijo BYPASS 80	76-79	1276	267

Combinaciones frontales BYPASS + lateral fijo

Medidas	Rangos	Referencias	Puntos	Medidas	Rangos	Referencias	Puntos
140x70	130-140/66-69	1272 + 1275	838	140x80	130-140/76-79	1272 + 1276	848
150x70	140-150/66-69	1273 + 1275	853	150x80	140-150/76-79	1273 + 1276	863
160x70	150-160/66-69	1274 + 1275	869	160x80	150-160/76-79	1274 + 1276	879

*Las aperturas son las mismas que en los frontales.



Laterales fijos a medida (más información en página 290)

Descripción	Referencias	Puntos	Cajonado
Lateral fijo a medida BYPASS hasta 40 cm	1346	218	+21
Lateral fijo a medida BYPASS desde 40 hasta 80 cm	1318	297	+21
Lateral fijo a medida BYPASS desde 80 hasta 120 cm	1319	367	+21

*Plazo de entrega 15 días

PUERTAS DE PASO CROMO



Descripción	Ref.	Puntos
Puerta de 75 cm + kit barra/guía 150 cm cromo	1750+1752	338
Puerta de 85 cm + kit barra/guía 170 cm cromo	1751+1753	357

PUERTAS A MEDIDA Y ESPECIALES	
TRANSP.	MATE
+45%	+60%

*Plazo de entrega 15 días

PUERTAS DE PASO NEGRO

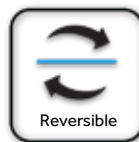

+SOLUCIONES

Descripción	Ref.	Puntos
Puerta de 75 cm + kit barra/guía 150 cm negro	1750+1754	338
Puerta de 85 cm + kit barra/guía 170 cm negro	1751+1755	357

PUERTAS A MEDIDA Y ESPECIALES	
TRANSP.	MATE
+45%	+60%

*Plazo de entrega 15 días

OPEN
pg.266 ● ●



OPEN 2
pg.268



GLASS PLEG.
pg.269



GME

FIJO SCREEN

pg.270 ● ● ● ● ● ● ● ●



BASIC

pg.274 ● ● ● ● ● ● ● ●



MAMPARAS DE BAÑERA

Open 1

Abatibles bañera

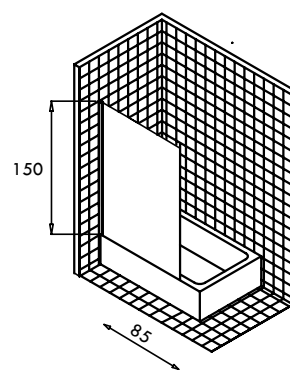
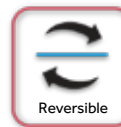

Open 1

Abatible de bañera 85x150

Descripción	Ref.	Puntos
Abatible 150x85 cm	0121	169

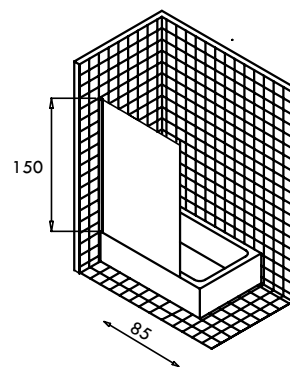

Open 1 Frost Plus

Abatible de bañera 85x150

Descripción	Ref.	Puntos
Abatible Frost Plus 150x85 cm	0123	175

Open 1 Negra

Abatible de bañera 85x150

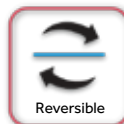

Descripción	Ref.	Puntos
Abatible 150x85 cm	0121N	169



Open 2

Fijo + abatible bañera



Open 2

Fijo + abatible 150x122

Descripción	Ref.	Puntos
Panel Open 2 transparente	0120+0121	257

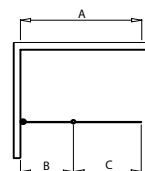
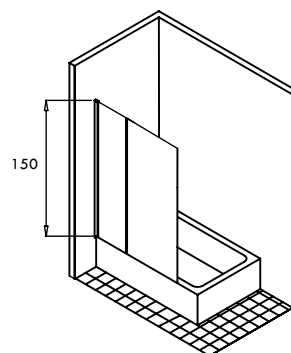

A	B	C
120	37	83

perfil aluminio cromo brillo
vidrio templado 6mm
elevación al girar



Open 2 Frost Plus

Fijo + abatible 150x122

Descripción	Ref.	Puntos
Panel Open 2 frost plus	0122+0123	271

Open 2 Negra

Fijo + abatible 150x122

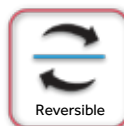

Descripción	Ref.	Puntos
Panel Open 2 negro transparente	0120N+0121N	257





Glass plegable

Glass plegable de bañera 94,5x150 cm (47+47)



Ref.	Puntos
1733	299

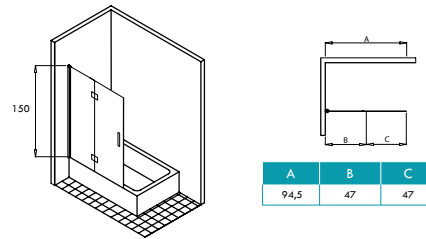

Screen

fijos de bañera 150x85

Screen Cromo



Descripción	Ref.	Puntos
CROMO 150x85 cm	0118	159

Incluye brazo orientable **recto/45°** ajustable 60-120 cm



Screen Cromo Frost



Descripción	Ref.	Puntos
CROMO Frost 150x85 cm	0119	194

Incluye brazo orientable **recto/45°** ajustable 60-120 cm

Screen Negra



Descripción	Ref.	Puntos
NEGRA 150x85 cm	0118N	199

Incluye brazo orientable **recto/45°** ajustable 60-120 cm

Screen Negra Frost



Descripción	Ref.	Puntos
NEGRA Frost 150x85 cm	SC85FN	253

Incluye brazo orientable **recto/45°** ajustable 60-120 cm

Screen Blanca



Descripción	Ref.	Puntos
BLANCA 150x85 cm	SC85B	218

Incluye brazo orientable **recto/45°** ajustable 60-120 cm

Screen Blanca Frost



Descripción	Ref.	Puntos
BLANCA Frost 150x85 cm	SC85FB	253

Incluye brazo orientable **recto/45°** ajustable 60-120 cm

Screen color

fijos de bañera 150x85

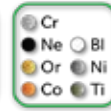
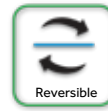

Screen Oro



Descripción	Ref.	Puntos
ORO 150x85 cm	SC85OR	265

Incluye brazo orientable **recto/45°** ajustable 60-120 cm

Screen Oro Frost



Descripción	Ref.	Puntos
ORO Frost 150x85 cm	SC85FOR	300

Incluye brazo orientable **recto/45°** ajustable 60-120 cm

Screen Níquel



Descripción	Ref.	Puntos
NÍQUEL 150x85 cm	SC85NK	265

Incluye brazo orientable **recto/45°** ajustable 60-120 cm

Screen Níquel Frost



Descripción	Ref.	Puntos
NÍQUEL Frost 150x85 cm	SC85FNK	300

Incluye brazo orientable **recto/45°** ajustable 60-120 cm

Screen color

fijos de bañera 150x85

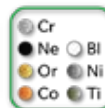

Screen Cobre



Descripción	Ref.	Puntos
COBRE 150x85 cm	SC85CB	265

Incluye brazo orientable **recto/45°** ajustable 60-120 cm

Screen Cobre Frost



Descripción	Ref.	Puntos
COBRE Frost 150x85 cm	SC85FCB	300

Incluye brazo orientable **recto/45°** ajustable 60-120 cm

Screen Titanio



Descripción	Ref.	Puntos
TITANIO 150x85 cm	SC85T	265

Incluye brazo orientable **recto/45°** ajustable 60-120 cm

Screen Titanio Frost



Descripción	Ref.	Puntos
TITANIO Frost 150x85 cm	SC85FT	300

Incluye brazo orientable **recto/45°** ajustable 60-120 cm

BASIC BAÑERA 1F+1C

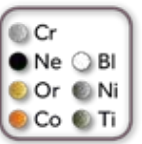
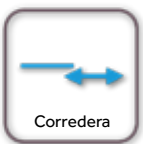

Rango	Apert.	TRANSPARENTE				FROST PLUS			
		CROM	NEGR	BLAN	Puntos	CROM	NEGR	BLAN	Puntos
140-145	56-61	5801	5801N	5801B	333	6801	6801N	6801B	349
145-150	61-66	5802	5802N	5802B	337	6802	6802N	6802B	356
150-155	61-66	5803	5803N	5803B	342	6803	6803N	6803B	360
155-160	66-71	5804	5804N	5804B	345	6804	6804N	6804B	366
160-165	61-66	5805	5805N	5805B	351	6805	6805N	6805B	369
165-170	66-71	5806	5806N	5806B	356	6806	6806N	6806B	375

Accesorios	CROMO	NEGRO	BLANCO	Puntos
Perfil de compensación +1,5 cm	5429	5477	5473	35
Pletina embellecedora 195x3,8 cm	0007	0007N	0007B	30



A MEDIDA Y ESPECIALES
Ver pag. 288

BASIC BAÑERA 1F+1C

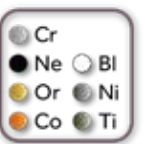
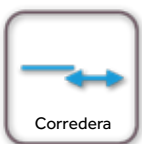

Rango	TRANSPARENTE				Puntos
	ORO	NÍQ	COBR	TITA	
140-145	5801OR	5801NK	5801CB	5801T	366
145-150	5802OR	5802NK	5802CB	5802T	370
150-155	5803OR	5803NK	5803CB	5803T	375
155-160	5804OR	5804NK	5804CB	5804T	378
160-165	5805OR	5805NK	5805CB	5805T	384
165-170	5806OR	5806NK	5806CB	5806T	389

FROST PLUS				
ORO	NÍQ	COBR	TITA	Puntos
6801OR	6801NK	6801CB	6801T	382
6802OR	6802NK	6802CB	6802T	389
6803OR	6803NK	6803CB	6803T	393
6804OR	6804NK	6804CB	6804T	399
6805OR	6805NK	6805CB	6805T	402
6806OR	6806NK	6806CB	6806T	408

Accesorios	ORO	NÍQUEL	COBRE	TITANIO	Puntos
Perfil de compensación +1,5 cm	5474	5475	5476	5478	45
Pletina embellecedora 195x3,8 cm	0007OR	0007NK	0007CB	0007T	40

BASIC BAÑERA + lateral fijo de 8 mm

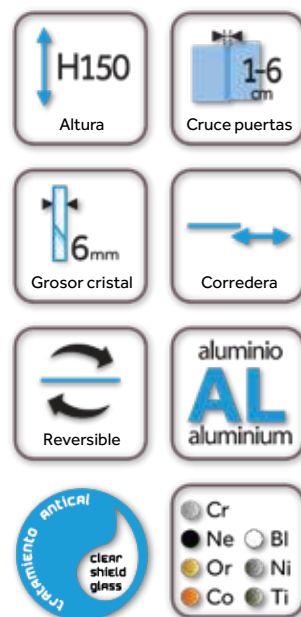

Laterales fijos bañera

Descripción	Rango
Lateral fijo BASIC 70x150	67-70
Lateral fijo BASIC 75x150	72-74

TRANSPARENTE	
Ref.	Puntos
5065CR	175
5066CR	195

FROST PLUS	
Ref.	Puntos
6065CR	180
6066CR	200

combinaciones BASIC BAÑERA + lateral fijo de 8 mm

Medida	Rangos	Apertura
145x70	140-145/67-70	56-61
150x70	145-150/67-70	61-66
155x70	150-155/67-70	61-66
160x70	155-160/67-70	66-71
165x70	160-165/67-70	61-66
170x70	165-170/67-70	66-71
Medida	Rangos	Apertura
145x75	140-145/72-74	56-61
150x75	145-150/72-74	61-66
155x75	150-155/72-74	61-66
160x75	155-160/72-74	66-71
165x75	160-165/72-74	61-66
170x75	165-170/72-74	66-71

TRANSPARENTE	
Referencias	Puntos
5801+5065CR	508
5802+5065CR	512
5803+5065CR	517
5804+5065CR	520
5805+5065CR	526
5806+5065CR	531
Referencias	Puntos
5801+5066CR	528
5802+5066CR	532
5803+5066CR	537
5804+5066CR	540
5805+5066CR	546
5806+5066CR	551

FROST PLUS	
Referencias	Puntos
6801+6065CR	529
6802+6065CR	536
6803+6065CR	540
6804+6065CR	546
6805+6065CR	549
6806+6065CR	555
Referencias	Puntos
6801+6066CR	549
6802+6066CR	556
6803+6066CR	560
6804+6066CR	566
6805+6066CR	569
6806+6066CR	575

*Opción perfil unión fijo-fijo cromo ref. 0182 +40 puntos (indicar mano).



Laterales fijos a medida

Descripción
medida hasta 40 cm
medida de 40 hasta 80 cm
medida de 80 hasta 120 cm

TRANSPARENTE	
Ref.	Puntos
1350	216
1334	296
1335	366

FROST PLUS	
Ref.	Puntos
1350+1312	338
1334+1313	418
1335+1315	488

Cajonado
+21
+21
+21

*Plazo de entrega 15 días

BASIC COLOR BAÑERA + lateral fijo de 8 mm



Laterales fijos bañera

Descripción	Rango
Lateral fijo BASIC 70x150	67-70
Lateral fijo BASIC 75x150	72-74

TRANSPARENTE		Puntos
● NEGRO	● BLANCO	
5065N	5065B	235
5066N	5066B	255

FROST PLUS		Puntos
● NEGRO	● BLANCO	
6065N	6065B	240
6066N	6066B	260

Rango (frontal/lat.fijo)	TRANSPARENTE		Puntos
	● NEGRO	● BLANCO	
140-145/67-70	5801N+5065N	5801B+5065B	568
145-150/67-70	5802N+5065N	5802B+5065B	572
150-155/67-70	5803N+5065N	5803B+5065B	577
155-160/67-70	5804N+5065N	5804B+5065B	580
160-165/67-70	5805N+5065N	5805B+5065B	586
165-170/67-70	5806N+5065N	5806B+5065B	591
Rango (frontal/lat.fijo)	● NEGRO	● BLANCO	Puntos
140-145/72-74	5801N+5066N	5801B+5066B	588
145-150/72-74	5802N+5066N	5802B+5066B	592
150-155/72-74	5803N+5066N	5803B+5066B	597
155-160/72-74	5804N+5066N	5804B+5066B	600
160-165/72-74	5805N+5066N	5805B+5066B	606
165-170/72-74	5806N+5066N	5806B+5066B	611

Rango (frontal/lat.fijo)	FROST PLUS		Puntos
	● NEGRO	● BLANCO	
140-145/67-70	6801N+6065N	6801B+6065B	589
145-150/67-70	6802N+6065N	6802B+6065B	596
150-155/67-70	6803N+6065N	6803B+6065B	600
155-160/67-70	6804N+6065N	6804B+6065B	606
160-165/67-70	6805N+6065N	6805B+6065B	609
165-170/67-70	6806N+6065N	6806B+6065B	615
Rango (frontal/lat.fijo)	● NEGRO	● BLANCO	Puntos
140-145/72-74	6801N+6066N	6801B+6066B	609
145-150/72-74	6802N+6066N	6802B+6066B	616
150-155/72-74	6803N+6066N	6803B+6066B	620
155-160/72-74	6804N+6066N	6804B+6066B	626
160-165/72-74	6805N+6066N	6805B+6066B	629
165-170/72-74	6806N+6066N	6806B+6066B	635

*Opción perfil unión fijo-fijo negro ref. 0991 +40 puntos (indicar mano).

*Opción perfil unión fijo-fijo blanco ref. 0182B +40 puntos (indicar mano).



Lat. fijos a medida

Descripción
Hasta 40 cm
De 40 hasta 80 cm
De 80 hasta 120 cm

TRANSPARENTE		
● NEGRO	● BLANCO	Puntos
1350N	1350B	216
1334N	1334B	296
1335N	1335B	366

FROST PLUS		
● NEGRO	● BLANCO	Puntos
1350N+1312	1350B+1312	338
1334N+1313	1334B+1313	418
1335N+1315	1335B+1315	488

*Plazo de entrega 15 días

BASIC COLOR BAÑERA + lateral fijo de 8 mm



Laterales fijos bañera

Descripción	Rango
Lateral fijo BASIC 70x150	67-70
Lateral fijo BASIC 75x150	72-74

TRANSPARENTE		Puntos
ORO	NÍQUEL	
5065OR	5065NK	270
5066OR	5066NK	290

FROST PLUS		Puntos
ORO	NÍQUEL	
6065OR	6065NK	275
6066OR	6066NK	295

Rango (frontal/lat.fijo)	TRANSPARENTE		Puntos	FROST PLUS		Puntos
	ORO	NÍQUEL		ORO	NÍQUEL	
140-145/67-70	5801OR+5065OR	5801NK+5065NK	636	6801OR+6065OR	6801NK+6065NK	657
145-150/67-70	5802OR+5065OR	5802NK+5065NK	640	6802OR+6065OR	6802NK+6065NK	664
150-155/67-70	5803OR+5065OR	5803NK+5065NK	645	6803OR+6065OR	6803NK+6065NK	668
155-160/67-70	5804OR+5065OR	5804NK+5065NK	648	6804OR+6065OR	6804NK+6065NK	674
160-165/67-70	5805OR+5065OR	5805NK+5065NK	654	6805OR+6065OR	6805NK+6065NK	677
165-170/67-70	5806OR+5065OR	5806NK+5065NK	659	6806OR+6065OR	6806NK+6065NK	683
Rango (frontal/lat.fijo)	ORO	NÍQUEL	Puntos	ORO	NÍQUEL	Puntos
140-145/72-74	5801OR+5066OR	5801NK+5066NK	656	6801OR+6066OR	6801NK+6066NK	677
145-150/72-74	5802OR+5066OR	5802NK+5066NK	660	6802OR+6066OR	6802NK+6066NK	684
150-155/72-74	5803OR+5066OR	5803NK+5066NK	665	6803OR+6066OR	6803NK+6066NK	688
155-160/72-74	5804OR+5066OR	5804NK+5066NK	668	6804OR+6066OR	6804NK+6066NK	694
160-165/72-74	5805OR+5066OR	5805NK+5066NK	674	6805OR+6066OR	6805NK+6066NK	697
165-170/72-74	5806OR+5066OR	5806NK+5066NK	679	6806OR+6066OR	6806NK+6066NK	703

*Opción perfil unión fijo-fijo oro ref. 0182OR +50 puntos (indicar mano).

*Opción perfil unión fijo-fijo níquel ref. 0182NK +50 puntos (indicar mano).



Lat. fijos a medida

Descripción
Hasta 40 cm
De 40 hasta 80 cm
De 80 hasta 120 cm

TRANSPARENTE		Puntos
ORO	NÍQUEL	
1350OR	1350NK	251
1334OR	1334NK	331
1335OR	1335NK	401

FROST PLUS		Puntos
ORO	NÍQUEL	
1350OR+1312	1350NK+1312	373
1334OR+1313	1334NK+1313	453
1335OR+1315	1335NK+1315	523

*Plazo de entrega 15 días

BASIC COLOR BAÑERA + lateral fijo de 8 mm



Laterales fijos bañera

Descripción	Rango
Lateral fijo BASIC 70x150	67-70
Lateral fijo BASIC 75x150	72-74

TRANSPARENTE		Puntos
COBRE	TITANIO	
5065CB	5065T	270
5066CB	5066T	290

FROST PLUS		Puntos
COBRE	TITANIO	
6065CB	6065T	275
6066CB	6066T	295

Rango (frontal/lat.fijo)	TRANSPARENTE		Puntos
	COBRE	TITANIO	
140-145/67-70	5801CB+5065CB	5801T+5065T	636
145-150/67-70	5802CB+5065CB	5802T+5065T	640
150-155/67-70	5803CB+5065CB	5803T+5065T	645
155-160/67-70	5804CB+5065CB	5804T+5065T	648
160-165/67-70	5805CB+5065CB	5805T+5065T	654
165-170/67-70	5806CB+5065CB	5806T+5065T	659
Rango (frontal/lat.fijo)	COBRE	TITANIO	Puntos
140-145/72-74	5801CB+5066CB	5801T+5066T	656
145-150/72-74	5802CB+5066CB	5802T+5066T	660
150-155/72-74	5803CB+5066CB	5803T+5066T	665
155-160/72-74	5804CB+5066CB	5804T+5066T	668
160-165/72-74	5805CB+5066CB	5805T+5066T	674
165-170/72-74	5806CB+5066CB	5806T+5066T	679

Rango (frontal/lat.fijo)	FROST PLUS		Puntos
	COBRE	TITANIO	
140-145/67-70	6801CB+6065CB	6801T+6065T	657
145-150/67-70	6802CB+6065CB	6802T+6065T	664
150-155/67-70	6803CB+6065CB	6803T+6065T	668
155-160/67-70	6804CB+6065CB	6804T+6065T	674
160-165/67-70	6805CB+6065CB	6805T+6065T	677
165-170/67-70	6806CB+6065CB	6806T+6065T	683
Rango (frontal/lat.fijo)	COBRE	TITANIO	Puntos
140-145/72-74	6801CB+6066CB	6801T+6066T	677
145-150/72-74	6802CB+6066CB	6802T+6066T	684
150-155/72-74	6803CB+6066CB	6803T+6066T	688
155-160/72-74	6804CB+6066CB	6804T+6066T	694
160-165/72-74	6805CB+6066CB	6805T+6066T	697
165-170/72-74	6806CB+6066CB	6806T+6066T	703

*Opción perfil unión fijo-fijo cobre ref. 0182CB +50 puntos (indicar mano).

*Opción perfil unión fijo-fijo titanio ref. 0182T +50 puntos (indicar mano).



Lat. fijos a medida

Descripción
Hasta 40 cm
De 40 hasta 80 cm
De 80 hasta 120 cm

TRANSPARENTE		
COBRE	TITANIO	Puntos
1350CB	1350T	251
1334CB	1334T	331
1335CB	1335T	401

FROST PLUS		
COBRE	TITANIO	Puntos
1350CB+1312	1350T+1312	373
1334CB+1313	1334T+1313	453
1335CB+1315	1335T+1315	523

*Plazo de entrega 15 días

BASIC BAÑERA 2F+ 2C

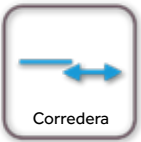

Rango	Apert.	TRANSPARENTE				FROST PLUS			
		● CROM	● NEGR	● BLAN	Puntos	● CROM	● NEGR	● BLAN	Puntos
152-162	64-74	5810	5810N	5810B	413	6810	6810N	6810B	433
162-172	66-76	5811	5811N	5811B	423	6811	6811N	6811B	443
172-182	72-82	5812	5812N	5812B	431	6812	6812N	6812B	451

Accesorios	CROMO	NEGRO	BLANCO	Puntos
Perfil de compensación +1,5 cm	5429	5477	5473	35
Pletina embellecedora 195x3,8 cm	0007	0007N	0007B	30
Opción perfil unión fijo-fijo (indicar mano)	0182	0991	0182B	40



A MEDIDA
Y ESPECIALES
Ver pag. 288

BASIC BAÑERA 2F+ 2C



Rango	TRANSPARENTE				Puntos	FROST PLUS				Puntos
	ORO	NÍQ	COBR	TITA		ORO	NÍQ	COBR	TITA	
152-162	5810OR	5810NK	5810CB	5810T	472	6810OR	6810NK	6810CB	6810T	492
162-172	5811OR	5811NK	5811CB	5811T	482	6811OR	6811NK	6811CB	6811T	502
172-182	5812OR	5812NK	5812CB	5812T	490	6812OR	6812NK	6812CB	6812T	510

Accesorios	ORO	NÍQUEL	COBRE	TITANIO	Puntos
Perfil de compensación +1,5 cm	5474	5475	5476	5478	45
Pletina embellecedora 195x3,8 cm	0007OR	0007NK	0007CB	0007T	40
Opción perfil unión fijo-fijo (indicar mano)	0182OR	0182NK	0182CB	0182T	50

BASIC BAÑERA + lateral fijo de 8 mm



H150 Altura	1-6 cm Cruce puertas
6mm Grosor cristal	Corredera
Reversible	aluminio AL aluminium
Tratamiento antical clear shield glass	Cr, Ne, Or, Co, BI, Ni, Ti

AL REALIZAR EL PEDIDO SE DEBE INDICAR LA MANO DÓNDE VA INSTALADO EL LATERAL FIJO

Laterales fijos bañera

Descripción	Rango
Lateral fijo BASIC 70x150	67-70
Lateral fijo BASIC 75x150	72-74

TRANSPARENTE	
Ref.	Puntos
5065CR	175
5066CR	195

FROST PLUS	
Ref.	Puntos
6065CR	180
6066CR	200

combinaciones frontales BASIC 2F+2C + lateral fijo de 8 mm

Medida	Rangos	Apertura
160x70	152-162/67-69	64-74
170x70	162-172/67-69	66-76
180x70	172-182/67-69	72-82
Medida	Rangos	Apertura
160x75	152-162/72-74	64-74
170x75	162-172/72-74	66-76
180x75	172-182/72-74	72-82

TRANSPARENTE	
Referencias	Puntos
5810+5065CR+0182	628
5811+5065CR+0182	638
5812+5065CR+0182	646
Referencias	Puntos
5810+5066CR+0182	648
5811+5066CR+0182	658
5812+5066CR+0182	666

FROST PLUS	
Referencias	Puntos
6810+6065CR+0182	653
6811+6065CR+0182	663
6812+6065CR+0182	671
Referencias	Puntos
6810+6066CR+0182	673
6811+6066CR+0182	683
6812+6066CR+0182	691

*Al realizar el pedido se debe indicar el lado dónde va instalado el lateral fijo



Laterales fijos a medida

Descripción
medida hasta 40 cm
medida de 40 hasta 80 cm
medida de 80 hasta 120 cm

TRANSPARENTE	
Ref.	Puntos
1350+0182	256
1334+0182	336
1335+0182	406

FROST PLUS	
Ref.	Puntos
1350+0182+1312	378
1334+0182+1313	458
1335+0182+1315	528

Cajonado
+21
+21
+21

Indicar mano dónde va el lateral fijo. Plazo de entrega 15 días.

BASIC COLOR BAÑERA + lateral fijo de 8 mm

FRONTAL PERFILERÍA NEGRA



FRONTAL PERFILERÍA BLANCA



Laterales fijos bañera

Descripción	Rango	TRANSPARENTE			FROST PLUS		
		● NEGRO	● BLANCO	Puntos	● NEGRO	● BLANCO	Puntos
Lateral fijo BASIC 70x150	67-70	5065N	5065B	235	6065N	6065B	240
Lateral fijo BASIC 75x150	72-74	5066N	5066B	255	6066N	6066B	260

Rangos	TRANSPARENTE			FROST PLUS		
	● NEGRO	● BLANCO	Puntos	● NEGRO	● BLANCO	Puntos
152-162/67-69	5810N+5065N+0991	5810B+5065B+0182B	688	6810N+6065N+0991	6810B+6065B+0182B	713
162-172/67-69	5811N+5065N+0991	5811B+5065B+0182B	698	6811N+6065N+0991	6811B+6065B+0182B	723
172-182/67-69	5812N+5065N+0991	5812B+5065B+0182B	706	6812N+6065N+0991	6812B+6065B+0182B	731
Rangos	● NEGRO	● BLANCO	Puntos	● NEGRO	● BLANCO	Puntos
152-162/72-74	5810N+5066N+0991	5810B+5066B+0182B	708	6810N+6066N+0991	6810B+6066B+0182B	733
162-172/72-74	5811N+5066N+0991	5811B+5066B+0182B	718	6811N+6066N+0991	6811B+6066B+0182B	743
172-182/72-74	5812N+5066N+0991	5812B+5066B+0182B	726	6812N+6066N+0991	6812B+6066B+0182B	751

*Al realizar el pedido se debe indicar el lado dónde va instalado el lateral fijo

Laterales a medida

Descripción	TRANSPARENTE			FROST PLUS		
	● NEGRO	● BLANCO	P	● NEGRO	● BLANCO	P
medida hasta 40 cm	1350N+0991	1350B+0182B	256	1350N+0991+1312	1350B+0182B+1312	378
medida de 40 hasta 80 cm	1334N+0991	1334B+0182B	336	1334N+0991+1313	1334B+0182B+1313	458
medida de 80 hasta 120 cm	1335N+0991	1335B+0182B	406	1335N+0991+1315	1335B+0182B+1315	528

Indicar mano dónde va el lateral fijo. Plazo de entrega 15 días. Cajonado +21 puntos.

BASIC COLOR BAÑERA + lateral fijo de 8 mm



Laterales fijos bañera

Descripción	Rango
Lateral fijo BASIC 70x150	67-70
Lateral fijo BASIC 75x150	72-74

TRANSPARENTE		Puntos
ORO	NÍQUEL	
5065OR	5065NK	270
5066OR	5066NK	290

FROST PLUS		Puntos
ORO	NÍQUEL	
6065OR	6065NK	275
6066OR	6066NK	295

Rangos	TRANSPARENTE		Puntos
	ORO	NÍQUEL	
140-145/67-70	5810OR+5065OR+0182OR	5810NK+5065NK+0182NK	792
145-150/67-70	5811OR+5065OR+0182OR	5811NK+5065NK+0182NK	802
150-155/67-70	5812OR+5065OR+0182OR	5812NK+5065NK+0182NK	810
Rangos	ORO	NÍQUEL	Puntos
140-145/72-74	5810OR+5066OR+0182OR	5810NK+5066NK+0182NK	812
145-150/72-74	5811OR+5066OR+0182OR	5811NK+5066NK+0182NK	822
150-155/72-74	5812OR+5066OR+0182OR	5812NK+5066NK+0182NK	830

Rangos	FROST PLUS		Puntos
	ORO	NÍQUEL	
140-145/67-70	6810OR+6065OR+0182OR	6810NK+6065NK+0182NK	817
145-150/67-70	6811OR+6065OR+0182OR	6811NK+6065NK+0182NK	827
150-155/67-70	6812OR+6065OR+0182OR	6812NK+6065NK+0182NK	835
Rangos	ORO	NÍQUEL	Puntos
140-145/72-74	6810OR+6066OR+0182OR	6810NK+6066NK+0182NK	837
145-150/72-74	6811OR+6066OR+0182OR	6811NK+6066NK+0182NK	847
150-155/72-74	6812OR+6066OR+0182OR	6812NK+6066NK+0182NK	855

*Al realizar el pedido se debe indicar el lado dónde va instalado el lateral fijo

Lat. fijos a medida

Descripción	TRANSPARENTE		Puntos
	ORO	NÍQUEL	
Hasta 40 cm	1350OR+0182OR	1350NK+0182NK	301
De 40 hasta 80 cm	1334OR+0182OR	1334NK+0182NK	381
De 80 hasta 120 cm	1335OR+0182OR	1335NK+0182NK	451

Descripción	FROST PLUS		Puntos
	ORO	NÍQUEL	
Hasta 40 cm	1350OR+0182OR+1312	1350NK+0182NK+1312	423
De 40 hasta 80 cm	1334OR+0182OR+1313	1334NK+0182NK+1313	503
De 80 hasta 120 cm	1335OR+0182OR+1315	1335NK+0182NK+1315	573

Indicar mano dónde va el lateral fijo. Plazo de entrega 15 días. Cajonado +21 puntos.

BASIC COLOR BAÑERA + lateral fijo de 8 mm



Laterales fijos bañera

Descripción	Rango
Lateral fijo BASIC 70x150	67-70
Lateral fijo BASIC 75x150	72-74

TRANSPARENTE		Puntos
COBRE	TITANIO	
5065CB	5065T	270
5066CB	5066T	290

FROST PLUS		Puntos
COBRE	TITANIO	
6065CB	6065T	275
6066CB	6066T	295

Rangos	TRANSPARENTE		Puntos
	COBRE	TITANIO	
140-145/67-70	5810CB+5065CB+0182CB	5810T+5065T+0182T	792
145-150/67-70	5811CB+5065CB+0182CB	5811T+5065T+0182T	802
150-155/67-70	5812CB+5065CB+0182CB	5812T+5065T+0182T	810
Rangos	COBRE	TITANIO	Puntos
140-145/72-74	5810CB+5066CB+0182CB	5810T+5066T+0182T	812
145-150/72-74	5811CB+5066CB+0182CB	5811T+5066T+0182T	822
150-155/72-74	5812CB+5066CB+0182CB	5812T+5066T+0182T	830

Rangos	FROST PLUS		Puntos
	COBRE	TITANIO	
140-145/67-70	6810CB+6065CB+0182CB	6810T+6065T+0182T	817
145-150/67-70	6811CB+6065CB+0182CB	6811T+6065T+0182T	827
150-155/67-70	6812CB+6065CB+0182CB	6812T+6065T+0182T	835
Rangos	COBRE	TITANIO	Puntos
140-145/72-74	6810CB+6066CB+0182CB	6810T+6066T+0182T	837
145-150/72-74	6811CB+6066CB+0182CB	6811T+6066T+0182T	847
150-155/72-74	6812CB+6066CB+0182CB	6812T+6066T+0182T	855

*Al realizar el pedido se debe indicar el lado dónde va instalado el lateral fijo

Lat. fijos a medida

Descripción	TRANSPARENTE		Puntos
	COBRE	TITANIO	
Hasta 40 cm	1350CB+0182CB	1350T+0182T	301
De 40 hasta 80 cm	1334CB+0182CB	1334T+0182T	381
De 80 hasta 120 cm	1335CB+0182CB	1335T+0182T	451

Descripción	FROST PLUS		Puntos
	COBRE	TITANIO	
Hasta 40 cm	1350CB+0182CB+1312	1350T+0182T+1312	423
De 40 hasta 80 cm	1334CB+0182CB+1313	1334T+0182T+1313	503
De 80 hasta 120 cm	1335CB+0182CB+1315	1335T+0182T+1315	573

Indicar mano dónde va el lateral fijo. Plazo de entrega 15 días. Cajonado +21 puntos.

BASIC BAÑERA FREE ANGULAR



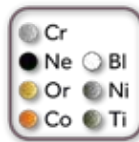
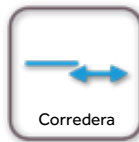

PASO 1: Seleccionar medida/color de la PERFILERÍA ANGULAR

PASO 2: Seleccionar medida/decorado de los CRISTALES

PASO 1: PERFILERÍA

Descripción	CROMO	NEGRO	BLANCO	Puntos
	Ref.	Ref.	Ref.	
Accesorios hasta 120x90 cm	5423+5447	5490+5447N	5580+5447B	260
Accesorios hasta 140x100 cm	5424+5447	5491+5447N	5581+5447B	270

Descripción	ORO	NÍQUEL	COBRE	TITANIO	Puntos
	Ref.	Ref.	Ref.	Ref.	
Accesorios hasta 120x90 cm	5448+5447OR	5463+5447NK	5590+5447CB	5563+5447T	345
Accesorios hasta 140x100 cm	5449+5447OR	5464+5447NK	5591+5447CB	5564+5447T	355

PASO 2: CRISTALES

Rangos (frontal / lado free)	TRANSPARENTE		FROST PLUS	
	Referencias	Puntos	Referencias	Puntos
140-145 / 65-100	5050	149	6050	165
145-150 / 65-100	5051	153	6051	172
150-155 / 65-100	5052	158	6052	176
155-160 / 65-100	5053	161	6053	182
160-165 / 65-100	5054	167	6054	185
165-170 / 65-100	5055	172	6055	191

Descripción	Referencias	Puntos
Perfil de compensación +1,5 cm cromo	5429	35
Perfil de compensación +1,5 cm negro	5477	35
Perfil de compensación +1,5 cm blanco	5473	35
Perfil de compensación +1,5 cm oro	5474	45
Perfil de compensación +1,5 cm níquel	5475	45
Perfil de compensación +1,5 cm cobre	5476	45
Perfil de compensación +1,5 cm titanio	5478	45



Mamparas a medida y cristales especiales	TRANSPARENTE	FROST PLUS PARSOL / MATE	CAJONADO
Altura hasta 195 cm	+45%	+60%	+21

*Plazo de entrega 15 días (más información en pág. 288)

MAMPARAS CORREDERAS A MEDIDA Y ESPECIALES

Futura Temple Basic Twenty

MAMPARAS A MEDIDAS TRANSPARENTES

- Para el cálculo del punto se incrementará un 45% al punto de la referencia que cubra ese rango o la inmediatamente superior.
- Indicar Modelo / Referencia / Medida.
- No se aceptan medidas de ancho superiores a la mayor de la tabla, excepto Basic hasta 220 cm de alto.

Ref. 0868

+45%

ALTURA
195 cm

**SOLO MODELO
BASIC CROMO**

Ref. 0871

+75%

ALTURA
196 a 220 cm

MAMPARAS A MEDIDA ACABADOS ESPECIALES

Acabado **FROST PLUS ÁCIDO, PARSOL, CARGLASS / MATE**

- Para el cálculo del punto se incrementará un 60% al punto de la referencia que cubra ese rango o la inmediatamente superior.
- Es necesario indicar la posición de la puerta y el fijo.
- Indicar Modelo / Referencia / Medida.
- No se aceptan medidas de ancho superiores a la mayor de la tabla, excepto Basic hasta 220 cm de alto.

Ref. 0870

+60%

ALTURA
195 cm

**SOLO MODELO
BASIC CROMO**

Ref. 0872

+90%

ALTURA
196 a 220 cm

ACABADOS ESPECIALES:



FROST PLUS



PARSOL BRONCE



PARSOL FUMÉ



MATE

PLAZO MEDIO DE ENTREGA 15 DÍAS (No se aceptarán devoluciones ni anulaciones de cristales a medida)

MAMPARAS ABATIBLES A MEDIDA

Glass Open Glass Plegable

PANELES FIJOS

MODELO
PANEL FIJO OPEN 6 mm
PANEL FIJO OPEN NEGRO 6 mm
PANEL FIJO GLASS 8 mm CROMO
PANEL FIJO GLASS 8 mm NEGRO
PANEL FIJO GLASS 8 mm BLANCO
PANEL FIJO GLASS 8 mm ORO
PANEL FIJO GLASS 8 mm COBRE
PANEL FIJO GLASS 8 mm NÍQUEL
PANEL FIJO GLASS 8 mm TITANIO

Ancho < 40 cm	
Ref.	Punto
1345	207
1345N	207
1339	385
1339N	385
1339BL	385
1339OR	448
1339CB	448
1339NK	448
1339T	448

Ancho > 40 y < 80 cm	
Ref.	Punto
1316	282
1316N	282
1336	435
1336N	435
1336BL	435
1336OR	498
1336CB	498
1336NK	498
1336T	498

Ancho > 80 y < 120 cm	
Ref.	Punto
1317	352
1317N	352
1337	550
1337N	550
1337BL	550
1337OR	613
1337CB	613
1337NK	613
1337T	613

Incluye perfiles y herrajes.

GLASS PLEGABLE

MODELO	Ancho < 80 cm	
	Ref.	Punto
PUERTA GLASS PLEGABLE 6 mm	1338	150

PUERTA GLASS CON BISAGRA A PARED

ACABADO	Ancho < 80 cm	
	Ref.	Punto
PUERTA GLASS 6 mm CROMO	1338CR	337
PUERTA GLASS 6 mm NEGRO	1338N	337
PUERTA GLASS 6 mm BLANCO	1338BL	337
PUERTA GLASS 6 mm ORO	1338OR	391
PUERTA GLASS 6 mm COBRE	1338CB	391
PUERTA GLASS 6 mm NÍQUEL	1338NK	391
PUERTA GLASS 6 mm TITANIO	1338T	391

Incluye puerta a medida + herrajes instalación bisagra a pared

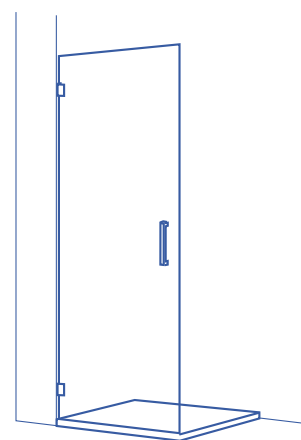

PUERTA GLASS CON BISAGRA A FIJO

ACABADO	Ancho < 80 cm	
	Ref.	Punto
PUERTA GLASS 6 mm CROMO	1385CR	332
PUERTA GLASS 6 mm NEGRO	1385N	332
PUERTA GLASS 6 mm BLANCO	1385BL	332
PUERTA GLASS 6 mm ORO	1385OR	395
PUERTA GLASS 6 mm COBRE	1385CB	395
PUERTA GLASS 6 mm NÍQUEL	1385NK	395
PUERTA GLASS 6 mm TITANIO	1385T	395

Incluye puerta a medida + herrajes instalación a cristal fijo

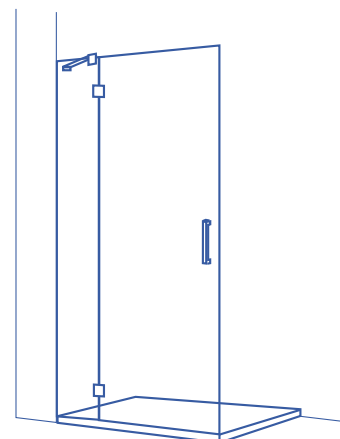

A MEDIDA

PLAZO MEDIO DE ENTREGA 15 DÍAS (No se aceptarán devoluciones ni anulaciones de cristales a medida)

LATERALES FIJOS A MEDIDA

MODELO	Ancho <40 cm		Ancho >40 y <80 cm		Ancho >80 y <120 cm	
	Ref.	Punto	Ref.	Punto	Ref.	Punto
Lateral Fijo 8 mm VETRUM	1340	305	1300	390	1306	460
Lateral Fijo 8 mm MOVING	1341	305	1301	390	1307	460
Lateral Fijo 8 mm TEMPLE	1349	226	1302	306	1308	376
Lateral Fijo 6 mm BYPASS	1346	218	1318	297	1319	367
Lateral Fijo 8 mm FUTURA	1347	229	1330	309	1331	379
Lateral Fijo 8 mm ROTARY	1348	226	1332	306	1333	376
Lateral fijo 8 mm VITRO	1351	227	1352	305	1353	375
*Fijo STD 8 mm AKTUAL / PRESTIGE / AKORD/OPEN/GLASS/GLASS PLEGABLE	1343	175	1304	250	1310	320
*Fijo STD NEGRO 8 mm	1343N	175	1304N	250	1310N	320

*No incluye brazo

Incremento acabado FROST PLUS	1312	+122	1313	+122	1315	+122
-------------------------------	------	------	------	------	------	------

*Indicar la posición del lateral

Incremento acabado PARSOL	Ref. 0870SC - Puntos Laterales fijos a medida +35%
---------------------------	---

LATERAL FIJO ALTURA ESPECIAL BASIC 195 A 220 (SOLO CROMO)

MODELO	Ref.	Punto	Ref.	Punto	Ref.	Punto
Lateral Fijo 8 mm BASIC 195 hasta 220 cm	1350H2	256	1334H2	336	1335H2	406

CAJONADO

Ref.: 0862 | Descripción: Corte escuadra/Cajonado
Puntos: 21

*Excepto Vetrum, Kenna, Prestigetitan, Aktual, Glass plegable y Bypass.

(Medida total incluido el perfil)

En caso de llevar cajonado, indique ubicación

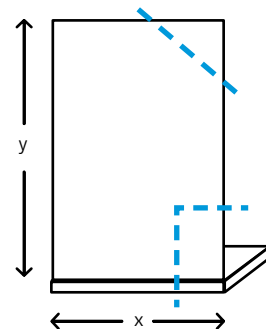
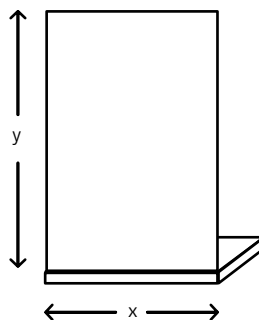

PLAZO MEDIO DE ENTREGA 15 DÍAS (No se aceptarán devoluciones ni anulaciones de cristales a medida)

LATERALES FIJOS A MEDIDA

BASIC	CROMO	NEGRO	BLANCO	Puntos
Ancho <40 cm	1350	1350N	1350B	216
Ancho >40 y <80 cm	1334	1334N	1334B	296
Ancho >80 y <120 cm	1335	1335N	1335B	366

BASIC	ORO	COBRE	NÍQUEL	TITANIO	Puntos
Ancho <40 cm	1350OR	1350CB	1350NK	1350T	251
Ancho >40 y <80 cm	1334OR	1334CB	1334NK	1334T	331
Ancho >80 y <120 cm	1335OR	1335CB	1335NK	1335T	401

GLASS/OPEN	CROMO	NEGRO	BLANCO	Puntos
Ancho <40 cm	1345	1345N	1345B	207
Ancho >40 y <80 cm	1316	1316N	1316B	282
Ancho >80 y <120 cm	1317	1317N	1317B	352

GLASS/OPEN	ORO	COBRE	NÍQUEL	TITANIO	Puntos
Ancho <40 cm	1345OR	1345CB	1345NK	1345T	217
Ancho >40 y <80 cm	1316OR	1316CB	1316NK	1316T	292
Ancho >80 y <120 cm	1317OR	1317CB	1317NK	1317T	362

*No incluye brazo

GLASS PLEGABLE	CROMO	NEGRO	Puntos
Ancho <40 cm	1380	1380N	207
Ancho >40 y <80 cm	1381	1381N	282
Ancho >80 y <120 cm	1382	1382N	352

*No incluye brazo

TRIO	CROMO	NEGRO	Puntos
Ancho <40 cm	1342	1342N	206
Ancho >40 y <80 cm	1303	1303N	286
Ancho >80 y <120 cm	1309	1309N	356

TWENTY	CROMO	Puntos	NEGRO	Puntos
Ancho <40 cm	1375	212	1375N	217
Ancho >40 y <80 cm	1376	291	1376N	296
Ancho >80 y <120 cm	1377	361	1377N	366

TWENTY	ORO	COBRE	Puntos
Ancho <40 cm	1375OR	1375CB	227
Ancho >40 y <80 cm	1376OR	1376CB	306
Ancho >80 y <120 cm	1377OR	1377CB	376

KENNA	CROMO	Puntos	NEGRO	Puntos	ORO	Puntos
Ancho <40 cm	1365	257	1365N	262	1365OR	280
Ancho >40 y <80 cm	1366	342	1366N	347	1366OR	365
Ancho >80 y <120 cm	1367	412	1367N	417	1367OR	435

FIJOS SCREEN A MEDIDA

(PLAZO ENTREGA 15 DÍAS)

Descripción	CROMO	NEGRO	BLANCO	Puntos
Ancho < 80 cm Altura hasta 195 cm	1305	1305N	1305B	333
Ancho de 80 a 120 cm Altura hasta 195 cm	1311	1311N	1311B	407

Descripción	ORO	COBRE	NÍQUEL	TITANIO	Puntos
Ancho < 80 cm Altura hasta 195 cm	1305OR	1305CB	1305NK	1305T	355
Ancho de 80 a 120 cm Altura hasta 195 cm	1311OR	1311CB	1311NK	1311T	429

Estos precios incluyen todos los componentes (herrajes y brazo) para su montaje.

ACABADO FROST PLUS

Descripción	Ref.	P	Descripción	Ref.	P
Incremento FROST PLUS ancho <80 cm	1313	122	Incremento FROST PLUS ancho 80-120 cm	1315	122

ALTURA XXL SOLO CROMO

Descripción	Ref.	Puntos
Ancho < 80 cm Altura de 195 hasta 220 cm	1363	399
Ancho de 80 a 120 cm Altura de 195 hasta 220 cm	1364	499

*Incluye brazo

CAJONADO

Descripción	Ref.	Puntos
Corte Escuadra/Cajonado	0862	21

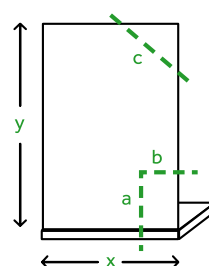

En caso de llevar cajonado, indique medidas

ACABADOS PARSOL EN SCREEN/LATERALES FIJOS A MEDIDA 8 mm
Ref. 0870SC - Puntos Screen a medida +35%



FROST PLUS



PARSOL BRONCE



PARSOL FUMÉ



MATE

PLAZO MEDIO DE ENTREGA 15 DÍAS (No se aceptarán devoluciones ni anulaciones de cristales a medida)

SCREEN MÓVIL BISAGRAS 180° A MEDIDA

(PLAZO ENTREGA 15 DÍAS)

Descripción	CROMO	NEGRO	BLANCO	Puntos	
Ancho <40 cm Altura hasta 195 cm	1355	1355N	1355B	206	
De 40 hasta 80 cm Altura hasta 195 cm	1356	1356N	1356B	271	
Descripción	ORO	COBRE	NÍQUEL	TITANIO	Puntos
Ancho < 80 cm Altura hasta 195 cm	1355OR	1355CB	1355NK	1355T	219
Ancho < 80 cm Altura hasta 195 cm	1356OR	1356CB	1356NK	1356T	284

Estos precios incluyen todos los componentes (herrajes y bisagras) para su montaje.

ACABADO FROST PLUS

Descripción	Ref.	Puntos
Incremento FROST PLUS ancho <80 cm	1313	122

ALTURA XXL SOLO CROMO

Descripción	Ref.	Puntos
Ancho < 80 cm Altura de 195 hasta 220 cm	1355H2	350

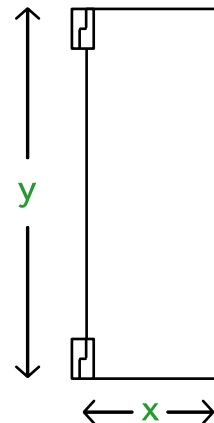

KITS PERFILERÍA Y HERRAJES SCREEN

KIT PERFIL + BRAZO SCREEN

CROMO	NEGRO	BLANCO	Puntos	
5184	5185	5183	84	
ORO	COBRE	NÍQUEL	TITANIO	Puntos
5186	5188	5189	5187	106

Estos kits ya van incluidos en las referencias de las tablas superiores

BISAGRAS MÓVIL 180°

CROMO	NEGRO	BLANCO	Puntos	
0330	0330NG	0330BL	80	
ORO	COBRE	NÍQUEL	TITANIO	Puntos
0330OR	0330CB	0330NK	0330T	93



Estos kits ya van incluidos en las referencias de las tablas superiores





PLAZO MEDIO DE ENTREGA 15 DÍAS (No se aceptarán devoluciones ni anulaciones de cristales a medida)

TUBOS COMPENSACIÓN MONTAJE (INCLUYE TAPA Y HERRAJES)

Descripción	Referencias	Puntos
Tubo compensación 40x20x2000 mm cromo	0001	33
Tubo compensación 40x40x2000 mm cromo	0002	38
Tubo compensación 40x40x2000 mm negro mate	0002N	38
Tubo compensación 40x40x2000 mm blanco	0002B	38
Tubo compensación 40x40x2000 mm oro	0002OR	45
Tubo compensación 40x40x2000 mm cobre	0002CB	45
Tubo compensación 40x40x2000 mm níquel	0002NK	45
Tubo compensación 40x40x2000 mm titanio	0002T	45
Tubo compensación 40x60x2000 mm cromo	0003	43
Ángulo 30x30x2000 mm cromo	0004	28
Tubo compensación INOX 40x20x2000 mm	0009	60
Tubo compensación INOX 40x40x2000 mm	0010	90

PERFILERÍA Y HERRAJES PARA LATERALES FIJOS A MEDIDA

Descripción	 CROMO	 NEGRO	 BLANCO	Puntos
Fijos STD	0821	9023	-	59
Trio	0006	0006N	-	102
Spazio hasta 90cm	0825	0825N	-	90
Spazio hasta 120cm	0826	0826N	-	135
Moving	1081	-	-	153
Vetrum	1080	-	-	133
Futura	5328	-	-	135
Temple	5128	-	-	81
Bypass	1277	-	-	116
Basic	5528	5492	5588	85
Twenty	2025	2026	-	80/85
Kenna	6564	6564N	-	88/93

Descripción	 ORO	 COBRE	 NÍQUEL	 TITANIO	Puntos
Basic	5445	5597	5469	5567	120
Kenna	6564OR	-	-	-	111
Twenty	2027	2028	-	-	95

*Incluye todo excepto el cristal

OPCIONES MAMPARAS



REF. 1731 / 1732 TIRADOR EXTRAPLANO: Gana 7 cm de paso de entrada en medidas intermedias y 2 cm en el resto.



REF. 1221 IMÁN DE EXPANSIÓN +1,2 OPEN: juego de imanes magnéticos más anchos que permiten aumentar el rango de la combinación +1,2 cm.



REF. 1072 OPCIÓN CIERRE PERFIL+JUNTA BURBUJA: Sistema de cierre con perfil en "U" a pared y goma anti golpes en puerta "C".



REF. 0007 EMBELLECEDOR ALUMINIO TRIO/BASIC: Pletina de aluminio pulido para cubrir el espacio entre el límite del plato y el perfil de cierre. Se usa cuando la cerámica es distinta en el interior de la mampara. Dimensiones 195x3,8 cm.



REF. 0008 EMBELLECEDOR ACERO FUTURA/TEMPLE: Pletina de acero pulido para cubrir el espacio entre el límite del plato y el perfil de cierre. Se usa cuando la cerámica es distinta en el interior de la mampara. Dimensiones 195x3,8 cm.



REF. 1222 PERFIL EXPANSIÓN PUERTA OPEN: Perfil en forma de H que se usa como compensación del perfil de las puertas Open y Glass plegable. La ref. 1222 también hace posible la unión del perfil de la puerta a los laterales fijos STD.



REF. 1215 PERFIL PUERTA OPEN: sustituyendo el perfil 1211 por este perfil se reduce hasta 1 cm el rango de la combinación.

REF. 1075 PERFIL UNIÓN FIJO+LATERAL FIJO: En **Vetrum y Moving** permite la instalación del lateral fijo al fijo del frontal en lugar de a la puerta (foto). Solo válido para laterales fijos a medida, si se aplica para un lateral fijo de serie perderá 5 cm de rango. En **Temple/Basic** no altera ni las referencias ni los rangos de la combinación puerta-fijo, por lo que solo se deberá indicar la posición dónde va a instalarse el fijo. En serie **Screen** permite unir 2 fijos al vértice.

RECAMBIOS MAMPARAS

En el siguiente código QR os mostramos los despieces de los distintos formatos de nuestras mamparas, separados por modelos, para facilitar la identificación de la pieza que necesita



GME BASIC TITANIO

TUO-CORRIERA **FRONTE-LAZ FIJO**

2TUO-2CORRIERAS **FREE**

FIJO-CORRIERAS-FIJO **ANGULAR AL VÉRTICE**

REPUESTOS

GME BASIC TITANIO 1F+1C

Ref.	Imagen	Q	Ref.	Imagen	Q	Ref.	Imagen	Q	Ref.	Imagen	Q
B400		1	B401		1	B402		1	B403		1
B404		1	B405		1	B406		1	B407		1
B408		1	B409		1	B410		1	B411		1
B412		1	B413		1	B414		1	B415		1

REPUESTOS

GME BASIC TITANIO SPAZIO 2F+2C

Ref.	Imagen	Q	Ref.	Imagen	Q	Ref.	Imagen	Q	Ref.	Imagen	Q
B420		1	B421		1	B422		1	B423		1
B424		1	B425		1	B426		1	B427		1
B428		1	B429		1	B430		1	B431		1
B432		1	B433		1	B434		1	B435		1

REPUESTOS

GME BASIC TITANIO

BASIC 1F+1C + LAZ FIJO **BASIC 1F+1C FREE**

A **B**

Ref.	Imagen	Q	Ref.	Imagen	Q	Ref.	Imagen	Q	Ref.	Imagen	Q
B440		1	B441		1	B442		1	B443		1
B444		1	B445		1	B446		1	B447		1
B448		1	B449		1	B450		1	B451		1
B452		1	B453		1	B454		1	B455		1

REPUESTOS

GME BASIC TITANIO ANGULAR 2F+2C

Ref.	Imagen	Q	Ref.	Imagen	Q	Ref.	Imagen	Q	Ref.	Imagen	Q
B460		1	B461		1	B462		1	B463		1
B464		1	B465		1	B466		1	B467		1
B468		1	B469		1	B470		1	B471		1
B472		1	B473		1	B474		1	B475		1

REPUESTOS

GME BASIC CRISTALES FIJOS Y CORRIERAS

Modelo	INCRUSTANTE				CORRIERAS			
	1	2	3	4	1	2	3	4
Modelo 1	1000	1500	2000	2500	1000	1500	2000	2500
Modelo 2	1000	1500	2000	2500	1000	1500	2000	2500
Modelo 3	1000	1500	2000	2500	1000	1500	2000	2500
Modelo 4	1000	1500	2000	2500	1000	1500	2000	2500

REPUESTOS

MEDIDAS Y PRECIOS DE PERFILERÍA (cm)

PERFILES VERTICALES DE PARED DEL FIJO

AKTUAL / PRESTIGE AKORD/GLASS	VETRUM	MOVING	FUTURA / TEMPLE	BASIC	OPEN/GLASS SPAZIO	KENNA
PA3F / PA3U / 26p / 26p	VE12 / 36p	MO17 / 36p	FTR3 / 36p	B03C* / 28p	OP4C* / 29p	K040 / 30p
TWENTY	SCREEN CROMO	GLASS				
TW30C* / 28p	S01C* / 19p	G014C* / G015C* 29p / 39p				

PERFILES VERTICALES DE PARED DEL CIERRE DE LA PUERTA





VETRUM MOVING	FUTURA	BASIC TEMPLE	OPEN GLASS	TRIO	BYPASS	PRESTIGE	KENNA
VE11 / 28p	F007 / 38p	B07C* / 38p	R195C* / 14p	TR20* / TR19* 33p / 29p	BY12 / 65p	PA05 / 56p	K040* / 30p

PERFILES HORIZONTALES SUPERIORES





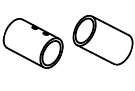

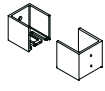
TEMPLE	BASIC	FUTURA	BYPASS	TRIO	
Alto 4,2 Ancho 1,3	Alto 4,8 Ancho 2,3	Alto 2,5 Ancho 3,1	Alto 4 Ancho 6	Alto 5,7 Ancho 5,7	
TE21C180 / 107p	B21C*210 / 85p	F21C210 / 105p	BY74 / 103p	TR246* / 111p	
AKTUAL PRESTIGE	MOVING	TWENTY	SPAZIO	PUERTA DE PASO	
Alto 4,5 Ancho 2	Ø2,5	Alto 2 Ancho 3,1	Alto 4 Ancho 2,5		
A599 / 70p	MO180 / 150p	TW190C* / 82p	SP02C* / 45p	PP85C* / 85p	PP8C* / 65p

*Si el repuesto es de un modelo disponible en varios colores, acompaña la referencia de la sigla correspondiente al color:
C - CROMO | **N** - NEGRO | **B** - BLANCO | **O** - ORO | **CB** - COBRE | **NK** - NÍQUEL | **T** - TITANIO

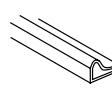
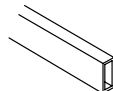

SOPORTES DE PARED

TEMPLE	BASIC	FUTURA	MOVING	BYPASS	TRIO
					
Alto 5,4 Ancho 3,8	Alto 5,8 Ancho 5,2	Alto 3,5 Ancho 6	Ø3	Alto 5,4 Ancho 7	Alto 6,2 Ancho 6,6
TE14 / 18p	B15C* / 18p	F15 / 18p	MO09 / 16p	BY09 / 20p	TR8* / 20p





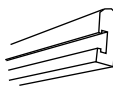

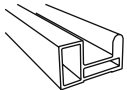
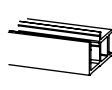

PERFILES HORIZONTALES INFERIORES (VIERTEAGUAS METÁLICAS)

FUTURA/TEMPLE BASIC/GLASS	MOVING	BYPASS	TRIO	AKTUAL	VETRUM	OPEN	GLASS PLEGABLE
							
1x0,6 cm	0,9x0,9 cm	1,6x1,1 cm	1,1x1 cm	0,8x1,2 cm	1,8x0,8 cm	0,6x0,6 cm	1x0,5 cm
B12C*210 / 19p	MO15 / 28p	BY07 / 28p	TR1395* / 16p	A011 / 19p	VE08 / 68p	OP6C* / 16p	GP08* / 16p



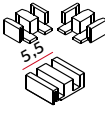

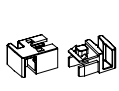
PERFILES HORIZONTALES INFERIORES

VITRO	TWENTY (frontal)	TWENTY (vértice y 2f+2c)	KENNA
			
1x2,3 cm	1,6x0,9 cm	1,6x0,9 cm	1,6x2,9 cm
VI14 210 / 80p	TW2C* / 16p	TW44C* / 38p	K120* / 65p

GUÍAS INFERIORES

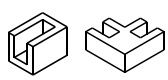
FUTURA	TEMPLE BASIC	MOVING	AKTUAL	VETRUM	BYPASS	TRIO	TWENTY	PTA. PASO
								
F011 / 37p	G10C* / 37p	MO14 / 28p	A009 / 13p	VE07 31p	BY5 / BY08 13p / 41p	TR12* 28p	TW14C* / TW15C* 16p / 16p	PP9C* / 8p

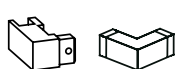
CANTONERAS INFERIORES

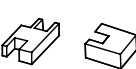
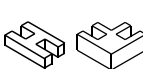
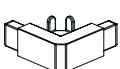





FUTURA TEMPLE/BASIC	MOVING	VETRUM	TRIO	OPEN	GLASS	TWENTY
						
B29C* / B42C* 12p / 12p	MO22 / 16p	VE44 / VE90 16p / 16p	TR37* / 12p	OP3C* / 8p	G009* / G011* 10p / 10P	TW43C* / 16p

*Si el repuesto es de un modelo disponible en varios colores, acompañe la referencia de la sigla correspondiente al color:
C - CROMO | **N** - NEGRO | **B** - BLANCO | **O** - ORO | **CB** - COBRE | **NK** - NÍQUEL | **T** - TITANIO







GOMAS

GOMAS DE CIERRE BURBUJA







GOMAS DE IMAN ADHESIVAS

FUTURA/TEMPLE/BASIC	TRIO	SPAZIO	FUTURA/TEMPLE/BASIC/TRIO	KENNA	SPAZIO
					
B006 / 8p	TR16 / 8p	SP13* / 10p	B027 / B66C* / B65C* / 12p / 15p / 12p	K220 / 21p	SP12* / 20p





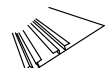



GOMAS DE CIERRE DE IMÁN

FUTURA / TEMPLE BASIC	VETRUM	MOVING	AKTUAL /PRESTIGE	OPEN / GLASS	KENNA	TWENTY
						
B036 / 16p	VE14 / 21p	MO20 / 19p	A017 / A007 13p / 13p	OP2C* / 16p	K180 / 16p	TW10 / 16p







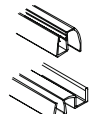

GOMAS VIERTEAGUAS VERTICALES

FUTURA /TEMPLE BASIC/GLASS/TWENTY	VETRUM	MOVING	AKTUAL/PRESTIGE	AKORD	KENNA	
			 8/6mm			
B005 / 12p	VE19 / 16p	MO19 / 17p	A006 / A008 8p / 10p	AK06 / 18p	K070 / 10p	K080 / 12p







GOMAS DE PRESIÓN

FUTURA TEMPLE / BASIC	VETRUM	MOVING	AKTUAL	SCREEN	OPEN / GLASS	KENNA	TWENTY	SPAZIO
								
B004 / 8p	VE15 / 8p	MO18 / 8p	A013 / 8p	S002 / 8p	OP05 / 8p	K050 / 8p	TW08 / 8p	SP19 / 8p

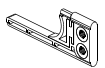

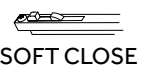

GOMAS VIERTEAGUAS INFERIORES

FUTURA TEMPLE / BASIC	TRIO	TWENTY	AKTUAL	BYPASS	OPEN GLASS	PANEL OPEN	PANEL GLASS	KENNA
								
B011 / 12p	TR28 / TR11 12p / 16p	TW41 / 16p	A010 / 12p	BY06 / 12p	OP07 / 12p	GB06 / 12p	G012 / 12p	K150 / 12p

FRENOS DE PUERTA

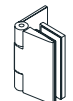

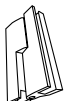

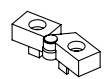

FUTURA	TEMPLE	MOVING	BASIC	AKTUAL PRESTIGE	KENNA	TWENTY	PTA. PASO
						 SOFT CLOSE	
F019 / 12p	TE15 / 7p	M010 / 18p	B22C* / 7p	PA1 / 5p	K290 / 10p	TW28 / 26p	PP11 / 12P

BISAGRAS



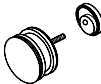

GLASS	GLASS	GLASS PLEGABLE	SCREEN BISAGRA	SCREEN/OPEN	AKORD
					
HG07* / 42p	G16C* / 47p	HM03* / 42p	S31C* / 42p	HU01C* / 17p	AK21 / 23p

*Si el repuesto es de un modelo disponible en varios colores, acompañe la referencia de la sigla correspondiente al color:
C - CROMO | **N** - NEGRO | **B** - BLANCO | **O** - ORO | **CB** - COBRE | **NK** - NÍQUEL | **T** - TITANIO



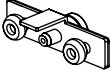

RODAMIENTOS (PUNTOS POR UNIDAD)



FUTURA	TEMPLE	VETRUM	MOVING	BASIC	SPAZIO	AKTUAL
						
F014 / 30p	TE13 / 23p	VE10 / 35p	MO12 / 45p	B013 / 15p	SP06C* / 60p	A016 / 15p

RODAMIENTOS (PUNTOS POR UNIDAD)



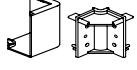

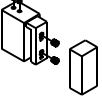
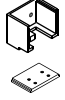
KENNA	TWENTY	PRESTIGE	AKORD	BYPASS	PTA. DE PASO	
						
K300* / 26p	TW25C* / 16p	TW45C* / 26p	P010 / P007 15p / 15p	AK19 / 17p	BY11 / 26p	PP04 / 17p

CANTONERAS SUPERIORES (ENTRADA AL VÉRTICE)



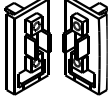

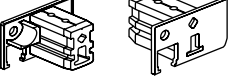

FUTURA	TEMPLE	MOVING	BASIC	TWENTY	AKTUAL PRESTIGE
					
F022 / 23p	TE25 / 23p	MO23 / 20p	B25C* / 23p	TW27C* / 16p	PA 17 / PA16 / 10p / 10p

TEMPLE	BASIC	BYPASS	TRIO
			
TE44 / TE31 / 26p	B44C* / B31C* / 26p	BY16 / 35p	TR8* / 20p

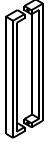
TOPES DE GUÍA (PUNTOS POR UNIDAD)

AKTUAL / PRESTIGE	KENNA	TWENTY	PTA. DE PASO
			
PA02 / 8p	K09 / 10p	TW24C* / 10p	PP10C* / 16p

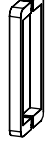
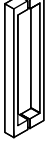
TIRADORES

ROTARY / TEMPLE / BASIC GLASS / FUTURA / AKTUAL PRESTIGE	MOVING	VETRUM	BYPASS	TRIO	KENNA	TWENTY	PTA. DE PASO	OPEN
								
22x2,5 cm	21x4 cm	42x2 cm	22x1 cm	28x3 cm	22x4,5 cm	22,5x3 cm		28x3 cm
T22C* / 23p	MO13 23p	VE06 35p	BY04 23p	T28C* 25p	K200* 23p	TW29C* 23p	PP6C* 48p	T28C* 23p

*Si el repuesto es de un modelo disponible en varios colores, acompañe la referencia de la sigla correspondiente al color:
C - CROMO | **N** - NEGRO | **B** - BLANCO | **O** - ORO | **CB** - COBRE | **NK** - NÍQUEL | **T** - TITANIO

REPUESTOS	OPEN	OPEN FROST	OPEN NEGRA	GLASS PLEGABLE
Cristal Fijo de 20	99			150
Cristal Fijo de 25	104			160
Cristal Fijo de 30	109	124	119	170
Cristal Fijo de 40	118	133	128	180
Cristal Fijo de 50	130	145	140	190
Cristal Fijo de 60	138	153	148	
Puerta de 30				
Puerta de 35				
Puerta de 40	160			
Puerta de 45	170			
Puerta de 50	180	200	190	
Puerta de 55	190	210	200	
Puerta de 60	200	220	210	
Puerta de 65	210	230	220	
Puerta de 70	215	235	225	
Puerta de 75	220	240	230	
Puerta de 80	225	245	235	
Puerta de 85	234	254	244	

REPUESTOS TRIO	FIJO	INTERM.	PUERTA
Frontal de 90	92	78	80
Frontal de 95	95	81	83
Frontal de 100	98	84	87
Frontal de 105	101	88	90
Frontal de 110	104	92	94
Frontal de 115	107	95	97
Frontal de 120	111	98	100
Frontal de 125	114	101	103
Frontal de 130	117	104	106
Frontal de 135	120	107	110
Frontal de 140	123	111	113
Frontal de 145	126	114	116
Frontal de 150	130	117	119
Frontal de 155	133	120	122
Frontal de 160	136	123	125
Rodamientos Trio		22	24

RECAMBIOS BYPASS	Puntos
Puerta Bypass 120	141
Puerta Bypass 130	147
Puerta Bypass 140	154
Puerta Bypass 150	160
Puerta Bypass 160	166

	VETRUM	MOVING	AKTUAL		PRESTIGE	
	TRANSP	TRANSP	TRANSP	F.PLUS	TRANSP	F.PLUS
Cristal Fijo lado de 70	218	147	105	120	91	106
Cristal Fijo lado de 75					93	108
Cristal Fijo lado de 80	224	156	114	129	95	110
Cristal Fijo lado de 90	230	164	127	142	100	115
Cristal Fijo lado de 100	235	173	136	151	105	120
Cristal Fijo lado de 110	241	180	149	164	109	124
Cristal Fijo lado de 120	246	189	159	174	113	128
Cristal Fijo lado de 130	256	197	168	183	117	132
Cristal Fijo lado de 140	267	206	178	193	121	136
Cristal Fijo lado de 150	278	214	188	203	125	140
Cristal Fijo lado de 160	289	223	196	211	128	143
Cristal Fijo lado de 170	300	232	206	221	133	148
Cristal Fijo lado de 180	310	241				
Corredera lado de 70	215	156	106	121	76	91
Corredera lado de 75	215	156			78	94
Corredera lado de 80	220	169	114	129	82	97
Corredera lado de 90	226	178	124	139	88	103
Corredera lado de 100	232	191	134	149	93	108
Corredera lado de 110	237	199	143	158	99	114
Corredera lado de 120	243	210	151	166	106	121
Corredera lado de 130	253	218	160	175	112	127
Corredera lado de 140	264	227	168	183	117	132
Corredera lado de 150	274	236	177	192	123	138
Corredera lado de 160	286	245	186	201	129	144
Corredera lado de 170	297	253	197	212	136	151
Corredera lado de 180	307	262				
Cristal lateral fijo 70	217	204	186	201	186	201
Cristal lateral fijo 75	229	217	190	205	190	205
Cristal lateral fijo 80	239	229	196	211	196	211
Cristal lateral fijo 90	250	241	207	222	207	222

RECAMBIOS PANELES DE BAÑERA	Puntos
Bisagra Glass (1 uni)	42
Brazo soporte bañera Open	38
Cristal fijo Open bañera	70
Puerta Open bañera	103
Bisagra Open	17

REC. SCREEN CR	Puntos
Goma vertical	8
Goma inferior	6
Perfil a pared	16
Perfil corner	40
Bisagra sup/inf moving	17
Pinza brazos	8

BRAZOS SUJECIÓN	Puntos
Vetrum brazo lateral	52
Vetrum brazo frontal	76
Open	32
Glass	32
Vitro brazo frontal	42
Vitro brazo lateral	66
Vitro brazo vértice	32
Kenna brazo frontal	42
Kenna brazo lateral	66

SERÁ NECESARIO INDICAR MODELO Y REFERENCIA DE LA MAMPARA
PARA CURSAR PEDIDO DE CUALQUIER REPUESTO

DESPIECE REFERENCIA /PUNTO

SERIES BASIC BAÑERA

FIJO + PUERTA

	TRANSPARENTE		FROST PLUS	
	Ref.	Puntos	Ref.	Puntos
CRISTALES FIJO+PTA 140-145 BAÑERA	5050	149	6050	165
CRISTALES FIJO+PTA 145-150 BAÑERA	5051	153	6051	172
CRISTALES FIJO+PTA 150-155 BAÑERA	5052	158	6052	176
CRISTALES FIJO+PTA 155-160 BAÑERA	5053	161	6053	182
CRISTALES FIJO+PTA 160-165 BAÑERA	5054	167	6054	185
CRISTALES FIJO+PTA 165-170 BAÑERA	5055	172	6055	191
CRISTALES 2F+2C FIJO+PTA 80-85 BAÑERA	5060	86	6060	96
CRISTALES 2F+2C FIJO+PTA 85-90 BAÑERA	5062	91	6062	101
CRISTALES 2F+2C FIJO+PTA 90-95 BAÑERA	5061	95	6061	105

FIJOS

	TRANSPARENTE		FROST PLUS	
	Ref.	Puntos	Ref.	Puntos
CRISTAL FIJO FRONTAL BAÑERA 5050 (71,5cm)	F5050	95	F6050	105
CRISTAL FIJO FRONTAL BAÑERA 5051 (71,5cm)	F5051	95	F6051	105
CRISTAL FIJO FRONTAL BAÑERA 5052 (76,5cm)	F5052	100	F6052	110
CRISTAL FIJO FRONTAL BAÑERA 5053 (76,5cm)	F5053	100	F6053	110
CRISTAL FIJO FRONTAL BAÑERA 5054 (86,5cm)	F5054	105	F6054	115
CRISTAL FIJO FRONTAL BAÑERA 5055 (86,5cm)	F5055	105	F6055	115
CRISTAL FIJO FRONTAL BAÑERA 5060 (39,6cm)	F5060	65	F6060	75
CRISTAL FIJO FRONTAL BAÑERA 5062 (39,6cm)	F5062	65	F6062	75
CRISTAL FIJO FRONTAL BAÑERA 5061 (44,6cm)	F5061	75	F6061	85

PUERTAS

	TRANSPARENTE		FROST PLUS	
	Ref.	Puntos	Ref.	Puntos
CRISTAL PUERTA FRONTAL BAÑERA 5050 (72,3cm)	P5050	100	P6050	120
CRISTAL PUERTA FRONTAL BAÑERA 5051 (77,3cm)	P5051	105	P6051	125
CRISTAL PUERTA FRONTAL BAÑERA 5052 (77,3cm)	P5052	105	P6052	125
CRISTAL PUERTA FRONTAL BAÑERA 5053 (82,3cm)	P5053	110	P6053	130
CRISTAL PUERTA FRONTAL BAÑERA 5054 (77,3cm)	P5054	105	P6054	125
CRISTAL PUERTA FRONTAL BAÑERA 5055 (82,3cm)	P5055	110	P6055	130
CRISTAL PUERTA FRONTAL BAÑERA 5060 (40,4cm)	P5060	70	P6060	85
CRISTAL PUERTA FRONTAL BAÑERA 5062 (45,4cm)	P5062	80	P6062	95
CRISTAL PUERTA FRONTAL BAÑERA 5061 (45,4cm)	P5061	80	P6061	95

BASIC PERFILERÍA Y HERRAJES CROMO

	Ref.	Puntos
KIT 1F+1C HASTA 180 cm	5458	184
KIT 2F+2C HASTA 182 cm	5459	241

DESPIECE REFERENCIA /PUNTO

SERIES BASIC/FUTURA/TEMPLE/SCREEN

FIJO + PUERTA

	TRANSPARENTE		FROST PLUS	
	Ref.	Puntos	Ref.	Puntos
Cristales Fijo + Puerta lado de 65-70	5018	116	6018	137
Cristales Fijo + Puerta lado de 70-75	5029	121	6029	143
Cristales Fijo + Puerta lado de 75-80	5019	126	6019	147
Cristales Fijo + Puerta lado de 80-85	5030	132	6030	153
Cristales Fijo + Puerta lado de 85-90	5020	137	6020	158
Cristales Fijo + Puerta lado de 90-95	5031	140	6031	163
Cristales Fijo + Puerta lado de 95-100	5021	142	6021	169
Cristales Fijo + Puerta lado de 115-120	5022	163	6022	200
Cristales Fijo + Puerta frontal de 95-100	5001	145	6001	172
Cristales Fijo + Puerta frontal de 100-105	5002	152	6002	179
Cristales Fijo + Puerta frontal de 105-110	5003	158	6003	185
Cristales Fijo + Puerta frontal de 110-115	5004	163	6004	192
Cristales Fijo + Puerta frontal de 115-120	5005	167	6005	199
Cristales Fijo + Puerta frontal de 120-125	5006	174	6006	206
Cristales Fijo + Puerta frontal de 125-130	5007	179	6007	213
Cristales Fijo + Puerta frontal de 130-135	5008	183	6008	218
Cristales Fijo + Puerta frontal de 135-140	5009	189	6009	225
Cristales Fijo + Puerta frontal de 140-145	5010	194	6010	232
Cristales Fijo + Puerta frontal de 145-150	5011	199	6011	239
Cristales Fijo + Puerta frontal de 150-155	5012	206	6012	246
Cristales Fijo + Puerta frontal de 155-160	5013	211	6013	253
Cristales Fijo + Puerta frontal de 160-165	5014	215	6014	257
Cristales Fijo + Puerta frontal de 165-170	5015L	217	6015L	276
Cristales Fijo + Puerta frontal de 170-175	5016L	223	6016L	284
Cristales Fijo + Puerta frontal de 175-180	5017L	229	6017L	291
Cristales Fijo + Puerta frontal de 180-190	5023L	239	6023L	306
Cristales Fijo + Puerta frontal de 190-200	5024L	250	6024L	321

CRISTALES LAT. FIJOS Y SCREEN

Lateral fijo de 70	5025	120	6025	140
Lateral fijo de 75	5057	125	6057	145
Lateral fijo de 80	5026	130	6026	150
Lateral fijo de 90	5027	145	6027	165
Lateral fijo de 100	5033	160	6033	180
Lateral fijo de 110	5034	175	6034	195
Lateral fijo de 120	5035	190	6035	210

BASIC PERFILERÍA Y HERRAJES

	CROMO	NEGRO	BLANCA	Puntos	ORO	NÍQUEL	COBRE	TITANIO	Puntos
	Ref.	Ref.	Ref.		Ref.	Ref.	Ref.	Ref.	
KIT VÉRTICE 120X90	5423	5490	5580	245	5448	5463	5590	5563	330
KIT VÉRTICE 140X100	5424	5491	5581	255	5449	5464	5591	5564	340
KIT 1F+1C HASTA 140	5434	5493	5583	176	5440	5460	5592	5560	210
KIT 1F+1C HASTA 180	5438	5494	5584	184	5441	5461	5593	5561	217
KIT 1F+1C HASTA 200	5446	5495	5585	201	5442	5462	5594	5562	230
KIT 2F+2C HASTA 172	5451	5496	5586	237	5498	5465	5595	5565	270
KIT 2F+2C HASTA 210	5454	5497	5587	241	5499	5466	5596	5566	300
KIT LATERAL FIJO	5444	5492	5588	85	5445	5469	5597	5567	120

FIJOS (solo cristal)

	TRANSPARENTE		FROST PLUS	
	Ref.	Puntos	Ref.	Puntos
CRISTAL FIJO LADO 5018 (29,6cm)	5018F	65	6018F	89
CRISTAL FIJO LADO 5029 (34,6cm)	5029F	70	6029F	86
CRISTAL FIJO LADO 5019 (34,6cm)	5019F	70	6019F	96
CRISTAL FIJO LADO 5030 (39,6cm)	5030F	75	6030F	90
CRISTAL FIJO LADO 5020 (39,6cm)	5020F	75	6020F	100
CRISTAL FIJO LADO 5031 (44,6cm)	5031F	80	6031F	99
CRISTAL FIJO LADO 5021 (44,6cm)	5021F	80	6021F	110
CRISTAL FIJO LADO 5022 (54,6cm)	5022F	95	6022F	122
CRISTAL FIJO FRONTAL 5001 (46,5cm)	5001F	84	6001F	99
CRISTAL FIJO FRONTAL 5002 (51,5cm)	5002F	90	6002F	105
CRISTAL FIJO FRONTAL 5003 (51,5cm)	5003F	90	6003F	105
CRISTAL FIJO FRONTAL 5004 (56,5cm)	5004F	100	6004F	111
CRISTAL FIJO FRONTAL 5005 (56,5cm)	5005F	100	6005F	111
CRISTAL FIJO FRONTAL 5006 (61,5cm)	5006F	105	6006F	117
CRISTAL FIJO FRONTAL 5007 (61,5cm)	5007F	105	6007F	117
CRISTAL FIJO FRONTAL 5008 (66,5cm)	5008F	109	6008F	124
CRISTAL FIJO FRONTAL 5009 (66,5cm)	5009F	109	6009F	124
CRISTAL FIJO FRONTAL 5010 (71,5cm)	5010F	113	6010F	130
CRISTAL FIJO FRONTAL 5011 (71,5cm)	5011F	113	6011F	130
CRISTAL FIJO FRONTAL 5012 (76,5cm)	5012F	116	6012F	139
CRISTAL FIJO FRONTAL 5013 (76,5cm)	5013F	116	6013F	139
CRISTAL FIJO FRONTAL 5014 (86,5cm)	5014F	121	6014F	145
CRISTAL FIJO FRONTAL 5015 (86,5cm)	5015F	121	6015F	152
CRISTAL FIJO FRONTAL 5016 (91,5cm)	5016F	129	6016F	162
CRISTAL FIJO FRONTAL 5017 (96,5cm)	5017F	133	6017F	169
CRISTAL FIJO FRONTAL 5023 (106,5cm)	5023F	146	6023F	173
CRISTAL FIJO FRONTAL 5024 (116,5cm)	5024F	156	6024F	185

PUERTAS (solo cristal)

	TRANSPARENTE		FROST PLUS	
	Ref.	Puntos	Ref.	Puntos
CRISTAL PUERTA LADO 5018 (35,4cm)	P5018	71	P6018	79
CRISTAL PUERTA LADO 5029 (35,4cm)	P5029	71	P6029	86
CRISTAL PUERTA LADO 5019 (40,4cm)	P5019	75	P6019	86
CRISTAL PUERTA LADO 5030 (40,4cm)	P5030	75	P6030	90
CRISTAL PUERTA LADO 5020 (45,4cm)	P5020	84	P6020	90
CRISTAL PUERTA LADO 5031 (45,4cm)	P5031	84	P6031	99
CRISTAL PUERTA LADO 5021 (50,4cm)	P5021	90	P6021	99
CRISTAL PUERTA LADO 5022 (60,4cm)	P5022	98	P6022	111
CRISTAL PUERTA FRONTAL 5001 (52,3cm)	P5001	89	P6001	99
CRISTAL PUERTA FRONTAL 5002 (52,3cm)	P5002	89	P6002	99
CRISTAL PUERTA FRONTAL 5003 (57,3cm)	P5003	98	P6003	105
CRISTAL PUERTA FRONTAL 5004 (57,3cm)	P5004	98	P6004	105
CRISTAL PUERTA FRONTAL 5005 (62,3cm)	P5005	107	P6005	111
CRISTAL PUERTA FRONTAL 5006 (62,3cm)	P5006	107	P6006	111
CRISTAL PUERTA FRONTAL 5007 (67,3cm)	P5007	114	P6007	117
CRISTAL PUERTA FRONTAL 5008 (67,3cm)	P5008	114	P6008	117
CRISTAL PUERTA FRONTAL 5009 (72,3cm)	P5009	119	P6009	124
CRISTAL PUERTA FRONTAL 5010 (72,3cm)	P5010	119	P6010	124
CRISTAL PUERTA FRONTAL 5011 (77,3cm)	P5011	125	P6011	132
CRISTAL PUERTA FRONTAL 5012 (77,3cm)	P5012	125	P6012	132
CRISTAL PUERTA FRONTAL 5013 (82,3cm)	P5013	129	P6013	143
CRISTAL PUERTA FRONTAL 5014 (77,3cm)	P5014	125	P6014	132
	P5015	156	P6015	146
	P5016	156	P6016	146
PUERTA 5015/16/17/23/24B 165/200 TRANSPARENTE (82,3cm)	P5017	156	P6017	146
	P5023	156	P6023	146
	P5024	156	P6024	146

Despiece PUNTOS/REFERENCIA serie TWENTY

FIJO + PUERTA

	Ref.	Puntos
Cristales Fijo + Puerta lado de 65-70	2030	95
Cristales Fijo + Puerta lado de 70-75	2031	100
Cristales Fijo + Puerta lado de 75-80	2032	104
Cristales Fijo + Puerta lado de 80-85	2033	109
Cristales Fijo + Puerta lado de 85-90	2034	114
Cristales Fijo + Puerta lado de 90-95	2035	118
Cristales Fijo + Puerta lado de 95-100	2036	122
Cristales Fijo + Puerta lado de 115-120	2037	141
Cristales Fijo + Puerta frontal de 110-115	1999	131
Cristales Fijo + Puerta frontal de 115-120	2000	135
Cristales Fijo + Puerta frontal de 120-125	2001	139
Cristales Fijo + Puerta frontal de 125-130	2002	143
Cristales Fijo + Puerta frontal de 130-135	2003	147
Cristales Fijo + Puerta frontal de 135-140	2004	151
Cristales Fijo + Puerta frontal de 140-145	2005	155
Cristales Fijo + Puerta frontal de 145-150	2006	159
Cristales Fijo + Puerta frontal de 150-155	2007	164
Cristales Fijo + Puerta frontal de 155-160	2008	168
Cristales Fijo + Puerta frontal de 160-165	2009	172
Cristales Fijo + Puerta frontal de 165-170	2010	175
Cristales Fijo + Puerta frontal de 170-175	2011	180
Cristales Fijo + Puerta frontal de 175-180	2012	184

FIJOS (solo cristal)

	Ref.	Puntos
CRISTAL FIJO LADO 70 TWENTY (28.3cm)	F2030	65
CRISTAL FIJO LADO 75 TWENTY (30.8cm)	F2031	70
CRISTAL FIJO LADO 80 TWENTY (33.3cm)	F2032	75
CRISTAL FIJO LADO 85 TWENTY (35.8cm)	F2033	80
CRISTAL FIJO LADO 90 TWENTY (38.3cm)	F2034	85
CRISTAL FIJO LADO 95 TWENTY (40.8cm)	F2035	90
CRISTAL FIJO LADO 100 TWENTY (43.3cm)	F2036	95
CRISTAL FIJO LADO 120 TWENTY (53.3cm)	F2037	100
CRISTAL FIJO 115 TWENTY (51,8cm)	F1999	97
CRISTAL FIJO 120 TWENTY (54,3cm)	F2000	100
CRISTAL FIJO 125 TWENTY (56,8cm)	F2001	105
CRISTAL FIJO 130 TWENTY (59,3cm)	F2002	107
CRISTAL FIJO 135 TWENTY (61,8cm)	F2003	109
CRISTAL FIJO 140 TWENTY (64,3cm)	F2004	111
CRISTAL FIJO 145 TWENTY (66,8cm)	F2005	113
CRISTAL FIJO 150 TWENTY (69,3cm)	F2006	115
CRISTAL FIJO 155 TWENTY (71,8cm)	F2007	117
CRISTAL FIJO 160 TWENTY (74,3cm)	F2008	119
CRISTAL FIJO 165 TWENTY (76,8cm)	F2009	121
CRISTAL FIJO 170 TWENTY (79,3cm)	F2010	123
CRISTAL FIJO 175 TWENTY (81,8cm)	F2011	129
CRISTAL FIJO 180 TWENTY (84,3cm)	F2012	133

PUERTAS (solo cristal)

	Ref.	Puntos
CRISTAL PUERTA 115 TWENTY (58,8cm)	P1999	106
CRISTAL PUERTA 120 TWENTY (61,3cm)	P2000	109
CRISTAL PUERTA 125 TWENTY (63,8cm)	P2001	112
CRISTAL PUERTA 130 TWENTY (66,3cm)	P2002	115
CRISTAL PUERTA 135 TWENTY (68,8cm)	P2003	118
CRISTAL PUERTA 140 TWENTY (71,3cm)	P2004	121
CRISTAL PUERTA 145 TWENTY (73,8cm)	P2005	124
CRISTAL PUERTA 150 TWENTY (76,3cm)	P2006	127
CRISTAL PUERTA 155 TWENTY (78,8cm)	P2007	130
CRISTAL PUERTA 160 TWENTY (81,3cm)	P2008	133
CRISTAL PUERTA 165 TWENTY (83,8cm)	P2009	136
CRISTAL PUERTA 170 TWENTY (86,3cm)	P2010	139
CRISTAL PUERTA 175 TWENTY (88,8cm)	P2011	142
CRISTAL PUERTA 180 TWENTY (91,3cm)	P2012	145

TWENTY PERFILERÍA Y HERRAJES

	TWENTY CROMO		TWENTY NEGRO		TWENTY ORO		TWENTY COBRE	
	Ref.	Puntos	Ref.	Puntos	Ref.	Puntos	Ref.	Puntos
KIT VÉRTICE 120X90	2038	359	2039	373	2046	410	2062	410
KIT 1F+1C HASTA 150	2021	242	2023	253	2044	286	2060	286
KIT 1F+1C HASTA 180	2022	258	2024	274	2045	309	2061	309
KIT 2F+2C HASTA 190	2042	350	2043	364	2047	401	2063	401

Despiece PUNTOS/REFERENCIA serie KENNA

FIJO + PUERTA

	KENNA	
	Ref.	Puntos
CRISTALES FIJO + PUERTA LADO DE 65-70	6553C	172
CRISTALES FIJO + PUERTA LADO DE 70-75	6554C	178
CRISTALES FIJO + PUERTA LADO DE 75-80	6555C	185
CRISTALES FIJO + PUERTA LADO DE 80-85	6556C	188
CRISTALES FIJO + PUERTA LADO DE 85-90	6557C	198
CRISTALES FIJO + PUERTA LADO DE 90-95	6558C	205
CRISTALES FIJO + PUERTA LADO DE 95-100	6559C	211
CRISTALES FIJO + PUERTA LADO DE 115-120	6560C	246
CRISTALES FIJO + PUERTA FRONTAL DE 95-100	6530C	211
CRISTALES FIJO + PUERTA FRONTAL DE 100-105	6531C	223
CRISTALES FIJO + PUERTA FRONTAL DE 105-110	6532C	225
CRISTALES FIJO + PUERTA FRONTAL DE 110-115	6533C	227
CRISTALES FIJO + PUERTA FRONTAL DE 115-120	6534C	239
CRISTALES FIJO + PUERTA FRONTAL DE 120-125	6535C	247
CRISTALES FIJO + PUERTA FRONTAL DE 125-130	6536C	253
CRISTALES FIJO + PUERTA FRONTAL DE 130-135	6537C	261
LATERAL FIJO DE 70	6547C	121
LATERAL FIJO DE 75	6548C	128
LATERAL FIJO DE 80	6549C	135
LATERAL FIJO DE 90	6550C	148

FIJOS (solo cristal)

	Ref.	Puntos
CRISTAL FIJO KENNA 140 (64.3cm)	6538AC	110
CRISTAL FIJO KENNA 145 (69.3cm)	6539AC	116
CRISTAL FIJO KENNA 150 (69.3cm)	6540AC	123
CRISTAL FIJO KENNA 155 (74.3cm)	6541AC	129
CRISTAL FIJO KENNA 160 (76.8cm)	6542AC	136
CRISTAL FIJO KENNA 165 (81.8cm)	6543AC	144
CRISTAL FIJO KENNA 170 (86.8cm)	6544AC	150
CRISTAL FIJO KENNA 175 (91.8cm)	6545AC	157
CRISTAL FIJO KENNA 180 (96.8cm)	6546AC	164

PUERTAS (solo cristal)

	Ref.	Puntos
CRISTAL PUERTA KENNA 140/145 (73.5cm)	6539BC	175
CRISTAL PUERTA KENNA B 150/155 (78.5cm)	6541BC	183
CRISTAL PUERTA PUERTA KENNA 160/165/170/175/180 (81cm)	6546BC	190

KENNA PERFILERÍA Y HERRAJES

	KENNA CROMO		KENNA NEGRO		KENNA ORO	
	Ref.	Puntos	Ref.	Puntos	Ref.	Puntos
KIT VÉRTICE 120X120	6563	308	6563N	318	6563OR	389
KIT 1F+1C HASTA 140	6561	192	6561N	202	6561OR	242
KIT 1F+1C HASTA 180	6562	202	6562N	212	6562OR	253
KIT 2F+2C HASTA 210	6565	312	6565N	322	6565OR	393
KIT LATERAL FIJO	6564	88	6564N	93	6564OR	111

Modelos de vinilos poliméricos

PLAZO DE ENTREGA
1 SEMANA

TRAZOS



FROST PLUS



FROST



DESERT



METEOR



BAMBÚ



Impresión digital sobre vinilo

PLAZO DE ENTREGA
20 DÍAS LABORABLES

PERSONALICE SU MAMPARA

Gracias a las posibilidades que ofrecen las innovadoras técnicas de impresión digital, podemos dar personalidad a nuestras mamparas. Con este tipo de impresión, se puede dar al cristal una imagen única mediante la incorporación de fotografías, dibujos, logos, símbolos y mucho más. Además, nuestro sistema de impresión digital incorpora una lámina para la protección y conservación de la imagen del vinilo.

Si la imagen es una fotografía de cámara de fotos, se requiere una calidad mínima de 5Mpx y formato JPG.

Si se crea la imagen o es un archivo de imagen, se requiere una resolución mínima de 300dpi, formato JPG/EPS/PDF, color CMYK y un tamaño mayor del 70% del tamaño final de impresión (1Mpx/m²). También valen archivos vectoriales.



FRONTALES
220 puntos

ANGULARES
280 puntos



Plantilla cristales decorados vinilos

- A trazos E desert
 B frost plus F meteor
 C frost G bambú

Cliente
Modelo mampara
Descripción
Referencia

Formato

F: FIJO

P: PUERTA

FRONTAL

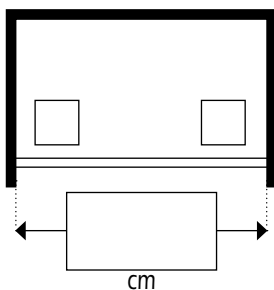

APERTURA VERTICE IZO

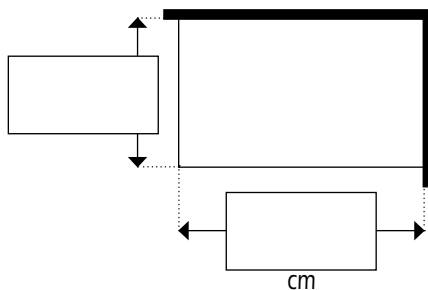

APERTURA VERTICE DER

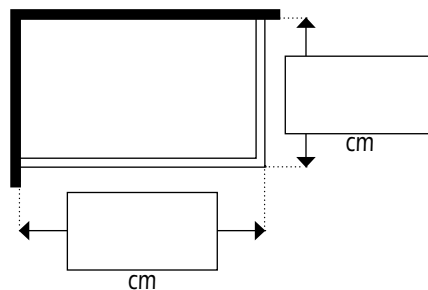

FRONTAL con LATERAL FIJO

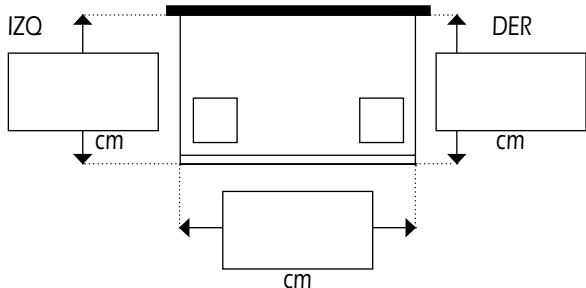

SEMICIRCULAR

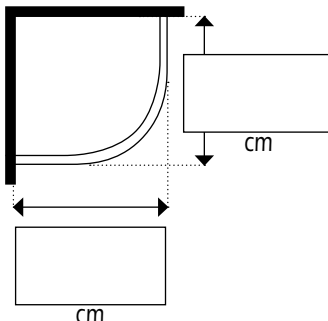

EJEMPLO FRONTAL

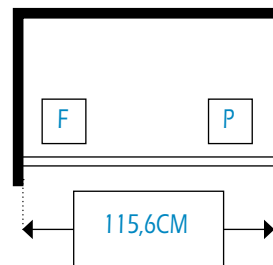

Altura decorado (max. 118cm)

		ref.	puntos
MONTAJE EN GME FROST / FROST PLUS ÁCIDO	FRONTALES	OFROST1	80
	ANGULARES	OFROST2	100
MONTAJE EN GME RESTO VINILOS	FRONTALES	0021	140
	ANGULARES	0020	200
MONTAJE EN GME IMPRESIÓN DIGITAL VINILOS	FRONTALES	0019	220
	ANGULARES	0018	280
SOLO VINILO, MONTAJE A CARGO DEL CLIENTE	FRONTALES	0023	60
	ANGULARES	0022	80



GME PRESENTA SU COLECCIÓN DE PLATOS DE DUCHA :

Ardesia / Style Plus:

Platos extraplano fabricados en resina con una nueva fórmula de carga mineral y gel coat sanitario de última generación que nos permite producir un plato con una reducción de peso considerable y una mayor resistencia a la torsión, manteniendo todas las ventajas de los platos en resina. Estos modelos se fabrican con **textura pizarra** y tienen un certificado antideslizamiento **clase 3**, así como una capa de Gel Coat de alta resistencia que evita posibles rayados y la aparición de organismos como hongos o moho.



CERTIFICADOS

Preocupados por la calidad que ofrecemos a nuestros clientes, GME DIVISIÓN BAÑOS SL dispone de certificados que garantizan la calidad de todos sus productos, los cuales cumplen con todas las normativas europeas.

Al mismo tiempo GME DIVISIÓN BAÑOS SL esta asociado a AIDIMME (Instituto tecnológico), en la cual se realizan inspecciones y ensayos de laboratorio para garantizar la calidad y buen funcionamiento de los productos que les ofrecemos.

Ardesia Plus

Carga mineral última generación, textura pizarra
Gel Coat Sanitario ISO NPG



Color carta RAL
+80 puntos
*Plazo de entrega 25 días

TABLA DISTANCIA A DESAGÜE

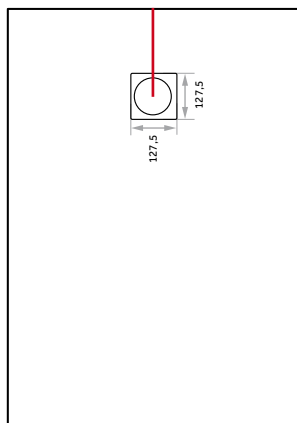

	ANCHO 70	ANCHO 75	ANCHO 80	ANCHO 90	ANCHO 100
90/100	30	30	30	30	30
110	40	35	40	35	35
120	35	35	35	35	35
130	40	40	40	40	40
140	45	40	45	40	40
150	40	45	40	40	40
160	45	50	45	45	45
170	45	50	50	50	45
180	50	50	50	50	50
190	50	52	57	60	50
200	50	52	57	50	50

80x80 / 90x90 / 100x100 y platos de largo mayor que 200 tienen desagüe en el centro



	BLANCO	GRAFITO	BEIGE	GRIS	Puntos
90x70	3886	3887	3888	3889	219
100x70	3900	3918	3936	3954	238
110x70	3901	3919	3937	3955	260
120x70	3902	3920	3938	3956	271
130x70	3903	3921	3939	3957	299
140x70	3904	3922	3940	3958	306
150x70	3905	3923	3941	3959	324
160x70	3906	3924	3942	3960	347
170x70	3907	3925	3943	3961	382
180x70	3908	3926	3944	3962	389
190x70	3972	3974	3976	3978	398
200x70	3973	3975	3977	3979	411
90x75	7500	7512	7524	7536	226
100x75	7501	7513	7525	7537	244
110x75	7502	7514	7526	7538	265
120x75	7503	7515	7527	7539	275
130x75	7504	7516	7528	7540	307
140x75	7505	7517	7529	7541	311
150x75	7506	7518	7530	7542	328
160x75	7507	7519	7531	7543	352
170x75	7508	7520	7532	7544	389
180x75	7509	7521	7533	7545	394
190x75	7510	7522	7534	7546	404
200x75	7511	7523	7535	7547	415
80x80	3830	3832	3834	3836	213
100x80	3909	3927	3945	3963	249
110x80	3910	3928	3946	3964	271
120x80	3911	3929	3947	3965	281
130x80	3912	3930	3948	3966	310
140x80	3913	3931	3949	3967	316
150x80	3914	3932	3950	3968	335
160x80	3915	3933	3951	3969	357
170x80	3916	3934	3952	3970	393
180x80	3917	3935	3953	3971	399
190x80	3980	3982	3984	3986	408
200x80	3981	3983	3985	3987	421

*Incluye válvula standard extraplana con fijación tornillos + rejilla Inox 316 color Inox de 2 mm

	BLANCO	GRAFITO	BEIGE	GRIS	Puntos
90x90	3831	3833	3835	3837	270
120x90	3840	3849	3858	3867	309
130x90	3841	3850	3859	3868	368
140x90	3842	3851	3860	3869	389
150x90	3843	3852	3861	3870	410
160x90	3844	3853	3862	3871	431
170x90	3845	3854	3863	3872	452
180x90	3846	3855	3864	3873	473
190x90	3847	3856	3865	3874	478
200x90	3848	3857	3866	3875	488
100x100	3700	3712	3724	3736	310
110x100	3701	3713	3725	3737	347
120x100	3702	3714	3726	3738	373
130x100	3703	3715	3727	3739	389
140x100	3704	3716	3728	3740	404
150x100	3705	3717	3729	3741	420
160x100	3706	3718	3730	3742	452
170x100	3707	3719	3731	3743	473
180x100	3708	3720	3732	3744	499
190x100	3709	3721	3733	3745	536
200x100	3710	3722	3734	3746	546
220x100	3711	3723	3735	3747	641

ARDESIA XXL

	Ref.	Puntos
Largo hasta 160 Ancho 120 cm	3990	599
Largo hasta 220 Ancho 70 a 90 cm	3998	680
Largo hasta 220 Ancho 120 cm	3991	896

Plazo de entrega medio 15 días
Desagüe central en XXL con ancho de 100 a 120 cm o largo de 200 a 220 cm.

PLATOS A MEDIDA Y CORTE

(necesario plano técnico)

- Cortes con acabado Gel Coat ref. 7777 / 25 puntos

*Plazo de entrega 7 días

- Cortes sin acabado Gel Coat ref. 8888 / gratuito

*Plazo de entrega 5 días

*Esta opción solo cuando el corte va oculto en la pared



REJILLAS COLOR PÁGINA SIGUIENTE

ARDESIA PLUS REJILLAS COLOR



REJILLA NEGRA
ref. 0382NG
+14 puntos



REJILLA BLANCA
ref. 0382BL
+14 puntos



REJILLA BEIGE
ref. 0382BE
+14 puntos



REJILLA GRIS
ref. 0382GR
+14 puntos

ARDESIA PLUS REJILLAS COLOR



REJILLA ORO
ref. 0382OR
+14 puntos



REJILLA COBRE
ref. 0382CB
+14 puntos



REJILLA NÍQUEL
ref. 0382NK
+14 puntos



REJILLA TITANIO
ref. 0382T
+14 puntos

Ardesia Plus Semicircular

Carga mineral última generación, textura pizarra
Gel Coat Sanitario ISO NPG



Cualquier otro color de la carta RAL +80 puntos
Se sirve con rejilla inox

Plazo medio de entrega 25 días

(No se aceptarán anulaciones una vez cursado el pedido)

A	B	C	R	Kg
800	800	320	550	18
900	900	370	550	19

Técnico

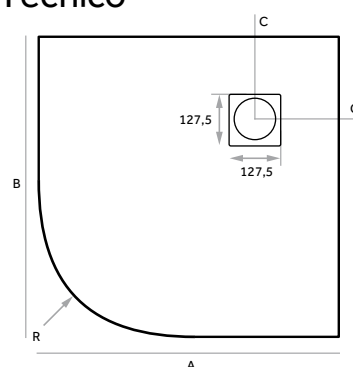

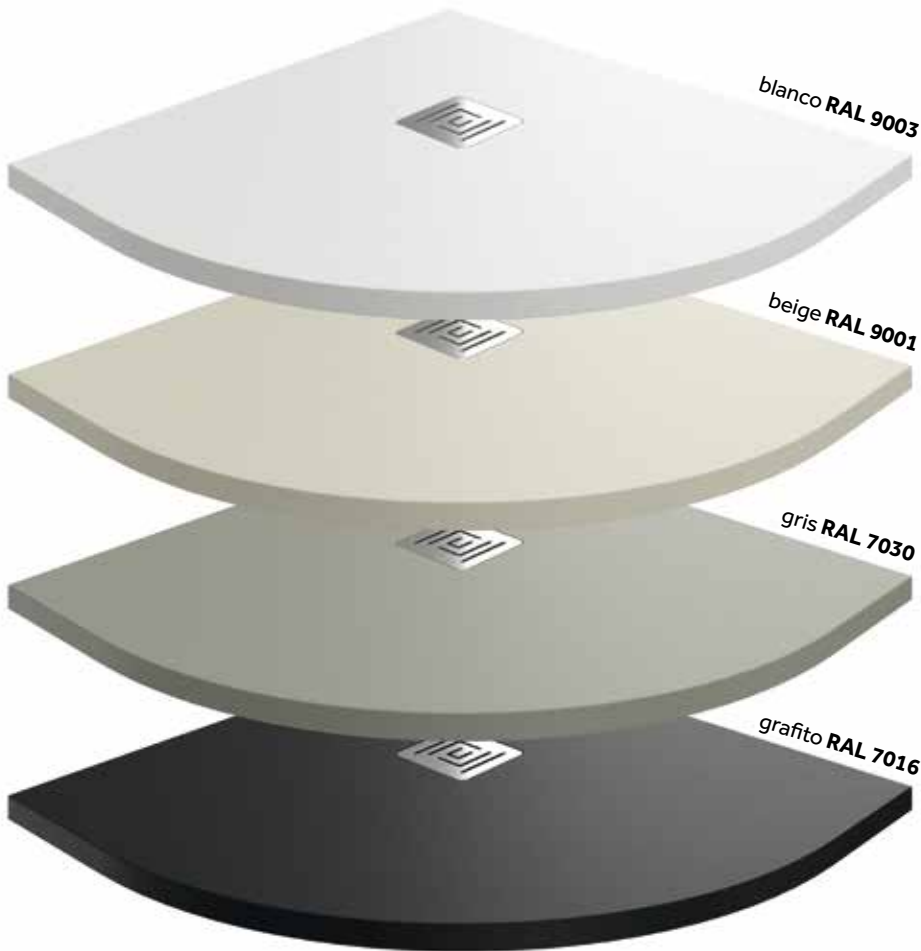

REJILLA BLANCA
ref. 0382BL
+14 puntos



REJILLA NEGRA
ref. 0382NG
+14 puntos



REJILLA BEIGE
ref. 0382BE
+14 puntos



REJILLA GRIS
ref. 0382GR
+14 puntos



REJILLA ORO
ref. 0382OR
+14 puntos



REJILLA COBRE
ref. 0382CB
+14 puntos



REJILLA NÍQUEL
ref. 0382NK
+14 puntos



REJILLA TITANIO
ref. 0382T
+14 puntos

SEMICIRCULAR RADIO STANDARD R 55

	BLANCO	GRAFITO	BEIGE	GRIS	Puntos
80x80	3820	3822	3824	3826	229
90x90	3821	3823	3825	3827	276

*Incluye válvula standard extraplana con fijación tornillos + rejilla Inox 316 color Inox de 2 mm

PLATOS A MEDIDA Y CORTE

(necesario plano técnico)

Platos a medida tarifados según medida inmediata superior
ej. 175x76 PV.P. = 180X80 + corte **7777/8888**

- Cortes **con acabado Gel Coat** ref. **7777 / 25 puntos**

*Plazo de entrega 7 días

- Cortes **sin acabado Gel Coat** ref. **8888 / gratuito**

*Plazo de entrega 5 días

*Esta opción solo cuando el corte va oculto en la pared

Style Plus

Carga mineral última generación, textura pizarra
Gel Coat Sanitario ISO NPG

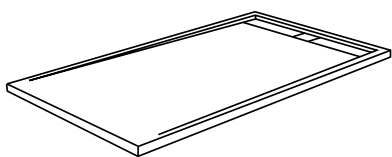
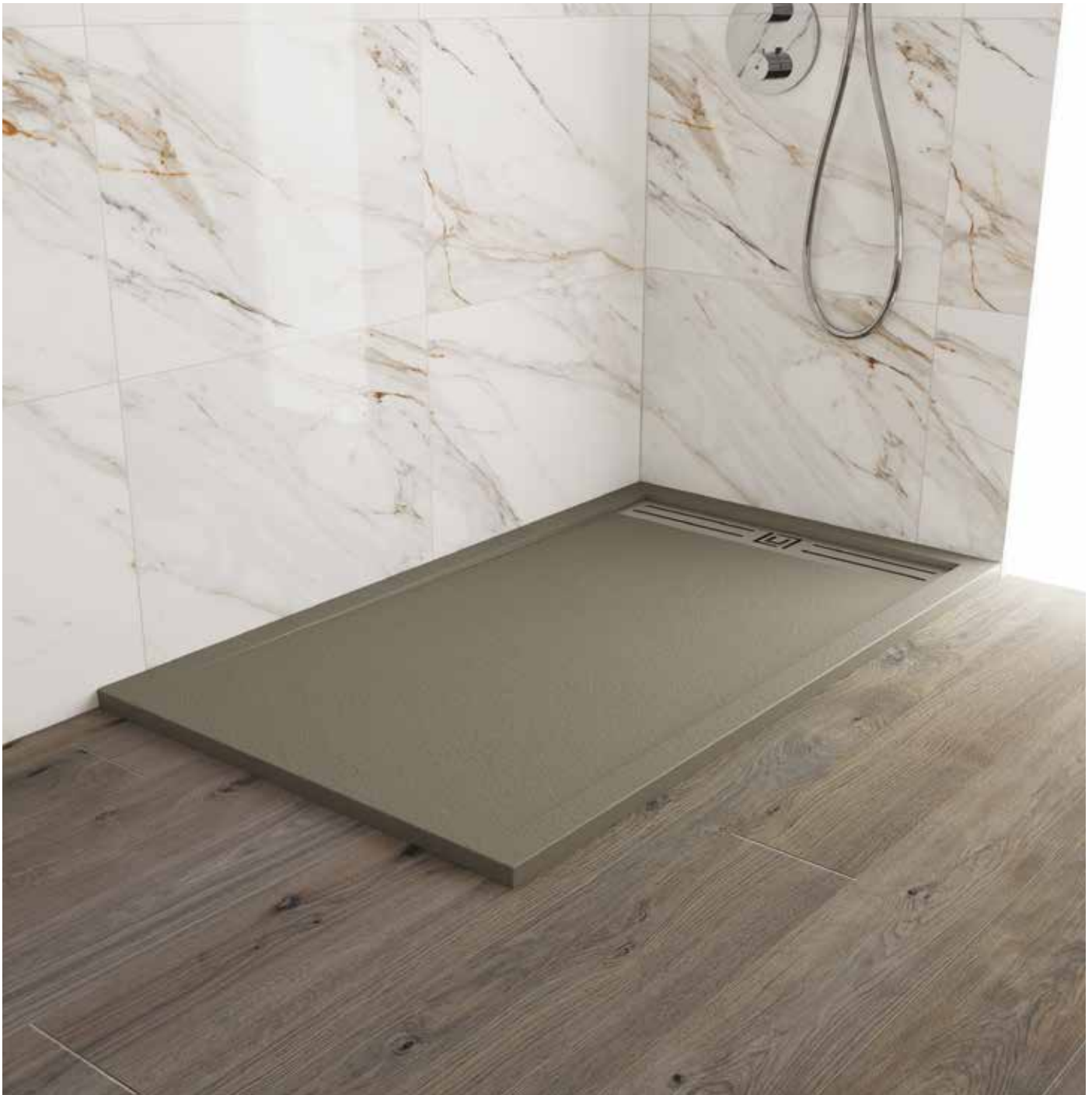

Distancia a válvula

ancho 70/80 cm **12 cm**

ancho 90 cm **14 cm**



Cualquier otro color de la carta RAL **+80 puntos**

Se sirve con rejilla inox

Plazo medio de entrega **25 días**

(No se aceptarán anulaciones una vez cursado el pedido)



	BLANCO	GRAFITO	BEIGE	GRIS	puntos
90x70	4886	4887	4888	4889	321
100x70	4900	4918	4936	4954	332
110x70	4901	4919	4937	4955	342
120x70	4902	4920	4938	4956	353
130x70	4903	4921	4939	4957	363
140x70	4904	4922	4940	4958	374
150x70	4905	4923	4941	4959	384
160x70	4906	4924	4942	4960	395
170x70	4907	4925	4943	4961	405
180x70	4908	4926	4944	4962	416
190x70	4972	4974	4976	4978	437
200x70	4973	4975	4977	4979	447
<hr/>					
100x80	4909	4927	4945	4963	342
110x80	4910	4928	4946	4964	353
120x80	4911	4929	4947	4965	363
130x80	4912	4930	4948	4966	374
140x80	4913	4931	4949	4967	384
150x80	4914	4932	4950	4968	395
160x80	4915	4933	4951	4969	405
170x80	4916	4934	4952	4970	416
180x80	4917	4935	4953	4971	426
190x80	4980	4982	4984	4986	447
200x80	4981	4983	4985	4987	458
<hr/>					
120x90	4840	4849	4858	4867	437
130x90	4841	4850	4859	4868	479
140x90	4842	4851	4860	4870	489
150x90	4843	4852	4861	4871	521
160x90	4844	4853	4862	4872	531
170x90	4845	4854	4863	4873	584
180x90	4846	4855	4864	4874	594
190x90	4847	4856	4865	4875	668
200x90	4848	4857	4866	4876	678

*Incluye válvula standard extraplana con fijación tornillos + rejilla Inox 316 color Inox de 2 mm

PLATOS A MEDIDA Y CORTE

Platos a medida tarifados según medida inmediata superior ej. 175x76 P.V.P. = 180X80 + corte **7777/8888**

OPCIONES CORTE

ref. **7777** / Cortes con acabado Gel Coat / 25 puntos

*Plazo de entrega 7 días

ref. **8888** / Cortes sin acabado Gel Coat / gratuito

*Plazo de entrega 5 días

*esta opción solo cuando el corte va oculto en la pared



CERTIFICADO CLASE 3
Máxima Calificación
ANTIDESLIZANTE

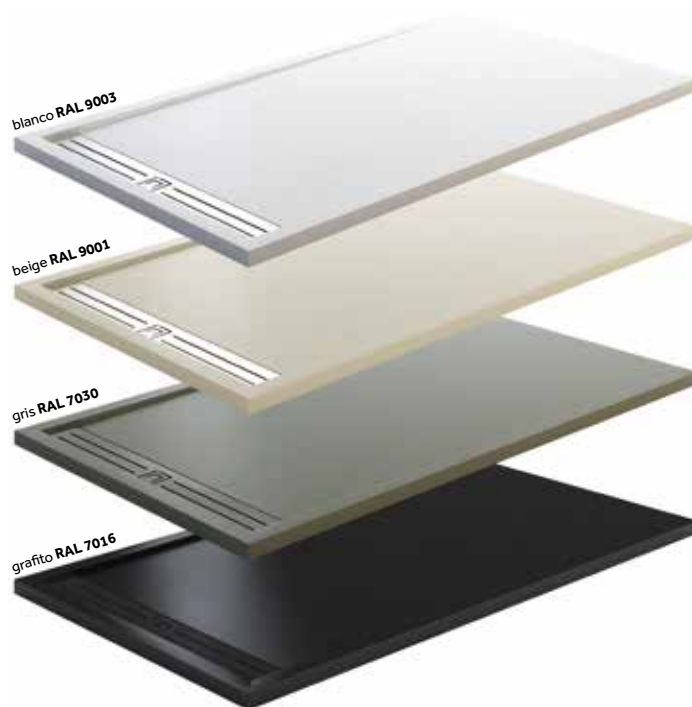

Rejilla Style color

Tamaño/color	INOX COLOR	RESINA
Rejilla 70 Blanca	0383BL70	0380BL70
Rejilla 80 Blanca	0383BL80	0380BL80
Rejilla 90 Blanca	0383BL90	0380BL90
Rejilla 70 Beige	0383BE70	0380BE70
Rejilla 80 Beige	0383BE80	0380BE80
Rejilla 90 Beige	0383BE90	0380BE90
Rejilla 70 Gris	0383GR70	0380GR70
Rejilla 80 Gris	0383GR80	0380GR80
Rejilla 90 Gris	0383GR90	0380GR90
Rejilla 70 Grafito	0383NG70	0380NG70
Rejilla 80 Grafito	0383NG80	0380NG80
Rejilla 90 Grafito	0383NG90	0380NG90



REJILLA COLOR
+35 puntos



REJILLA RESINA
+40 puntos

NUEVOS PLATOS ENMARCADOS ARDESIA PLUS

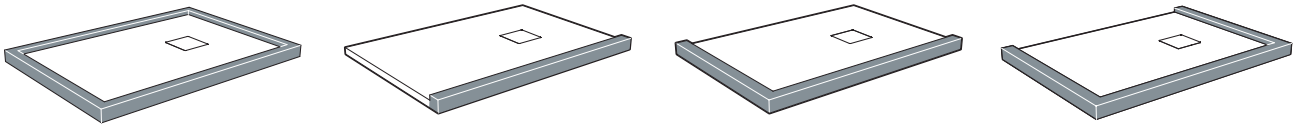

Descripción	Referencia	Puntos
Metro lineal enmarcado 4x4 cm std	0970	50m/l

Necesario plano técnico.

Para calcular los puntos de un plato con marco, sumar al punto del plato, los puntos de los metros lineales de enmarcado. El marco tendrá unas medidas de 4x4 si no se especifica.

Plazo de entrega aproximado 15 días.

RECAMBIOS PLATOS DE DUCHA

REJILLAS



Rejilla Inox Ardesia
9 Puntos



Rejilla Inox Style 70
24 Puntos
Rejilla Inox Style 80
26 Puntos
Rejilla Inox Style 90
28 Puntos

REPUESTOS VÁLVULA



Válvula standard ref. 0372
15 Puntos



Sifón
5 Puntos



Cestillo
5 Puntos



Tapón sifón
3 Puntos

KITS REPARACIÓN



Kit pintura
20 Puntos
Kit pintura + masilla
24 Puntos
Kit pintura plato completo
50 Puntos



Conjunto gomas
3 Puntos

PANELES DE BAÑERA



NUEVOS PANELES ARDESIA PLUS +RÍGIDO +RESISTENTE

Paneles con fibra de vidrio y Gel Coat de 0,6 cm de grosor

Acabado [STYLE/ARDESIA](#)

Largo	Altura hasta 55		Altura 55 a 110	
	Referencia	Puntos	Referencia	Puntos
Hasta 70 cm	1411	71	1415	144
De 71 cm a 100 cm	1412	102	1416	205
De 101 cm a 140 cm	1413	144	1417	288
De 141 cm a 208 cm	1414	225	1418	399

Plazo entrega aprox. 15 días

ZÓCALOS

Zócalos de hasta 9 cm de altura, 23 puntos el metro lineal

Zócalos de hasta 9 cm a 15 cm de altura, 44 puntos el metro lineal

*Indicar Modelo / Medidas / Color

Plazo entrega aprox. 15 días

EXPOSITORES MAMPARAS

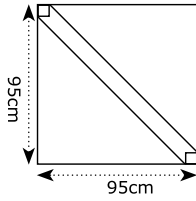

ref. GME01
2 Mamparas de 90x90

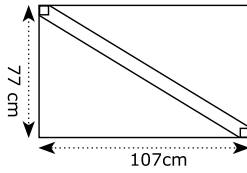

ref. GME02
2 Mamparas de 100x70

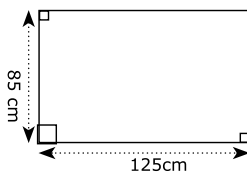

ref. GME04
3 Mamparas
mampara 120x80
open/akord 70
frontal 110

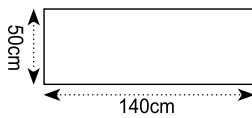

ref. GME07
3 Mamparas
frontal 140



ref. GME11

Exposición con mástiles de 2 m
en aluminio lacado blanco

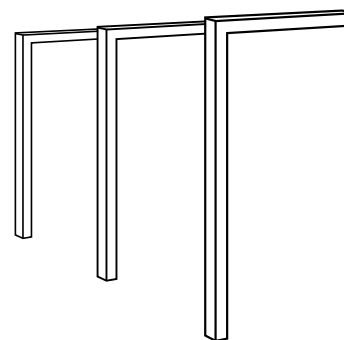

EXPOSITOR PLATOS



ref. GME06
2 platos 120x70
120x80



EXPOSITORES GRIFERÍA IO



ref. GME03
4 columnas o duchas vistas

ref. GME03+GME12
4 conjuntos grifería
2 duchas vistas/1 ducha+empotrable



ref. GME10
Medida 161x43x50 cm
6 grifos IO
1 ducha vista



ref. GME17
Medida 135x60x27 cm
3 grifos IO
2 duchas vista



ref. GME13
Medida 80x40 cm
9 grifos IO



ref. GME14
Medida 120x61 cm
14 grifos IO



ref. GME12
2 grifos IO



ref. GME16
Medida 30x30 cm
1 empotrable



ref. GME15
Medida 11x8 cm
1 grifo IO

IO[®] by GME

IO[®] es la marca registrada a nivel europeo de las griferías diseñadas y producidas por **GME División Baños S.L.** Con más de 30 años de experiencia en la comercialización y distribución de productos orientados al acondicionamiento integral del baño.

El grupo desarrolla dos líneas generales de negocio, una de ellas actúa como delegación de fabricantes de primer nivel, la otra, fabrica y comercializa productos bajo la marca **GME**.

Griferías **IO by GME** cuenta con todas las líneas de grifería necesarias para el acondicionamiento del baño y la cocina, con una gran variedad de formatos y 7 colores siguiendo las últimas tendencias del mercado. Acabados con tratamiento PVD en los colores metálicos con el mismo tono que nuestra variedad de mamparas de ducha color.

CONSULTA CATÁLOGO
GRIFERÍA IO



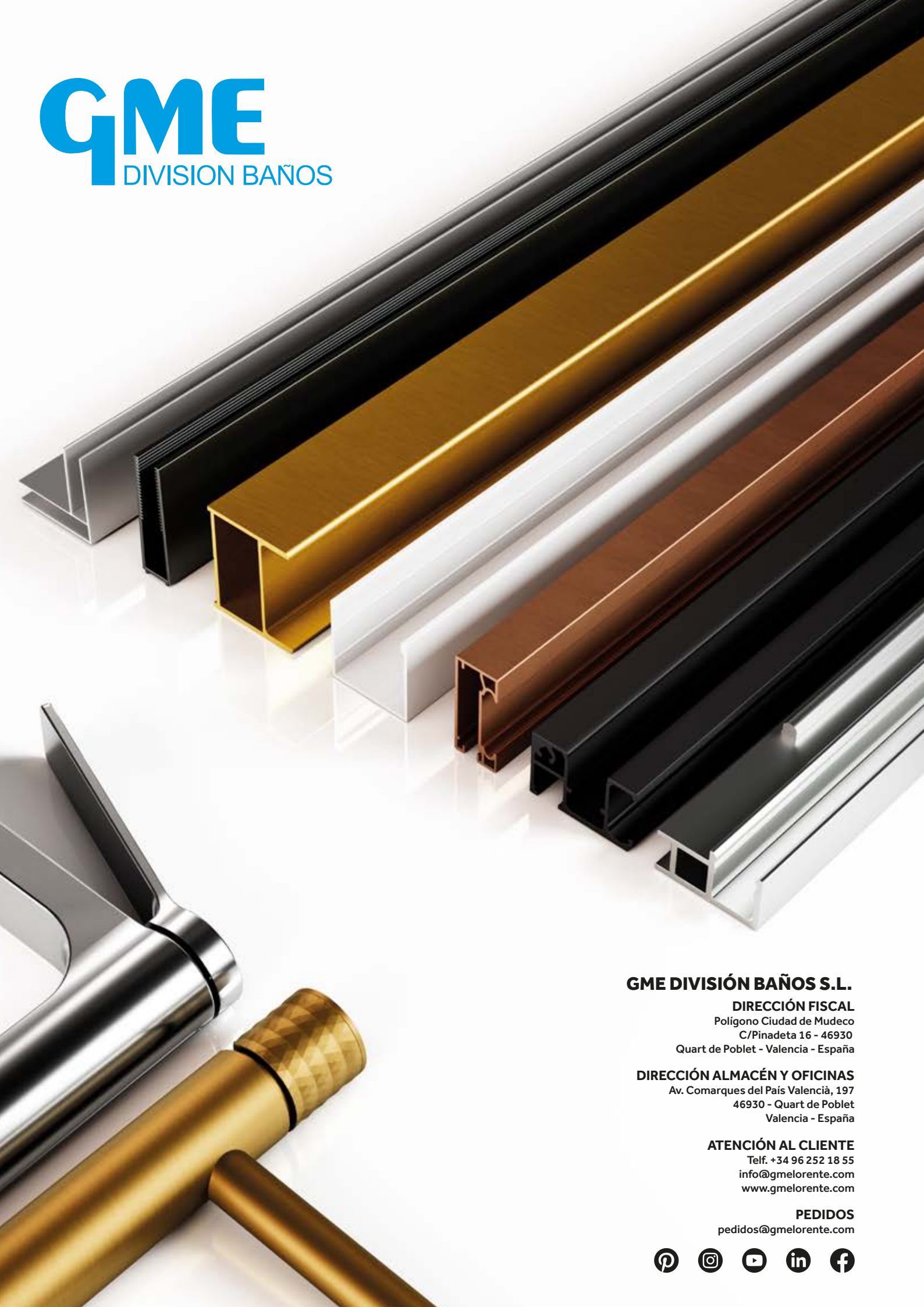

GME DIVISIÓN BAÑOS S.L.

DIRECCIÓN FISCAL

Polígono Ciudad de Mudeco

C/Pinadeta 16 - 46930

Quart de Poblet - Valencia - España

DIRECCIÓN ALMACÉN Y OFICINAS

Av. Comarques del País Valencià, 197

46930 - Quart de Poblet

Valencia - España

ATENCIÓN AL CLIENTE

Telf. +34 96 252 18 55

info@gmelorente.com

www.gmelorente.com

PEDIDOS

pedidos@gmelorente.com

